

**IS THERE RADON IN YOUR BASEMENT?
BUILD OUR RADIATION MONITOR AND
FIND OUT FOR SURE.**

JUNE 1988

15148783

Radio- Electronics®

TECHNOLOGY - VIDEO - STEREO - COMPUTERS - SERVICE

THE ULTIMATE CONTROL COMPUTER

BUILD A UNIVERSAL
INPUT/OUTPUT MODULE FOR
RE'S ADVANCED CONTROL SYSTEM

PLANT-WATER MONITOR

EASY-TO-BUILD MOISTURE
METER KEEPS TABS ON
YOUR GARDEN

DON LANCASTER

HARDWARE HACKER COLUMN:
HOW TO FIND PARTS FOR
YOUR PROJECTS AND MORE!

CALIBRATION STANDARDS

THE SEARCH FOR PERFECT
ACCURACY IN MEASUREMENT

COMPUTER DIGEST

A ROUNDUP OF MICE
MORE ON THE PT-68K

BUILD THIS RADIATION MONITOR

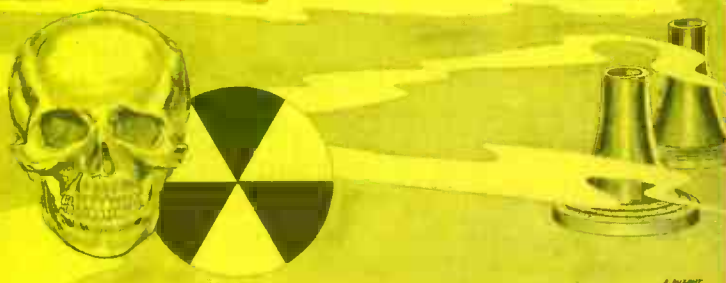

HANDHELD DETECTOR SENSES
ALPHA, BETA, GAMMA AND
X-RAY RADIATION.



\$2.25
IN CANADA \$2.75

A
GERNSBACK
PUBLICATION



THE ANSWER IS IN TEK DIGITAL STORAGE:

Now! The new 60 MHz Tek 2221 joins the world's best-selling family of digital storage oscilloscopes. All featuring 20 MS/s digitizing along with familiar, full-bandwidth analog operation. It's the best of both worlds in an easy-to-use portable.

Discover the potential. With digital storage you can freeze waveforms. Capture events invisible to nonstorage scopes. Find signals buried in noise. And build a library of reference waveforms.

Digital storage display accuracy enhances your confidence in measurements. And all you have to do is push a button for *real-time* display analysis.

Compare the 2230, 2221 and 2220 to each other—and all others. The new 2221 offers such advanced features as CRT readout and measurement cursors. For even more performance and flexibility, there's the 100 MHz, dual time base 2230 with optional battery-backed memory for saving up to 26 waveform sets. And if it's economy you want, choose the 60 MHz 2220 with many of the same features at an even lower cost.

\$2995
\$3995
\$4995

With each scope you can capture events as narrow as 100 ns at any sweep speed thanks to Tek's proprietary peak detect mode. View events prior to or following a trigger event with pre/post trigger. Store waveforms into 4K records. Automate measurements with optional GPIB and RS-232-C interfaces. And output direct to a printer or plotter.

Tek software is available to help you make the most of the 2230, 2221 and 2220 in system configurations.

Call Tek for a free video brochure or to place an order.

Ask about free digital storage application notes and educational materials. Orders include complete documentation, manuals and 3-year warranty on labor, parts and CRT.

**Call Tek direct:
1-800-426-2200**
for free video brochure for orders/assistance.

Features	2230	NEW! 2221	2220
Analog/Digital Storage BW	100 MHz	60 MHz	60 MHz
Maximum Sampling Speed	20 MS/s	20 MS/s	20 MS/s
Record Length	4K/1K (selectable)	4K	4K
Peak Detect	100 ns	100 ns	100 ns
Save Reference Memory	One, 4K Three, 1K	One, 4K	One, 4K
Vertical Resolution	8 bits 10 bits 12 bits (AVG mode over the bus)	8 bits 10 bits (AVG mode)	8 bits
CRT Readout/Cursors	Yes	Yes	No
GPIB/RS-232-C Options	Yes (\$750)	Yes (\$500)	Yes (\$500)
Battery-Backed Memory (save 26 waveform sets)	Yes (inc with GPIB/RS-232-C)	No	No
Price	\$4995	\$3995	\$2995



CIRCLE 92 ON FREE INFORMATION CARD

Prices subject to change without notice.
Copyright © 1987, Tektronix, Inc. All rights reserved. TXA-795E-1

www.americanradiohistory.com

Tektronix
COMMITTED TO EXCELLENCE

BUILD THIS

- 41 RADIATION MONITOR**
How safe are you? Build our super-sensitive, hand-held Geiger counter and find out for sure!
Joe Jaffe, Dan Sythe, and Steve Weiss

- 49 SOIL MOISTURE METER**
Keep your plants healthy with this inexpensive digital meter.
Ricardo Jimenez and Clemente Garcia

- 51 Radio Electronics ADVANCED CONTROL SYSTEM**
Part 5. Put REACTS to work in the real world.
H. Edward Roberts, M.D.

TECHNOLOGY

- 57 ALL ABOUT CALIBRATION**
New accuracy standards for ohms, volts, amperes, and time.
Vaughn D. Martin

COMPUTERS

- 87 MICROCOMPUTING MICE**
A round-up of those popular devices.
Jeff Holtzman

- 93 BUILD THE PT-68K**
Basic DRAM theory.
Peter A. Stark

DEPARTMENTS

- | | |
|--|--|
| <ul style="list-style-type: none">6 VIDEO NEWS
What's new in this fast changing field.
David Lachenbruch
26 EQUIPMENT REPORTS
A.W. Sperry's <i>VH-600</i> Voltage Detector.
38 STATE OF SOLID STATE
Linear IC's.
Robert F. Scott
65 HARDWARE HACKER
Finding parts.
Don Lancaster | <ul style="list-style-type: none">71 DRAWING BOARD
Z80 hardware.
Robert Grossblatt
74 AUDIO UPDATE
Getting the noise out of FM.
Larry Klein
78 SHORTWAVE RADIO
What makes shortwave possible.
Stanley Leinwoll
80 ANTIQUE RADIOS
Drawing radio schematics.
Richard D. Fitch |
|--|--|

COMPUTER DIGEST

A NEW KIND OF MAGAZINE FOR ELECTRONICS PROFESSIONALS
MICROCOMPUTER MICE
A market roundup Page 87



CD CLASSROOM
Dynamic RAM in the PT-68K Page 93
MULTIMODE VIDEO GRAPHICS
Hands-on look at Orchid's Designer VGR Page 86

PAGE 85

ALL ABOUT CALIBRATION



THE QUEST FOR PERFECT MEASUREMENTS
New accuracy standards for ohms, volts, amperes, and time
VAUGHN D. MARTIN

Responsible editor: Vaughn D. Martin. The author is a freelance writer and editor. He has written for many technical magazines and books. He is currently working on a book about calibration. He can be reached at Vaughn@calibration.com.

PAGE 57

AND MORE

- 118 Advertising and Sales Offices**
- 118 Advertising Index**
- 14 Ask R-E**
- 119 Free Information Card**
- 22 Letters**
- 99 Market Center**
- 32 New Products**
- 62 PC Service**
- 4 What's News**

ON THE COVER



Chernobyl and Three Mile Island are not just scary headlines from far-away places—a nuclear accident can affect *all* our lives. Maybe your neighborhood is home to a nuclear power plant, or you worry about radiation that might be emitted by common household objects. Since we can't see or feel the radiation that could be so dangerous, how can you know if there is cause for alarm? You can find out by building the Geiger counter we present on page 41. With it you'll be able to test radiation levels, detect nuclear-plant leaks by monitoring radiation levels, and even sound an alarm if the level is abnormally high. Gain knowledge—and peace of mind—by building our radiation monitor.

COMING NEXT MONTH

THE JULY ISSUE
IS ON SALE
JUNE 2

BUILD A RADIATION DETECTOR

Part 2 describes how to use the detector most effectively.

L/C METER

Build an auto-ranging digital inductance/capacitance meter.

Radio Electronics ADVANCED CONTROL SYSTEM

Applications using the universal I/O module.

COMPUTER DIGEST

Build a line-carrier modem.

As a service to readers, RADIO-ELECTRONICS publishes available plans or information relating to newsworthy products, techniques and scientific and technological developments. Because of possible variances in the quality and condition of materials and workmanship used by readers, RADIO-ELECTRONICS disclaims any responsibility for the safe and proper functioning of reader-built projects based upon or from plans or information published in this magazine.

Since some of the equipment and circuitry described in RADIO-ELECTRONICS may relate to or be covered by U.S. patents, RADIO-ELECTRONICS disclaims any liability for the infringement of such patents by the making, using, or selling of any such equipment or circuitry, and suggests that anyone interested in such projects consult a patent attorney.

RADIO-ELECTRONICS, (ISSN 0033-7862) June 1988. Published monthly by Gernsback Publications, Inc., 500-B Bi-Country Boulevard, Farmingdale, NY 11735 Second-Class Postage paid at Farmingdale, NY and additional mailing offices. Second-Class mail registration No. 9242 authorized at Toronto, Canada. One-year subscription rate U.S.A. and possessions \$17.97, Canada \$23.97, all other countries \$26.97. All subscription orders payable in U.S.A. funds only, via international postal money order or check drawn on a U.S.A. bank. Single copies \$2.25. © 1988 by Gernsback Publications, Inc. All rights reserved. Printed in U.S.A.

POSTMASTER: Please send address changes to RADIO-ELECTRONICS, Subscription Dept., Box 55115, Boulder, CO 80321-5115.

A stamped self-addressed envelope must accompany all submitted manuscripts and/or artwork or photographs if their return is desired should they be rejected. We disclaim any responsibility for the loss or damage of manuscripts and/or artwork or photographs while in our possession or otherwise.

Radio-Electronics®

Hugo Gernsback (1884-1967) founder
M. Harvey Gernsback,
editor-in-chief, emeritus

Larry Steckler, EHF, CET,
editor-in-chief and publisher

EDITORIAL DEPARTMENT

Art Kleiman, editorial director
Brian C. Fenton, editor
Carl Laron, WB2SLR, associate editor
Jeffrey K. Holtzman, computer editor
Marc Spiwak, associate editor
Jonathan A. Gordon, assistant technical editor
Robert A. Young, assistant editor
Julian S. Martin, editorial associate
Byron G. Wels, editorial associate
M. Harvey Gernsback, contributing editor
Jack Darr, CET, service editor
Robert F. Scott, semiconductor editor
Herb Friedman, communications editor
Robert Grossblatt, circuits editor
Larry Klein, audio editor
David Lachenbruch, contributing editor
Don Lancaster, contributing editor
Richard D. Fitch, contributing editor
Teri Scaduto, editorial assistant

PRODUCTION DEPARTMENT

Ruby M. Yee, production director
Robert A. W. Lowndes, editorial production
Andre Duzant, technical illustrator
Karen Tucker, advertising production
Marcella Amoroso, production traffic

CIRCULATION DEPARTMENT

Jacqueline P. Cheeseboro, circulation director
Wendy Alanko, circulation analyst
Theresa Lombardo, circulation assistant

Typography by Mates Graphics
Cover photo by Herb Friedman
Cover illustration by Andre Duzant

Radio-Electronics is indexed in *Applied Science & Technology Index* and *Readers Guide to Periodical Literature*.

Microfilm & Microfiche editions are available. Contact circulation department for details.

Advertising Sales Offices listed on page 118.



Don't make your customers hate their VCR's guts.

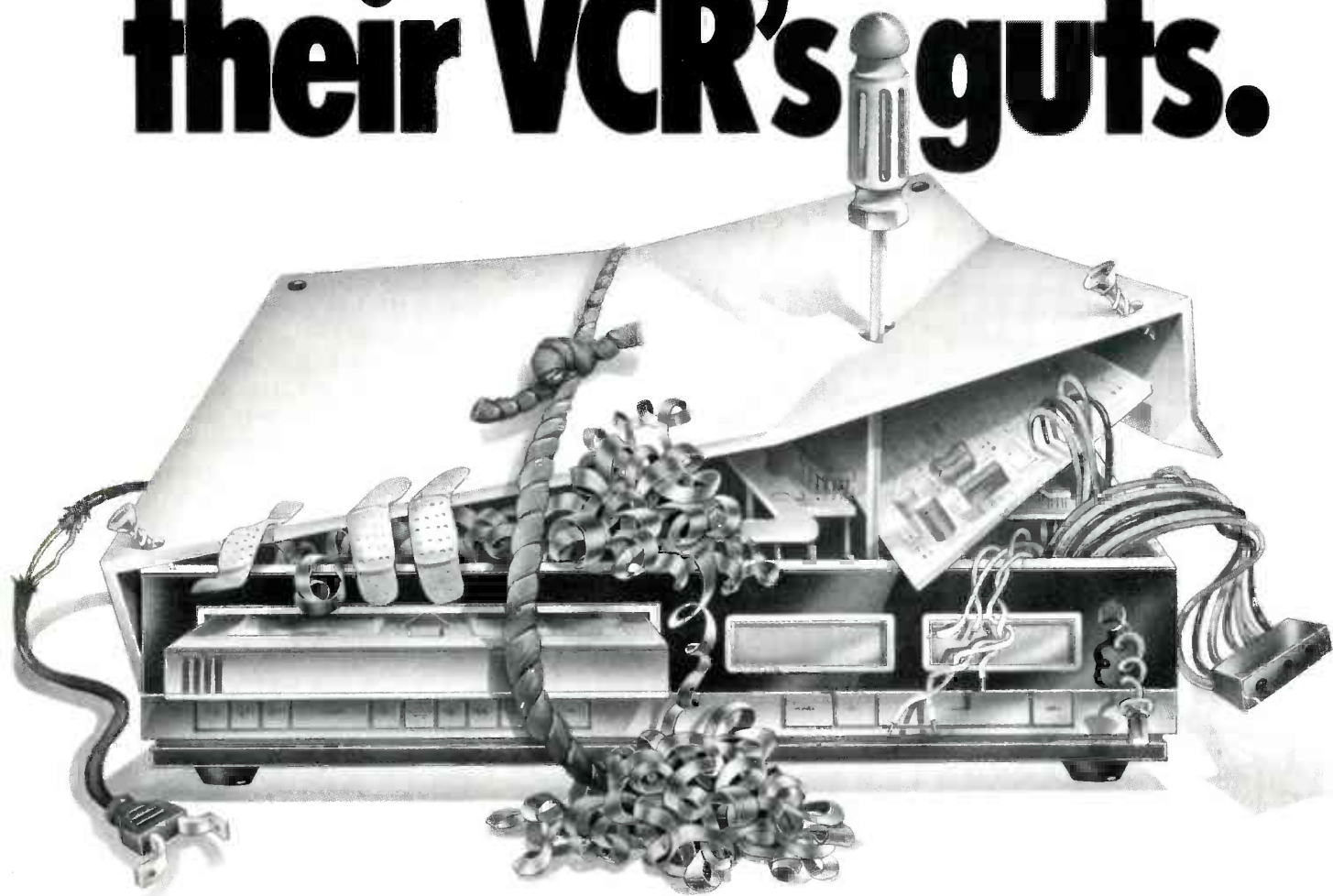

Use authentic RCA/GE brand exact replacement parts.

The last thing your customers want to see after having their VCRs repaired is an instant replay of the original problem.

But that's what can happen when you use off-brand replacement parts. Mailings from unknown discounters may offer incredibly low prices. Brochures from unproven aftermarket manufacturers may look very attractive, too. But that second-rate quality and service may also cost you your customers.

That's why you should depend on RCA/GE exact replacement parts for VCRs. No one in the industry offers a wider, more reliable product line. With RCA/GE parts you'll not only keep your customers happy, you'll also keep them loving their VCRs — inside and out.

To learn more, see your local RCA/GE Parts Distributor. Or write: Thomson Consumer Electronics, Sales Promotion Services, Distributor and Special Products, 2000 Clements Bridge Road, Deptford, N.J. 08096-2088.

RCA 
VCR Replacement Parts

WHAT'S NEWS

CBS Copycode found "inadequate"

Following a five-month test program, an encoding system proposed by CBS records to prevent prerecorded music from being copied by new Digital Audio Tape (DAT) recorders was found inadequate on three counts according to a report issued by the National Bureau of Standards (NBS).

The NBS tests found that CBS' Copycode (1) sometimes permitted the recording of material that was encoded to prevent recording, and sometimes prevented the recording of unencoded material; (2) altered the recorded material in a way that was discernible for some listeners during some selections; and (3) easily could be defeated through the use of external signal conditioning. The NBS found five different ways to defeat or circumvent the encoding scheme, each of which would be easy to build, and cost on the order of \$100.

While the NBS report may effectively kill the Copycode scheme, it may not be the end of DAT copy protection. Other schemes have been proposed, including one by Kahn Communications (Westbury, NY) that will not allow prerecorded tapes to be played back on tape recorders not equipped to prevent recording of copyrighted material.

Computer security standard reaffirmed for five years

The NBS has reaffirmed use of Data Encryption Standard (DES) for another five years, describing it as a "sound and economical method for protecting valuable but unclassified data." (The standard, adopted by the NBS in 1977, is reviewed by the Bureau and the Secretary of Commerce every five years.)

The standard is used in both government and the private sector

to protect data transmitted between or stored in computers. It is widely used for protecting transfers of funds and securities over transmission lines, which is a process known as electronics funds transfer.

Federal Information Processing Standard Publication 46, *Data Encryption Standard*, is available from the National Technical Information Service, Springfield, VA 22161, for \$9.95 prepaid.

Home-video sales expanded throughout 1987

According to the EIA (Electronic Industries Association), sales of home-video products in 1987 outpaced those in 1986.

In a report released at the end of last November, the EIA said that 1987 sales to that date exceeded those in 1986 by 6%. VCR sales were up 2.5% and camcorder sales were up by 36%. That increase came despite a sluggish November, during which many items sold for prices that were below those realized in 1986.

Format agreement moves video telephone nearer

A number of Japanese companies have recently demonstrated "video telephones" that allow callers to see each other. (The images are still pictures, and the two parties cannot talk during the picture transmission—about five to six seconds.) However, the existence of two incompatible formats (one developed by Mitsubishi and supported by Matsushita and NEC, and the other developed by Sony), made the possibility of a format war—reminiscent of the fight between VHS and Beta videotape formats—very real.

Now, thanks to an agreement between Sony and Mitsubishi, that war appears to have been averted. Under the agreement, the two camps will develop and adopt a

new standard that's a compromise between the two existing ones. The agreement has been tentatively approved by Japan's Telegraph and Telephone Committee. The four companies expect to be marketing the telephones before the middle of next year.

New Humidity meter has quick comeback

National Bureau of Standards scientist Peter H. Huang has obtained U.S. patent No. 4,681,855 for an instrument to sense and measure humidity; it overcomes a major problem that exists in present devices.

One of the weaknesses in commercial humidity-measuring equipment is known as *hysteresis*. That is the inability to return to zero immediately when measuring abrupt humidity changes. Many instruments may be accurate at a given humidity level, say 50 per cent. But if used at the 100-percent level and then quickly returned to 50 per cent, they may not measure reliably.

Huang bases his instrument on a halogen-based polymer such as Teflon. On that he deposits, as a film, the "tuner" of the system—a strong- and weak-acid mixture. Best results have been had with sulfonic and carboxylic acids. Because the ratio of the two acids determines the rate at which water is purged from the polymer, hysteresis problems can be virtually eliminated.

The polymer is measured electronically or weighed in order to determine its water content—and thus the humidity.

Dr. Huang says he will continue with the invention and that the National Bureau of Standards welcomes industrial inquiries or collaborative research. Contact Peter H. Huang, B312 Physics Bldg., National Bureau of Standards, Gaithersburg, MD 20899. **R-E**

HITACHI SCOPES AT DISCOUNT PRICES!

\$100 Price Reduction

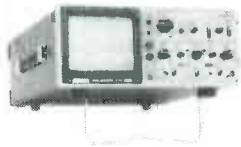

V-212
NOW \$379
was \$475
List \$560

Plus 'Free' 9600 Function Generator

All Hitachi scopes include two 1x, 10x probes and have a 3 year warranty on parts and labor



40MHz **V-425** List 995
CRT readout **\$835**



60MHz **V-660** List 1,195
Delayed sweep **\$899**

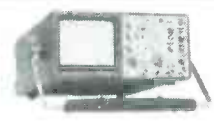

100MHz **V-1060** List 1,595
Delayed sweep **\$1,285**

	List	Our Price	Save
V-223 20MHz D.T. 2mV Sens. Delayed Sweep	770	695	75
V-422 40MHz D.T. 1mV Sens. DC offset	875	695	180
V-423 40MHz D.T. 1mV Sens. Delayed Sweep DC offset	955	795	160
V-1065 100MHz D.T. 2mV Sens. Delayed Sweep	1,895	1,575	320
V-1100 100MHz Q.T. 1mV Sens. Cursor meas. DVM counter	2,295	1,995	300
V-1150 150MHz Q.T. 1mV Sens. Cursor meas. DVM counter	3,100	2,565	535

ELENCO PRODUCTS AT DISCOUNT PRICES!

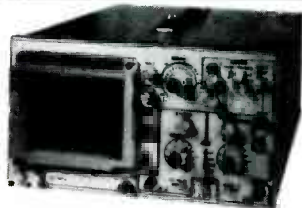

\$349
MO-1251

- 6" CRT
- Built in component tester
- TV Sync
- Much More

20MHz Dual Trace Oscilloscope

MO-1253

- 40MHz Dual Trace
- Dual Time Base
- Delayed Sweep
- 12KV Acceleration Voltage
- Better than Hitachi V-423
- High Luminance 6" CRT

\$595



\$498
MO-1252

- High Luminance 6" CRT
- 1mV Sensitivity
- 6KV Acceleration Voltage
- 10ns Rise Time
- X-Y Operation • Z Axis
- Delayed Triggering Sweep
- Much More

35MHz Dual Trace Oscilloscope

Top quality scopes at a very reasonable price. Contains all desired features. Two 1x, 10x probes, diagrams and manual.



True RMS 4 1/2 Digit Multimeter
\$135 M-7000

.05% DC Accuracy
.1% Resistance with Freq. Counter & Deluxe Case



10MHz Oscilloscope
S-3000
\$239

10MHz DC or AC Triggered Sweep
Calibrated Vert & Hor
Reads Volts & Freq

Scope Probes

P-1 65MHz, 1x, 10x 19.95
P-2 100MHz, 1x, 10x 23.95
10 meg ohms input impedance
Fits most scopes
TL-3 BNC to Minigrabber 3.49



Low Cost Multimeter
M-1600
\$25

3 1/2 Digit LCD
1% DC Accuracy
10A Scale
Auto zero/polarity



Digital LCR Meter
LC-1800
\$138

Measures
Coils (1uH-200H)
Caps (.1pf-200uf)
Resistors
(.1 ohm-20M ohms)

Breadboard

9436 Shown



9430 1,100 pins \$15
9434 2,170 pins \$25
9436 2,860 pins \$35



Multimeter with Capacitance and Transistor Tester
\$55 CM-1500A

Reads Volts, Ohms
Current, Capacitors,
Transistors and
Diodes w/case

Digital Capacitance Meter
CM-1550
\$58.95

9 Ranges
.1pf-20,000ufd
5% basic accuracy
Zero control
w/case



Analog Multimeter
M-1100
\$19.95

19 ranges
High Accuracy
10A reading
Mirrored scale
Kit 17.50



3 1/2 Digit Meter
Auto and Manual Ranging
28 Functions
Fully Protected

M-1180 .7% Ac \$36.95
M-1181 .1% Ac \$42.95
M-1182 .25%Ac \$39.95

Function Generator Blox

#9600
\$24.95

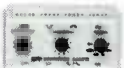

Provides sine, tri, squ wave
From 1Hz to 1MHz
AM or FM capability

Solderless Breadblox



550 tie pts
including 2 power
bus lines
#9550
\$7.50

IC Test Clips

16 pin \$5.95
20 pin \$8.25
24 pin \$10.75
28 pin \$11.75
40 pin \$18.50

All are gold plated to assure trouble free contact

Temperature Probe

M-110CF
\$29.95

Semiconductor type
Range
-58F-302F
Fits most digital multimeters

50MHz Logic Probe



LP-700
\$23

Digital 3 Amp Power Supply



XP-750
\$175

0-40V @ 1.5A
0-2V @ 3A

XP-650 with Analog Meters \$129.50

Regulated P.S. Breadboard

\$99.95 XK-400

- Fully regulated
- Short circuit protection
- 3550 test points
- 3 power supplies

• 5V @ 2A, 12V @ .3A, -12V @ .3A

GF-8016 Function Generator with Freq. Counter



\$239

- Sine, Square, Triangle
- Pulse, Ramp, .2 to 2MHz
- Frequency 1 thru 10MHz

GF-8015 without Freq. Meter \$179

Digital Triple Power Supply



XP-765
\$239

0-20V @ 1A
0-20V @ 1A
5V @ 5A

Fully Regulated, Short Circuit Protected with 2 Limit Cont. 3 Separate Supplies

XP-660 with Analog Meters \$169.50

Quad Power Supply



XP-580
\$59.95

Fully regulated and short circuit protected

XP-575 without meters \$49.95

Four-Function Frequency Counters

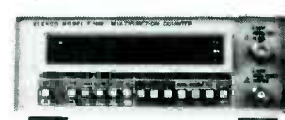

F-1000 \$259
1.2GH

F-100 \$179
120MH

Frequency, Period, Totalize, Self Check with High-Stabilized Crystal Oven Oscillator, 8 Digit LED Display

WE WILL NOT BE UNDERSOLD!



C & S SALES INC.

1245 Rosewood, Deerfield, IL 60015
Add 5% for Postage (\$10 Max) IL Res., 7% Tax

(800) 292-7711

(312) 541-0710

15 Day Money Back Guarantee

2 Year Warranty

ASK FOR FREE CATALOG

CIRCLE 109 ON FREE INFORMATION CARD

VIDEO NEWS



DAVID LACHENBRUCH,
CONTRIBUTING EDITOR

● **8mm "Hi-Band."** The 8mm format's answer to Super VHS and ED Beta wasn't long in coming. Ten Japanese manufacturers, led by Hitachi, Matsushita, and Sony, have announced the development of a super high-resolution version of the 8mm format, which is being turned over to the Electronic Industries Association of Japan for standardization. Although detailed specifications weren't announced, the developing group said 8mm "Hi-Band" will produce a picture with more than 400 lines of horizontal resolution, which is about the same as Super VHS, but somewhat lower than the 500 lines of ED Beta.

Like both of the other high-resolution systems, Hi-Band is "forward compatible"—that is, a Hi-Band VCR can play back a standard 8mm tape, but a standard 8mm recorder can't play back a Hi-Band tape. Hi-Band uses a new "high performance" metal videotape, has a wider video response, and its output—like that of S-VHS and ED Beta—consists of separate Y and C (luminance and chrominance) signals. Its proponents say the system is designed as an option and doesn't replace standard 8mm; it should be on the market some time in 1989.

● **"True Digital" VCR's.** The so-called "digital" home VCR's of today are, of course, misnamed—they merely have digital memory for special effects, such as picture-in-picture, clean freeze, slow-motion, and so forth. However, true digital videotape recorders are already being offered by Sony, Ampex, and others for broadcast and teleproduction use, and Japanese consumer-products companies are hard at work extending the technology to home VCR's.

Sony has announced a major step toward the true digital home VCR—Adaptive Dynamic Range Coding, a method of compressing a 216-megabit-per-second signal to 30 megabits, making it possible to record 90 minutes of digital video signal on an 8mm metal-particle tape, with little or no noticeable degradation.

Sony says it's about halfway to the point of a practical digital consumer recorder, and that compression of the signal to 15 megabits and further improvement in heads and tape could

make the goal of true digital recording for consumer use feasible within four years.

However, when it will reach the marketplace is another matter. Digital recording's greatest virtue, the ability to make nearly perfect recordings, time after time, almost certainly will cause its introduction to be opposed by the entertainment industry. Opposition from that industry has already delayed the introduction of digital audio tape in this country.

● **LCD TV's improving.** What once was a curiosity is now evolving into a legitimate product, as color liquid-crystal displays have improved to the point where they can be used as truly watchable miniature TV screens. Previously, only Panasonic's three-inch *Pocket Watch* provided a display with sufficient quality. Subsequently, both Sharp and Magnavox introduced very good versions with 2.7-inch displays (both displays made by Sharp). Now Hitachi has introduced a 2.7-inch color monitor (without tuner), designed to clip onto a camcorder. It also contains an audio amplifier, speaker, and volume control; and it can serve as a viewfinder for recording, or a monitor for playback. Sony also plans to introduce a tiny combination 3.3-inch LCD color-TV set and 8-mm recorder this year.

● **3D camcorder.** You will soon be able to make stereoscopic 3D home movies of your loved ones popping out of the TV screen—that is, if Toshiba goes through with its plans to market a 3D camcorder to consumers. The camcorder, which uses the compact VHS-C cassette, weighs only 3.7 pounds, although it has two CCD pickup-and-lens assemblies. It requires LCD viewing glasses that are connected to the VCR and synchronized so that each eye sees an alternate picture field. To eliminate flicker, the number of fields is doubled to 120 per second, so each eye sees 60-frames per second. Toshiba says that the system will first be marketed for educational, commercial, and industrial uses, and will go on the consumer market when costs come down enough to offer it for around \$2,000.

R-E

If You Need Electronic Tools & Test Equipment, You Need Tools•4•U.

We created Tools•4•U to give you the best possible prices on the tools you need. Just pick up the phone and give us a call. You can use your Mastercard or

Visa or send us a check. We ship most orders the same day! So get your tools & test equipment fast and easy... Give us a call TODAY!

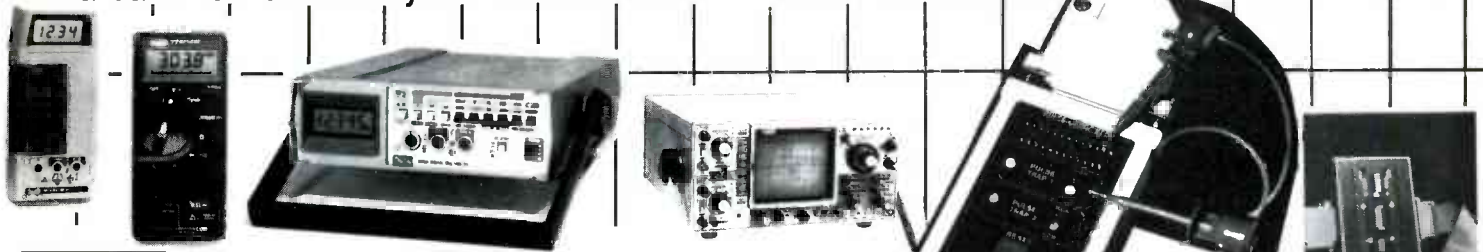

FLUKE

		Retail Price	Sale Price
77	DMM w/Cont. Beeper, Touch Hold, Auto & Man. Ranging	\$145.00	\$120.00
75	DMM w/Cont. Beeper	\$109.00	\$95.95
73	DMM with Autoranging	\$79.00	\$63.75
8020B	8 Function DMM	\$219.00	\$176.60
8021B	6 Function DMM	\$169.00	\$144.95
8024B	11 Function DMM, w/Peak Hold, Logic Test & Temp.	\$259.00	\$208.95
8026B	True RMS, Hand Held DMM	\$229.00	\$184.66
8050A	Bench DMM, 4 1/2 Dig., True RMS, w/dBm.	\$399.00	\$321.75
8060A	4 1/2 Digit DMM, w/dB, dBm, & True RMS.	\$369.00	\$297.95
80T-150U	Universal Temp. Probe; Converts Any Fluke DMM to Temp. Probe.	\$120.00	\$96.95
C-70	Multipurpose Holster for 20, 50 & 70 Series DMM's.	\$10.00	\$8.95
C-86	Hard Case For Bench DMM's	\$20.00	\$16.12
Y8134	Deluxe Test Lead Kit	\$22.00	\$17.75
Y8140	Slim-Flex Test Leads	\$20.00	\$16.12
C-90	Soft Case For 20, 50 & 70 Series DMM's.	\$13.00	\$10.50
37	Bench/Portable Multimeter	\$249.00	\$199.95

All Fluke Products Come With A 2 Year Warranty



Beckman Industrial™

310	3 1/2 Digit Handheld DMM, w/10A Current Range	\$145.00	\$116.95
320	3 1/2 Digit Handheld DMM, w/Continuity Check	\$179.00	\$144.95
330	3 1/2 Digit Handheld DMM, w/True RMS	\$219.00	\$177.95
HD110	3 1/2 Digit, Drop Proof, HD Overload Protection, Contamination Proof DMM.	\$199.00	\$160.47
HD110T	Same as HD110 w/Temp. Probe	\$219.00	\$177.95
LP10A	17MHz, Pulse Memory, Selectable TTL, DTL, HTL or CMOS Logic Probe	\$17.95	\$13.95
SM-2	IC & Component Tester. Tests Most Electronic Components In Or Out Of Circuit; Works w/any X-Y Mode Oscilloscope	\$395.00	\$308.16
DL243	Deluxe Test Lead Kit	\$17.25	\$13.13

BK PRECISION

		Sugg Retail	Sale Price
2120	Dual Trace 20MHz Oscilloscope	\$546.95	\$385.92
1420	15MHz, Dual Trace, Field Portable Mini-Oscilloscope, w/battery pack	1047.00	\$740.73
1590AP	100MHz, Quad Trace, Oscilloscope	2150.00	1520.64
PR-37	Deluxe 10:1/REF/1:1 Oscilloscope Probe	\$53.95	\$40.00
PR-46	Deluxe 10:1 Oscilloscope Probe	\$74.95	\$54.83
2125	20MHz, Dual Trace Oscilloscope w/Delayed Sweep/Dual Time Base	\$535.00	\$459.64
810A	3 1/2 Digit Handheld Capacitance Meter w/LCD Readout	\$137.50	\$101.95
830	3 1/2 Digit Autoranging Capacitance Meter	\$302.50	\$222.23
550	IC Comparator Tester/Logic Monitor w/TTL Integrated Circuits	\$434.50	\$319.95
552	IC Comparator Tester/Logic Monitor for CMOS Integrated Circuits	\$434.50	\$319.95
1541A	40 MHz, Dual Trace Oscilloscope	1006.00	\$738.43
3011	2 MHz Function Generator w/Digital Display	\$240.95	\$821.00
1805	80 MHz Multifunction Counter, 5Hz to 80 MHz, w/8 Digit LED Display.	\$350.00	\$259.20
1645	9-16VDC, 0-10A Single Output Power Supply	\$192.50	\$141.69
540	Component Tester w/CRT	1094.50	\$802.94

DATATRAN CORPORATION

		Retail Price	Sale Price
DT-4	Datatracker: 100 LED Breakout Box & Cable Tester w/case & manual.		\$239.95
CTA-7	Cable Test Adapter, Loops Test Signals From Datatracker Back to Datatracker		\$29.95
GM-MM	Gendermate, Male. Allows Connection of Mismatched Connectors		\$19.95
GM-FF	Gendermate, Female. Allows Connection of Mismatched Connectors		\$19.95
UC-4	4' Universal Cable		\$39.95
UC-8	8' Universal Cable		\$44.95
MT-1	Minitracker, Miniature RS-232 Signal Monitor, 16 LED's. Monitors the 8 Most Used RS-232 Lines		\$29.95
MT-2	Minitracker Plus, Miniature RS-232 Signal Monitor, 24 Pairs of LED's. Monitors the 24 Most Used RS-232 Lines.		\$49.95
MP-1	Micropatch: Male-to-Female; Custom Interface Without Cutting, Stripping, Crimping or Soldering.		\$29.95
MP-2	Micropatch: Same as MP-1 except Male-to-Male		\$29.95
MP-3	Micropatch: Same as MP-1 except Female-to-Female		\$29.95
PT-1	RS-232 Pulse-Tracker, Can Detect Pulse or Data on 2 Signal Lines Simultaneously.		\$49.95
SP11	Spike Surge Protector, Data Line Surge Protector, Protects the 11 Most Commonly Used Lines		\$34.95

Sale!

ungar

UTC100 Electronic Soldering System, w/variable 400-800° F temp. \$77.95 \$55.95



INTERNATIONAL DATA SCIENCES, INC.

LINCOLN, R.I., U.S.A.



60	EIA Interface Monitor & Breakout Box	\$159.00	\$148.00
61	Tri-State LED EIA Breakout Box	\$225.00	\$209.00

TRIPLETT

3525A	Digi-Probe, Pocket Sized DMM, w/autoranging, 4 Functions & 16 Ranges	Retail Price \$55.00	Sale Price \$41.95
310	Hand Size, Analog VOM	\$63.00	\$51.95
2030	Pocket Size, Autoranging DMM, w/3 1/2 Digit	\$35.95	\$24.95



SHIPPING & HANDLING

\$2.70-order up to \$15.00
 \$3.70-order of \$15.01 to \$25.00
 \$4.90-order of \$25.01 to \$50.00
 \$6.90-order of \$50.01 to \$100.00
 \$7.90-order over \$100.00

TOOLS•4•U

A Division of W.S. Jenks & Son
 1933 Montana Ave. N.E. Washington D.C. 20002

SHOP
 TOLL-FREE

1-800-638-6405

MasterCard • Visa

NEW

Only NRI gives you a 27" high-resolution stereo color TV you build to prepare you for today's video servicing careers.



Become one of America's most sought-after technicians . . . put your talents and spare time to work for you in the "explosive-growth" world of home entertainment electronics.

Train in state-of-the-art video/audio servicing and become a fully qualified service professional the uniquely successful NRI way. It's hands-on training, at home . . . designed around the latest electronic equipment you build and keep as part of your training. You start from scratch and "discover by doing." You conduct key experiments . . . perform vital tests . . . build your own systems . . . and do it all at the pace that suits you best.

There's no stopping the incredible boom in consumer electronics. Soaring sales, new and improved video products, entirely new technologies have opened up new opportunities for the trained technician as never before.

Now at \$26 billion in annual sales, the consumer electronics industry is creating a whole new servicing, installation, and repair market. This year, TV sales alone are expected to hit 16.2 million units. Every day, sales of home

VCRs, a product barely conceived of 10 years ago, reach 20,000 units. Every day!

And the revolution has spread to the business sector as tens of thousands of companies are purchasing expensive high-tech video equipment used for employee training, data storage, even video conferencing.

The Video Revolution Is Just Starting

Already, disc players can handle audio CDs and laser video discs. And now there are machines that will accommodate laser computer disks as well. Camcorders are becoming smaller, lighter, and more versatile. . . . 8 mm video equipment produces high-resolution pictures and digital audio. By 1990 our TVs will become interactive computer terminals, giving us entertainment, information, and communications in one sophisticated video/computer/audio system.

Join the Future or Be Left Behind

Can you see the opportunity? The servicing and repair market that's there already . . . and the enormous future created by the millions upon millions of electronic devices yet to come? If you're looking for a high-potential career . . . if you'd like to get started in a field that's still wide open for the independent businessperson . . . even if you'd like to find a way to make extra money part-time, look into NRI at-home training now.

Start Right and There'll Be No Stopping You!

NRI training in video/audio servicing is the perfect way for you to profit from the new explosive growth in consumer electronics. You study at home in your spare time at your own pace. No classroom pressures, no night school grind.

Even if you've never had electronics training, NRI prepares you properly with a thorough grounding in the fundamentals . . . a foundation that you build on to achieve advanced electronics skills. With this kind of understanding and practical bench experience built into NRI's exclusive training methods, you're on your way to take advantage of the new opportunities opening up every day.

Totally Integrated Hands-On Training

Since NRI training is built around "learn by doing," right from the start you conduct important experiments and tests with your professional digital multimeter. You assemble the remarkable NRI Discovery Lab and perform a complete range of demonstrations and experiments in the process.

Hands-On Training As You Build a 27" Stereo TV

In just hours you assemble an exceptional state-of-the-art TV receiver using easy to follow, step-by-step instructions. During this assembly process, you learn to identify and work with components and circuits used in actual commercial circuitry. Then through tests, adjustments, and experiments you quickly master professional troubleshooting and bench techniques.



NRI's commitment to you goes beyond providing you with equipment appropriate to the latest technology. Of equal importance is our dedication to training techniques that let you master TV, video and audio troubleshooting and repair quickly and easily. Best of all, we ensure that in the learning process you acquire the very skills that will make you a professional service technician on the job.

NRI has purposely designed your training around equipment that has the same high-tech circuitry you'll encounter in commercial equipment. That means your training is real-world training. And *that's* unique.

Inside Your TV

This new state-of-the-art Heath/Zenith 27" TV included with your training has all the features that allow you to set up *today* your complete home video center of the future. Flat screen, square corners, and a black matrix to produce dark, rich colors. Cable-compatible tuning, built-in stereo decoder to give you superb reproduction of stereo TV broadcasts . . . even a powerful remote control center that gives you total command of video and audio operating modes.

Your NRI Training Has Another Special Element

Also built into your training is the enormous experience of NRI development specialists and instructors. Their long-proven training skills and enthusiasm come to you on a one-to-one basis. Available for consultation and help whenever you need it, your instructors ensure your success both during your course and after graduation.

Step Into the Future Today

The richest reward you gain from your NRI video/audio training is a firm grip on the future. Your knowledge and know-how provide you with the soundest possible foundation for keeping up with the rapidly evolving, highly innovative video industry.

Send For Free Catalog

Now is the time to act. Send the post-paid card to us today. You'll receive our 100-page catalog free. It's filled with all the facts you'll want to know about our training methods with full details on the equipment you'll use and keep as part of your hands-on training. You'll see how our more than 70 years of experience in uniquely successful at-home career training makes us the leading technical school today. (If someone has already used the card, write to us at the address below.)

NRI Schools
McGraw-Hill Continuing
Education Center
3939 Wisconsin Avenue, NW
Washington, DC 20016



Sound Value.

Intelligent Design And Solid Construction Make The New HD 150 Series DMMs The Best In Their Class.

Auto-off feature prolongs battery life by shutting DMM off after one hour.

Large LCD is high-contrast, direct drive for easy-reading even at wide angles.

Thick-walled case of fire-resistant, high-impact Valox® the moplastics guarantee drop proof—as proven in 10-foot test drop to concrete floor.

Large rotary dial with auto-ranging speeds function selection. Center location permits one-handed (right or left) operation. Gold-plated beryllium copper contacts assure years of reliable use.

Positive temperature coefficient resistor (PTC) curbs overloads while in resistance mode.

Metal oxide varistor (MOV) protects DMM and user against high-transient voltage up to 6kV.

Two fuses guard against current overload. A high-energy 15A/600V fuse protects from over load on the 10A jack, while a 250mA/600V fuse protects against overload on the mA jack.

O-rings seal the entire case, rotary switch and input terminals. Entire meter is guaranteed for 5 years against contamination.

Easy access means more uptime and a more productive DMM. Remove four recessed screws, and you're ready to change fuses. The battery is just as easy to get to.



Breakthrough CMOS technology is responsible for increased accuracy, audible readout, and the speed with which measurements are displayed on the LCD.

At the heart of the HD 150 Series' new features is a powerful CMOS dual metal gate A/D converter. Designed by Beckman Industrial, this chip converts voltage to frequency, making possible the HD 150 Series' fast autoranging and audible readout.

This chip's measurements accurately reflect actual analog input, unlike competitive DMMs that repeatedly sample the input, then display a measurement that averages the samples. On the HD 150 Series, you get the true signal.

Value of Sound.

Introducing A Heavy-Duty DMM With An Audible Readout That Lets You Keep Both Eyes On The Job.



Hands-free operation comes from a range of features that make HD 150 Series DMMs a must for your tool box or bench: a tilt stand and Skyhook let you set or hang it almost anywhere. An audible readout lets you *listen* to measurements without touching the DMM. An intermittent alert pinpoints shorts.

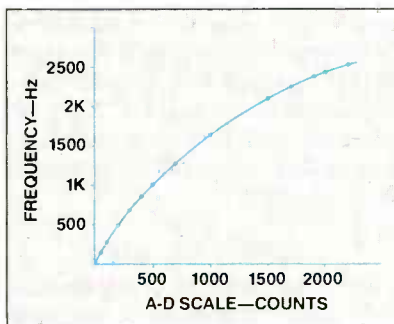

Audible readout. A “sound” reason to go with the HD 150 Series. With this unique feature on the HD 153, you measure parameters by listening to a continuous variable tone. As the parameters you measure rise or fall, the tone’s frequency will increase or decrease, accordingly. Use the audible readout to measure volts, amps or ohms. It’s ideal for peaking and nulling, too.

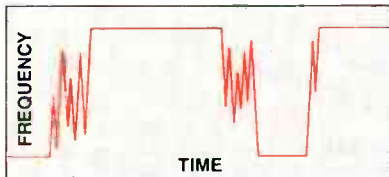

Intermittent alert. One key application of audible readout. The HD 153 pinpoints intermittents by emitting a “crackling” sound when they’re detected. The response sounds in about 1 msec—far faster than the information appears on any DMM display.

Logic function. The HD 153 detects TTL or CMOS logic pulses using standard test leads—and alerts you with a beep.

Specs that set the standard. The HD 150 Series is the latest in a distinguished line of instruments that began when Beckman Industrial pioneered heavy duty DMMs with their distinctive yellow color. Since then, many competitors have imitated that color. As for imitating their performance, no one comes close.

Easy to use. The HD 150 Series lets you read the LCD even at wide angles. A large rotary dial, full auto-ranging and a slim-styled case give you a solid grip on fast, one-handed function selection.

Built tough to work hard. The HD 150 Series DMMs are so tightly sealed against water and grime that they’re guaranteed for five years against contamination. And, because they’re built so tough, they’re guaranteed for two years against *any* damage (except abuse). Crashes, overloads, moisture, dust... you name it. The HD 150 Series can handle it all!



Listening is believing. For a hands-on demo, see your distributor now. Learn why the HD 150 Series is the soundest DMM value you’ll see. Or hear.

Key Specifications

	HD 151	HD 152	HD 153
Auto-ranging	✓	✓	✓
Range Lock		✓	✓
Audible readout			✓
Tilt Stand and Skyhook™	Optional	Optional	Included
Logic pulse detector			✓
DC voltage accuracy	0.7%	0.5%	0.25%
10A range		✓	✓
Suggested list price	\$149.00	\$169.00	\$199.00

In Service Instruments,
We're The One.

Beckman Industrial™

Beckman Industrial Corporation,
Instrumentation Products Division
A Subsidiary of Emerson Electric Company
3883 Ruffin Road, San Diego, California 92123-1898
(619) 495-3200 • FAX: (619) 268-0172 • TLX: 249031

© 1987 Beckman Industrial Corporation
Valox is a registered trademark of General Electric Corporation
Specifications subject to change without notice

CIRCLE 98 ON FREE INFORMATION CARD

ASK R-E

PENDULUM PROBLEMS

I'm rebuilding an old electric pendulum clock and I am missing the circuit that makes the pendulum swing back and forth. The pendulum has a magnet on it and the power supply originally fed a pulsing DC voltage to a coil that would make the pendulum move. Rather than work out the original design, is there some other circuit that I can use to generate a pulsing DC voltage between about 0.5 and 2 Hz from a 1.5 volt battery?—J.D.G., Ferry, CT.

It doesn't happen often, but every once in a while there's a simple answer to a circuit question. In this case, not only is there a really easy way to take care of the problem, but you can get everything you need from Radio Shack!

The circuit shown in Fig. 1 is built around the LM3909 IC. That IC was really designed to be an LED flasher but it can be used for other applications as well. You didn't specify how much power your coil needed, but once you've got the circuit operating, you can use a transistor to boost the output to whatever level you need.

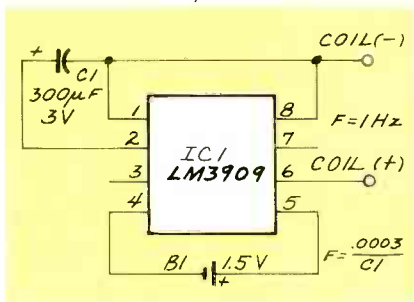

FIG. 1

The LM3909 can deliver 45-mA current pulses at more than 2 volts. You can vary the pulse rate by changing the capacitor C1 as indicated in Fig. 1. If you want to use a trimmer potentiometer to vary the pulse rate, use the circuit shown in Fig. 2.

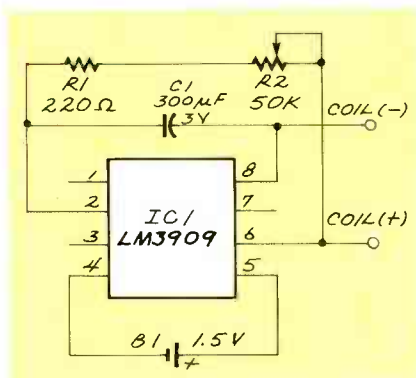

FIG. 2

The LM3909 can operate from a wide variety of supply voltages, and an alkaline D-cell battery should be able to power the IC for more than two years. Not bad.

DISK DILEMMA

You recently ran a series of articles on disk storage, but there's one point that wasn't clear. If the disk is organized as sectors on concentric tracks, aren't the sectors on the outermost tracks much larger than the ones near the center? If that is the case, and each sector holds the same amount of data, isn't there a lot of wasted space in the sectors near the outer part of the disk?—J.F., Chestnut Ridge, NY.

Simple geometry would seem to

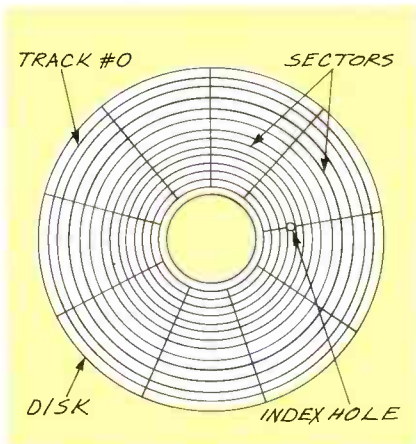

FIG. 3

WRITE TO:

ASK R-E
Radio-Electronics
500-B Bi-County Blvd.
Farmingdale, NY 11735

dictate that you're right, but disk-operating-system designers would disagree. Figure 3 shows a disk with its track and sector markings. If we're talking about a 9-sector IBM disk, the length of a track #0 sector is about 1.7 inches, and a track #40 sector is about 0.8 inches long. While it's true that there's a difference in length between the two sectors, it's not true that there's more empty space on the outer tracks.

The reason for that is because the data is being read from and written to the disk at a constant rate. And since the outer edge of the disk is moving faster than the center, there will be more space between data marks but they'll be presented to the drive's head at the same rate no matter what track is being accessed.

The critical parameter in disk storage is timing. The hardware that's doing the reading and writing expects to see pulses of a specific length. The outer tracks turn faster but the data is also spaced farther apart. If the disk-operating system wants to store a "1" as a 20-microsecond pulse, it's going to need more room on track #0 than on track #40.

VIDEO SIGNALS

I'm interested in experimenting with video circuits but I am having difficulty finding information on standard video signals. Could you describe the different parts of a video signal and let me know what sort of problems are involved when mixing two or more signals together or when switching from one to another.—D.R., Marianna, FL.

It's paradoxical, but the standard video signal is one of the most complex signals you'll ever come across. But, although video signals can have many variations,

uniden® CB Radios & Scanners

Communications Electronics™, the world's largest distributor of radio scanners, introduces new models of CB, radar detectors and scanners.

NEW! Bearcat® 760XLT-SA3

List price \$499.95/CE price \$279.95/SPECIAL 12-Band, 100 Channel • Crystalliss • AC/DC Frequency range: 29-54, 118-174, 406-512, 806-956 MHz. Excludes 823.9875-849.0125 and 868.9875-894.0125 MHz. The Bearcat 760XLT has 100 programmable channels organized as five channel banks for easy use, and 12 bands of coverage including the 800 MHz. band. You also get automatic scanning of preprogrammed aircraft, police, marine, and emergency services. It also includes Weather Search, Priority, Squelch, Lockout and Delay. It has automatic and manual band search to find new active frequencies in other areas of the radio spectrum. The Bearcat 760XLT mounts neatly under the dash and connects directly to fuse block or battery. The unit also has an AC adaptor, flip down stand and telescopic antenna for desk top use. 6-5/16" W x 1 1/4" H x 7 3/4" D. Model BC 580XLT-SA is a similar version without the 800 MHz. band for only \$219.95.

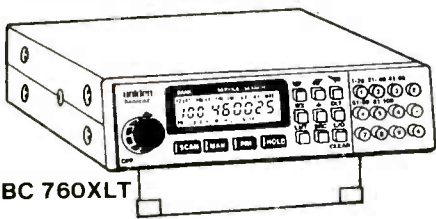

BC 760XLT

Regency® TS2-SA

List price \$499.95/CE price \$309.95/SPECIAL 12-Band, 75 Channel • Crystalliss • AC/DC Frequency range: 29-54, 118-175, 406-512, 806-950 MHz. The Regency TS2 scanner lets you monitor Military, Space Satellites, Government, Railroad, Justice Department, State Department, Fish & Game, Immigration, Marine, Police and Fire Departments, Aeronautical AM band, Paramedics, Amateur Radio, plus thousands of other radio frequencies most scanners can't pick up. The Regency TS2 features new 40 channel per second Turbo Scan™ so you won't miss any of the action. Model TS1-SA is a 35 channel version of this radio without the 800 MHz. band and costs only \$239.95.

Regency® RH256B-SA

List price \$799.95/CE price \$329.95/SPECIAL 16 Channel • 25 Watt Transceiver • Priority The Regency RH256B is a sixteen-channel VHF land mobile transceiver designed to cover any frequency between 150 to 162 MHz. Since this radio is synthesized, no expensive crystals are needed to store up to 16 frequencies without battery backup. All radios come with CTCSS tone and scanning capabilities. A monitor and night/day switch is also standard. This transceiver even has a priority function. The RH256 makes an ideal radio for any police or fire department volunteer because of its low cost and high performance. A 60 Watt VHF 150-162 MHz. version called the RH606B-SA is available for \$429.95. A UHF 15 watt, 10 channel version of this radio called the RU150B-SA is also available and covers 450-482 MHz. but the cost is \$419.95

SALE Bearcat® 100XL-SA

List price \$349.95/CE price \$159.95/CLOSEOUT 9-Band, 16 Channel • Priority • Scan Delay Search • Limit • Hold • Lockout • AC/DC Frequency range: 30-50, 118-174, 406-512 MHz. Uniden has authorized CEI to closeout the famous Bearcat 100XL to make room for new models. This scanner has a full 16 channels with frequency coverage that includes all public service bands. Wow... what a scanner! Included in our low CE price is a sturdy carrying case, earphone, battery charger/AC adaptor, six AA Ni-cad batteries and flexible antenna. Since this is a special closeout price on our last 200 pieces, you must order your Bearcat today to take advantage of this excellent scanner opportunity.

★★★ Uniden CB Radios ★★★

The Uniden line of Citizens Band Radio transceivers is styled to compliment other mobile audio equipment. Uniden CB radios are so reliable that they have a two year limited warranty. From the feature packed PRO 540e to the 310e handheld, there is no better Citizens Band radio on the market today.

- PRO310E-SA Uniden 40 Ch. Portable/Mobile CB ... \$85.95
- PRO330E-SA Uniden 40 Ch. Remote mount CB ... \$109.95
- NINJA-SA PRO310E with rechargeable battery pack \$99.95
- B-10-SA 1.2V AA Ni-cad battery for Ninja (set of 10) ... \$20.95
- KARATE-SA Uniden 40 channel rescue radio ... \$69.95
- PRO510E-SA Uniden 40 channel CB Mobile ... \$49.95
- PRO520E-SA Uniden 40 channel CB Mobile ... \$59.95
- PRO540E-SA Uniden 40 channel CB Mobile ... \$119.95
- PRO640E-SA Uniden 40 channel SSB/CB Mobile ... \$159.95
- PRO710E-SA Uniden 40 channel CB Base ... \$119.95
- PRO810E-SA Uniden 40 channel SSB/CB Base ... \$179.95

★★★ Uniden Radar Detectors★★★

Buy the finest Uniden radar detectors from CEI today.

- RD7-SA Uniden visor mount radar detector ... \$109.95
- RD9-SA Uniden "Passport" size radar detector ... \$129.95
- RD9XL-SA Uniden "micro" size radar detector ... \$159.95
- RD25-SA Uniden visor mount radar detector ... \$59.95
- RD500-SA Uniden visor mount radar detector ... \$79.95

NEW! Bearcat® 200XLT-SA

List price \$509.95/CE price \$299.95 12-Band, 200 Channel • 800 MHz. Handheld Search • Limit • Hold • Priority • Lockout Frequency range: 29-54, 118-174, 406-512, 806-956 MHz. Excludes 823.9875-849.0125 and 868.9875-894.0125 MHz. The Bearcat 200XLT sets a new standard for handheld scanners in performance and dependability. This full featured unit has 200 programmable channels with 20 scanning banks and 12 band coverage. If you want a very similar model without the 800 MHz. band and 100 channels, order the BC 100XLT-SA3 for only \$199.95. Includes antenna, carrying case with belt loop, ni-cad battery pack, AC adapter and earphone. Order your scanner now.

Bearcat® 800XLT-SA

List price \$549.95/CE price \$259.95/SPECIAL 12-Band, 40 Channel • No-crystal scanner Priority control • Search/Scan • AC/DC Bands: 29-54, 118-174, 406-512, 806-912 MHz. The Uniden 800XLT receives 40 channels in two banks. Scans 15 channels per second. Size 9 1/4" x 4 1/2" x 1 1/2". If you do not need the 800 MHz. band, a similar model called the BC 210XLT-SA is available for \$196.95.

Bearcat® 145XL-SA

List price \$189.95/CE price \$98.95/SPECIAL 10-Band, 16 Channel • No-crystal scanner Priority control • Weather search • AC/DC Bands: 29-54, 136-174, 406-512 MHz. The Bearcat 145XL is a 16 channel, programmable scanner covering ten frequency bands. The unit features a built-in delay function that adds a three second delay on all channels to prevent missed transmissions.

Bearcat® 175XL-SA

List price \$279.95/CE price \$156.95/SPECIAL 11-Band, 16 Channel • Weather Search Priority control • Search/Scan • AC/DC Bands: 29-54, 118-174, 406-512 MHz. The Bearcat 175XL has an automatic search feature to locate new frequencies. Priority, lock out, delay and scan speed are all included.

Regency® Informant™ Scanners

Frequency coverage: 35-54, 136-174 406-512 MHz. The new Regency Informant scanners cover virtually all the standard police, fire, emergency and weather frequencies. These special scanners are preprogrammed by state in the units memory. Just pick a state and a category. The Informant does the rest. All Informant radios have a feature called Turbo Scan™ to scan up to 40 channels per second. The INF1-SA3 is ideal for truckers and is only \$179.95. The new INF2-SA3 is a deluxe model and has ham radio, a weather alert and other exciting features built in for only \$219.95. For base station use, the INF5-SA3 is only \$129.95 and for those who can afford the best, the INF3-SA3 at \$149.95, is a state-of-the-art, receiver that spells out what service you're listening to such as Military, Airphone, Paging, State Police, Coast Guard or Press.

Regency® HX1500-SA

List price \$369.95/CE price \$179.95/SPECIAL 11-Band, 55 Channel • Handheld/Portable Search • Lockout • Priority • Bank Select Sidelit liquid crystal display • EAROM Memory Direct Channel Access Feature • Scan delay Bands: 29-54, 118-136, 144-174, 406-420, 440-512 MHz. The new handheld Regency HX1500 scanner is fully keyboard programmable for the ultimate in versatility. You can scan up to 55 channels at the same time including the AM aircraft band. The LCD display is even sidelit for night use. Includes belt clip, flexible antenna and earphone. Operates on 8 1.2 Volt rechargeable Ni-cad batteries (not included). Be sure to order batteries and battery charger from the accessory list in this ad.

★★★ Uniden Cordless Phones★★★

A major consumer magazine did a comparison study on cordless phones. The check points included clarity, efficiency and price. Uniden was rated best buy.

- XE300-SA Uniden Cordless Phone ... \$69.95
- XE500-SA Uniden Cordless Phone with paging ... \$84.95
- XE700-SA Uniden Cordless Phone with speaker ... \$114.95

★★★ Extended Warranty Program★★★

If you purchase a scanner, CB, radar detector or cordless phone from any store in the U.S. or Canada within the last 30 days, you can get up to three years of extended warranty service from Warrantech. This service extension plan begins after the manufacturer's warranty expires. Warrantech will perform all necessary labor and will not charge for return shipping. Extended warranties are non-refundable and apply only to the original purchaser. Two year extended warranty on a mobile or base station is \$29.99 and three years is \$39.99. For handheld scanners, 2 years is \$59.99 and 3 years is \$79.99. For radar detectors, two years is \$29.99. For CB radios, 2 years is \$39.99. For cordless phones, 3 years is \$34.99. Order your warranty for your merchandise today.

OTHER RADIOS AND ACCESSORIES

- BC 55XL-SA Bearcat 10 channel scanner ... \$114.95
 - BC 70XL-SA Bearcat 20 channel scanner ... \$169.95
 - R1090-SA Regency 45 ch. scanner ... CLOSEOUT \$119.95
 - Z60-SA Regency 60 ch. scanner ... CLOSEOUT \$129.95
 - UC102-SA Regency VHF 2 ch. 1 Watt transceiver ... \$117.95
 - BP55-SA Regency 16 amp. reg. power supply ... \$169.95
 - MA549-SA Drop-in charger for HX1200 & HX1500 ... \$84.95
 - MA518-SA Wall charger for HX1500 scanner ... \$14.95
 - MA553-SA Carrying case for HX1500 scanner ... \$19.95
 - MA257-SA Cigarette lighter cord for HX121/1500 ... \$19.95
 - MA917-SA Ni-Cad battery pack for HX1000/1200 ... \$34.95
 - BP205 Ni-Cad battery pack for BC200/BC100XL ... \$49.95
 - B-8-SA 1.2 V AA Ni-Cad batteries (set of eight) ... \$17.95
 - FB-E-SA Frequency Directory for Eastern U.S.A. ... \$14.95
 - FB-W-SA Frequency Directory for Western U.S.A. ... \$14.95
 - ASD-SA Air Scan Directory ... \$14.95
 - SRF-SA Survival Radio Frequency Directory ... \$14.95
 - TSG-SA "Top Secret" Registry of U.S. Govt. Freq. ... \$14.95
 - TIC-SA Techniques for Intercepting Comm. ... \$14.95
 - RRF-SA Railroad frequency directory ... \$14.95
 - ECS-SA Embassy & Espionage Communications ... \$14.95
 - CIE-SA Covert/Intelligent, Elect. Eavesdropping ... \$14.95
 - MFF-SA Midwest Federal Frequency directory ... \$14.95
 - A80-SA Magnet mount mobile scanner antenna ... \$35.95
 - A70-SA Base station scanner antenna ... \$35.95
 - USAMM-SA Mag mount VHF ant. w/ 12' cable ... \$39.95
 - USAK-SA 3/4" hole mount VHF ant. w/ 17' cable ... \$35.95
 - USAK450-SA 3/4" hole mount UHF ant. w/ 17' cable ... \$35.95
- Add \$3.00 shipping for all accessories ordered at the same time. Add \$7.00 shipping per radio and \$3.00 per antenna.

BUY WITH CONFIDENCE

To get the fastest delivery from CE of any scanner, send or phone your order directly to our Scanner Distribution Center. Michigan residents please add 4% sales tax or supply your tax I.D. number. Written purchase orders are accepted from approved government agencies and most well rated firms at a 10% surcharge for net 10 billing. All sales are subject to availability, acceptance and verification. All sales on accessories are final. Prices, terms and specifications are subject to change without notice. All prices are in U.S. dollars. Out of stock items will be placed on backorder automatically unless CE is instructed differently. A \$5.00 additional handling fee will be charged for all orders with a merchandise total under \$50.00. Shipments are F.O.B. Ann Arbor, Michigan. No COD's. Most products that we sell have a manufacturer's warranty. Free copies of warranties on these products are available prior to purchase by writing to CE. Non-certified checks require bank clearance. Not responsible for typographical errors.

Mail orders to: Communications Electronics™ Box 1045, Ann Arbor, Michigan 48106 U.S.A. Add \$7.00 per scanner for R.P.S./U.P.S. ground shipping and handling in the continental U.S.A. For Canada, Puerto Rico, Hawaii, Alaska, or APO/FPO delivery, shipping charges are three times continental U.S. rates. If you have a Discover, Visa or Master Card, you may call and place a credit card order. Order toll-free in the U.S. Dial 800-USA-SCAN. In Canada, order toll-free by calling 800-221-3475. FAX anytime, dial 313-971-6000. If you are outside the U.S. or in Michigan dial 313-973-8888. Order today.

Scanner Distribution Center™ and CEI logos are trademarks of Communications Electronics Inc. † Bearcat is a registered trademark of Uniden Corporation. ‡ Regency and Turbo Scan are registered trademarks of Regency Electronics Inc. AD #041588-SA3 Copyright © 1988 Communications Electronics Inc.

For credit card orders call
1-800-USA-SCAN

**COMMUNICATIONS
ELECTRONICS INC.**

Consumer Products Division
P.O. Box 1045 □ Ann Arbor, Michigan 48106-1045 U.S.A.
For orders call 313-973-8888 or FAX 313-971-6000

CIRCLE 79 ON FREE INFORMATION CARD

they are all composed of two basic parts: the image and the control signals. The timing and voltage relationships between them depend on the particular kind of video you're talking about (NTSC, PAL, etc.), but the same components are present in all of them.

The basis of most video systems is the horizontal line that is traced by the electron beam as it moves from left to right across the screen. After each line is finished, the beam is turned off, moved back to the left, down one line, turned back on, and the process starts over again. After all of the lines on the screen are drawn (the exact number of lines depends on the standard), the beam is moved back to the upper left and starts all over again. Each full screen of video is referred to as a "field".

Figure 4 is a representation of a typical line of video, and you can see that it has several basic parts. The complexity is what makes it difficult to mix or switch two separate signals. Picture information can be combined any way you

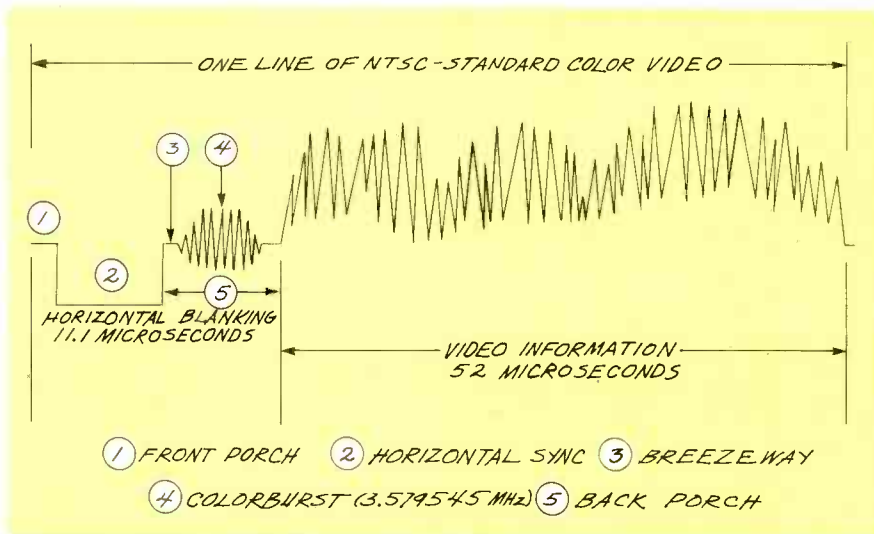

FIG. 4

want, but there can be only one set of control (or sync) signals. In order to mix two video signals, you first have to separate the picture from the control signals. Once you've done that, the combined picture has to be locked onto another set of control signals.

However complicated that sounds, there's a further consideration to keep in mind. You have

to make sure that the two sets of picture information are in sync—the start of picture #1 has to be exactly on top of the start of picture #2. That means that you have to use some part of the original control signals to find the beginning of each picture. You can use the edge of the blanking signal, the horizontal sync, or whatever for that.

R-E



Prototyping Made Easy. In The Quantities You Require.

Your Electronic Specialty Products distributor has a wide selection of 3M breadboards and prototyping labs in the quantities and styles you desire.

We invented solderless breadboarding with one thought in mind: "make it fast and easy!" And we build these products with American made reliability.

Whether your requirements demand 3M's A·C·E 100 Series solderless breadboards or Powerace prototyping labs with self-contained power supplies, or our newest Powerace labs

with removable boards, you'll find what you need at your authorized 3M Electronic Specialty Products distributor.

For educators, students, hobbyists and even professional designers, 3M prototyping products make circuit building and testing fun and easy. And whether you need one breadboard or a hundred, we've got them packaged as you need them.

Your Electronic Specialty Products distributor also has all the prototyping tools you'll need. Tools such as jumper wires, adaptor pins and patch cords.

For the name of your nearest 3M A·C·E Board and Powerace distributor, call toll free 800-321-9668 or (216) 354-2101 in Ohio.

**Electronic Specialty Products
3M Electronic Products Division**

9325 Progress Parkway
Mentor, Ohio 44060

We've Packaged Our Solutions.



CIRCLE 76 ON FREE INFORMATION CARD

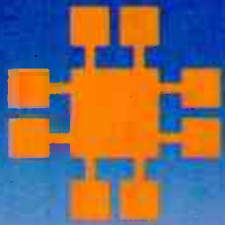

JDR INSTRUMENTS™

Complete customer satisfaction... superior service... friendly, knowledgeable personnel... quality merchandise... providing the best values in leading edge technology.

FULLY OVERLOAD PROTECTED

TRANSISTOR TESTER

9 FUNCTIONS 34 RANGES

CONDUCTANCE TESTER ADDS VERSATILITY

TEMPERATURE TESTER TO 2000° F



Our DMM-300
A remarkable value!
7995

This full function 3.5 digit DMM offers highly accurate performance and a host of added features to help you do the job—fast. Capacitance, transistor, temperature, conductance and audible continuity in addition to the ranges you'd expect from a DMM of this quality. Temperature probe, test leads and battery included. Input impedance: 10M ohm. Basic DC accuracy: plus/minus 0.25%. Approx. 7" x 3 1/2" x 1 9/16" Wt. 13 1/2 ozs.

DC VOLTAGE TO 1000 VOLTS

AC/DC CURRENT 200µA TO 10A

CAPACITANCE TESTER 2000pF TO 20µF

DPM-1000 **\$54.95**
3.5 DIGIT PROBE TYPE DMM

Custom 80 pin LSI chip provides accuracy and reliability in such a compact size. Autoranging, audible continuity and data hold feature help you pinpoint the problem quickly. Case and batteries included.

- Basic DC accuracy: plus/minus 1%
- DC voltage: 2v-500v, autoranging
- AC voltage: 2v-500v, autoranging
- Resistance: 2k ohms-2M ohms, autoranging
- Fully over-load protected
- Input impedance: 11M ohm
- Approx. 6 1/2" x 1" x 9/16" Under 3 ozs.



- ★ **2 YEAR REPLACEMENT WARRANTY**
- ★ **30 DAY MONEY BACK GUARANTEE**
- ★ **TOLL FREE TECHNICAL SUPPORT**
- ★ **NEXT DAY AIR SHIP AVAILABLE**

MODEL 2000 **\$389.95**
20 MHz DUAL TRACE OSCILLOSCOPE

Model 2000 makes frequency calculation and phase measurement quick and easy. The component tester aids in fast troubleshooting. Service technicians appreciate the TV Sync circuits for viewing TV-V and TV-H and accurate synchronization of the video signal, Blanking, VITS, and V/H sync pulses.

- Exceptionally bright 5" CRT
- Built-in component tester
- TV Sync filter
- X-Y operation • 110/220 volts

MODEL 3500 **\$499.95**
35 MHz DUAL TRACE OSCILLOSCOPE

Wide bandwidth and exceptional 1mV/DIV sensitivity make the Model 3500 a powerful diagnostic tool for engineers or technicians at a remarkable price. Delayed triggering allows any portion of a waveform to be isolated and expanded for closer inspection. Variable Holdoff allows stable viewing of complex waveforms.

- Exceptionally bright 5" CRT
- Delayed and single sweep modes
- Z axis intensity modulation
- X-Y operation • TV sync filter
- Fast 10ns rise time



DMM-200 **\$49.95**
3.5 DIGIT FULL FUNCTION DMM

Get highly accurate performance at a very affordable price. Rugged construction, 20 amp current capability and 22 ranges make it a perfect choice for serious field or bench work. Low battery indicator and tilt-stand. Probes and 2000 hour battery included.

- Basic DC accuracy: plus or minus 0.25%
- DC voltage: 200mv-1000V, 5 ranges
- AC voltage: 200mv-750V, 5 ranges
- Resistance: 200 ohms-20M ohms, 6 ranges
- AC/DC current: 200µA-20A, 6 ranges
- Input impedance: 10M ohm
- Fully overload protected
- Approx. 7" x 3 1/2" x 1 1/2" Wt. 11 ozs.

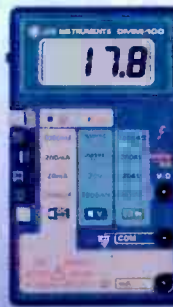

DMM-100 **\$29.95**
3.5 DIGIT POCKET SIZE DMM

Perfect for the field service technician. Shirt pocket size without compromising features or accuracy. Large, easy to read 1/2" LCD display. Fully overload protected for safety. 2000 hour battery life with standard 9v cell. Probes and battery included.

- Basic DC accuracy: plus minus 0.5%
- DC voltage: 2v-1000v, 4 ranges
- AC voltage: 200v-750v, 2 ranges
- Resistance: 2k ohms-2M ohms, 4 ranges
- DC current: 2mA 2A, 4 ranges
- Input impedance: 10M ohm
- Fully overload protected
- Approx. 5" x 3" x 1" Under 7 ozs.

CIRCLE 59 ON FREE INFORMATION CARD

COPYRIGHT 1987 JDR MICRODEVICES

JDR INSTRUMENTS, 110 KNOWLES DRIVE, LOS GATOS, CA 95030
RETAIL STORE: 1256 SOUTH BASCOM AVE, SAN JOSE, CA (408) 947-8881



ORDER TOLL FREE 800-538-5000



REASONS FOR SELECTING CIE

- Approved for educational benefits under the G.I. Bill for Veterans and other eligible persons.
- CIE provides printed job resumes, letters of recommendation, and lifetime Employment Service for all graduates at no extra charge.
- State-of-the-Art laboratory equipment is yours to keep and it comes assembled, ready for hands-on-experiments.
- Only CIE offers an Associate Degree program based on actual study time used. The faster you complete your degree, the less your overall tuition.
- Upon graduation, CIE offers you free preparation to pass the Certified Electronics Technician Exam.

CIE

CLEVELAND INSTITUTE OF ELECTRONICS 1776 East 17th Street • Cleveland Ohio 44114
PHONE TOLL FREE 1-800-321-2155 / In Ohio 1-800-523-9109

LEARNING... THE KEY TO SUCCESS

A CAREER IN ELECTRONICS STARTS WITH CIE.

For the last few years, the electronics field and related industries have been growing at an incredible pace. And today, a career in electronics offers more opportunities and greater rewards than ever before.

Just ask any of the many graduates of the Cleveland Institute of Electronics who have landed high-paying positions with aerospace, computer, medical and communications firms. They'll tell you success didn't come easy... but that CIE made it all worthwhile.

SPECIALIZED TRAINING CIE isn't just another be-everything-to-everybody correspondence school. We're accredited by the National Home Study Council. And with more than 1100 graduates each year, we're the largest independent home study school specializing *exclusively* in electronics. CIE has been training career-minded students like yourself for over 50 years and we know the business inside and out.

PRACTICAL TRAINING CIE students learn by doing, using sophisticated electronic learning tools that we've designed and developed. One such tool, our 4K RAM Microprocessor Training Laboratory, teaches programming, interfacing and lets you work with a broad range of computers in a way that working with a single, stock computer simply can't.

We combine that valuable hands-on training with our unique Auto Programmed® lessons, designed to teach you step-by-step and principle-by-principle. The result is practical training... the kind of experience you can put to work in the marketplace.

PERSONALIZED TRAINING While some of our students have a working knowledge of electronics others are just getting started. That's why we have 10 career course levels from Basic to Advanced. They let you start where you want. Learn at your own pace. And learn as much as you like. You can even earn an Associate in Applied Science Degree in Electronics. And when you need help, our trained professionals are on hand to assist you by phone or mail.

Learning electronics isn't easy, but getting started is. For a CIE catalog and enrollment information, just mail the coupon below. Or call toll-free 1-800-321-2155. In Ohio, call 1-800-523-9109.

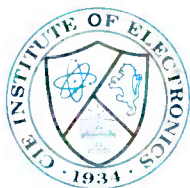

Accredited by the Accrediting Commission of the National Home Study Council, Washington, D.C.

CIRCLE 60 ON FREE INFORMATION CARD



YES! I want to get started. Send me my CIE school catalog including details about the Associate Degree program.

Print Name _____

Address _____ Apt. _____

City _____ State _____ Zip _____

Age _____ Area Code/Phone No. _____ / _____

Check box for G.I. Bulletin on Educational Benefits

Veteran Active Duty

MAIL TODAY!

CIE CLEVELAND INSTITUTE OF ELECTRONICS
1776 East 17th Street, Cleveland, Ohio 44114

ARE-86



Some courses feature the CIE Microprocessor Training Laboratory, an integral part of computers. You'll gain all the practical experience needed to work with state-of-the-art equipment of today and tomorrow.

LETTERS



DETAILS FROM DOLBY

We at Dolby Laboratories were gratified to see the article on surround sound in the April 1988 issue of *Radio-Electronics*. Overall, Mr. Hill did a commendable job of conveying the essence of the system's principles in simple and clear language. We also appreciated the inclusion of background information on the system's development history.

The article is sure to spark interest among your experimentally inclined readers to attach additional speakers to their systems to explore the power of matrixing techniques with encoded software. For that we are grateful, because once the multi-dimensional aspects of sound reproduction are experienced, one is generally hooked.

We would like to clarify some points raised in the article. Contrary to your statement, Dolby Laboratories does not own the rights to the surround-sound techniques. The work from the early 1970's to which you refer is that of Peter Scheiber, who holds the basic patents for matrixing audio signals. Dolby Laboratories is a sub-licensor of Mr. Scheiber's patents, though the specific circuits we license for manufacture are of our own design.

While the text of the article has it right, the "Which is Which?" sidebar is in error in its description of Dolby Surround decoder features. The original *Dolby Surround* logo signifies a structure as in your Fig. 3 of the article, which includes (among other elements not shown) the delay line, a low-pass filter, and a noise-reduction circuit. The newer *Pro Logic* logo signifies all of the above plus the use of an adaptive matrix stage to provide high-separation L, C, R, and S

(left, center, right, and surround) outputs. *Pro Logic* decoding—a direct descendent of the decoders we manufacture for *Dolby Stereo* cinemas—affords the highest degree of accuracy and flexibility in home-theater playback of surround-encoded materials.

The article stated that the delay line isn't really necessary. That is true only if the surround speakers are located about 10 feet farther away from the seating position than the front speakers, something not usually possible in a home system. While you alluded that speaker positions could be juggled to eliminate the delay requirement, you never recommended clearly how the desired delay effect could be obtained.

We would like to offer some constructive criticism regarding your decoder design. As it stands, the decoder offers the user virtually nothing more than the passive *Dynaquad* box of yesteryear, in which a third speaker was simply connected across the two outputs of the main stereo amplifier. Your active circuitry could have been easily improved at little cost by the inclusion of two features.

An input balance control would assure much better cancellation of center-channel signals when errors in channel balance exist. Since the matrix separation depends solely on the ability to cancel common-mode signals in a differential amplifier, it is essential that the monaural signal components have identical amplitude (and phase as you rightly noted) characteristics in both channels. (Note that an error of just 2 dB between the two incoming channels will limit center-to-surround separation to only 12 dB.) That is especially significant in your design

because there is no delay line to prevent leakage signals from being perceived ahead of the front signals. A linear potentiometer with a grounded wiper and four resistors (two placed in series with the potentiometer to limit the range to about 6 dB) would do nicely.

The other feature we would suggest to make the decoder more user-friendly would be a master volume control. Once someone goes through the trouble of balancing the front-to-rear levels with the various volume controls (possibly with the aid of the test tape you offer), he would like it to remain balanced when making overall level changes. Since your decoder has no level-sensitive circuitry, a common dual-ganged volume control placed right at the input could do the job of controlling the left, right, and surround output signals together. If op-amp noise or control attenuation mistaking are of concern (as that affects L-R separation), you could opt for a three-ganged output-level control as is used in typical *Dolby Surround* decoders.

ROGER DRESSLER
Dolby Laboratories Licensing Corp.
San Francisco, CA

FEEDBACK FROM FOSGATE

The article, "Build this Surround Sound Decoder" in the April issue is seriously flawed by mis-information. We don't begrudge any do-it-yourself project; we've built quite a few ourselves. Unfortunately, the project that you have presented is going to produce marginal performance at best. When used with less-than-perfect software, the processor described in your article will not allow performance remotely comparable to

even basic consumer *Dolby Surround* processors. Under such circumstances the obvious result will be a less-than-satisfied user.

The description and background information are incorrect. The term "steering logic" is more often used to describe high-separation designs such as the Fosgate *DSM* series or the Shure *HTS* series. The circuitry involves much more than just simple gain riding.

Second, the *Dolby Surround* logo is applied to any Dolby-licensed surround product that incorporates the processing, including a modified Dolby B-type noise reduction circuit as shown in Fig. 3 of the article. The *Dolby Pro-Logic* logo is applied only to Dolby-licensed products that use the logic circuitry developed and licensed by Dolby Laboratories. The Fosgate *DSM* series and the Shure *HTS* series are logic processors with independently developed circuitry. While those designs carry the standard *Dolby Surround* logo, their logic circuitry allows them to outperform standard non-

MOVIE TIME

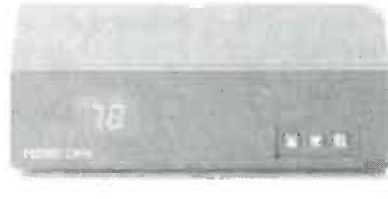

1-800-843-9845
1-305-652-1981

V-7800

V-7200

72 Channels
Remote Fine Tuning
Fine Tune Centering
2/3 Switchable

Favorite Channel Memory
Last Channel Recall
HRC/Standard Switch
90 Minute Sleep Timer 79.95

V-7800

Parental Control
Favorite Channel Memory
Remote Fine Tuning

10dB Amplifier
78 Channels
HRC/Standard Switch 89.95

SPECIAL PRICED CONVERTERS

Jerrold JRX- or JSX-3
Wired Remote Push Button
36 Channel Fine Tuning 39.95

Hamlin MCC-4000-2 or
Wired Remote Slide Control
42 Channel Fine Tuning 34.95

COUPON

NAME	ADDRESS		
CITY	STATE	ZIP	
TELEPHONE 1:	Exp. Dt.		
COD <input type="checkbox"/>	CHARGE <input type="checkbox"/>	CHECK <input type="checkbox"/>	SIG <input type="checkbox"/>
ACCT. #			
QTY.	ITEM	PRICE	TOTAL
Send to:	Shipping 5.50		
MOVIE TIME	CHECK ONE	FL 6% Sales Tax	
20203 NE 15 Ct.	AMEX <input type="checkbox"/>	MC <input type="checkbox"/>	VISA <input type="checkbox"/>
Miami, FL 33179	TOTAL		

30 DAY MONEY BACK GUARANTEE

CIRCLE 201 ON FREE INFORMATION CARD

PACESETTER PRODUCTIVITY

100 MHz TEK 2246A/2245A

Smart scopes, perfect setup! Tek sets the new, fast pace
\$1795/\$2395 for frequent measurements with automatic front panel
setup. Nonvolatile memory for up to 20 front-panel
setups (2246A). Time and voltage cursors. Exclusive SmartCursors™ track waveform
changes for voltage measurements. All backed by Tek's 3-year warranty.

NEW



Call Tek direct
for PaceSetter specs!
1-800-426-2200

Prices subject to change without notice.

Copyright ©1988, Tektronix, Inc. All rights reserved. TTA 906-A

Tektronix
COMMITTED TO EXCELLENCE

CIRCLE 188 ON FREE INFORMATION CARD

logic designs. The time delay can be variable from 15 to 30 milliseconds or fixed at 20 milliseconds if desired. The time delay is required for both standard *Dolby Surround* products as well as *Pro-Logic* products.

The author's description of the differences between the two processes incorrectly implies that his project is a replication of a basic *Dolby Surround* processor.

There are additional errors. The 7-kHz filter was incorporated in

Dolby theater processors long before the first licensed home product appeared. It was a requirement deemed necessary to reduce sibilant leakage and crosstalk. Such crosstalk can be introduced by poor film prints and optical-stereo pickups in theater projection systems.

Dolby Laboratories does not "own" the rights to the surround-sound technique. Peter Scheiber (a co-developer, along with Jim Fosgate, of the proprietary logic

technology incorporated in Fosgate products) holds all of the important patents in the area of matrix-surround encode/decode technology.

Scheiber has licensed Dolby Laboratories to encode MP Matrix and sublicense the manufacturing of Dolby-Surround processors to Dolby licensees.

Technically, the decoder is seriously flawed by the omission of an input-balance control. Left/right channel amplitude errors are common on home-video software on both Hi-Fi VCR and video-laser disc formats.

Unfortunately, your article, while well intended, will only serve to generate confusion about surround sound.

CHARLES WOOD

Fosgate, Inc.

Heber City, UT

Let POMONA hand you the very best quality.

Oscilloscopes can cost up to \$10,000 or more, while its interconnecting test accessories amount to a minor purchase. So it just doesn't make good sense to buy cut-rate imitations that could put your test results in jeopardy. Since you want accurate readings, insist on the most reliable test products: POMONA.



For your FREE 1988 General Catalog, circle reader service number printed below

POMONA
ITT Pomona Electronics

THE AUTHOR ANSWERS

I must defend my manuscript, "Understanding Surround Sound," against all who would label it incompetent. My manuscript fully explained surround sound without errors. I regret that the edited version didn't.

Very important were the half-angle formulas and their application to three channels, from Patent #3,746,792 (Scheiber, July 1973), as shown in Fig. 1.

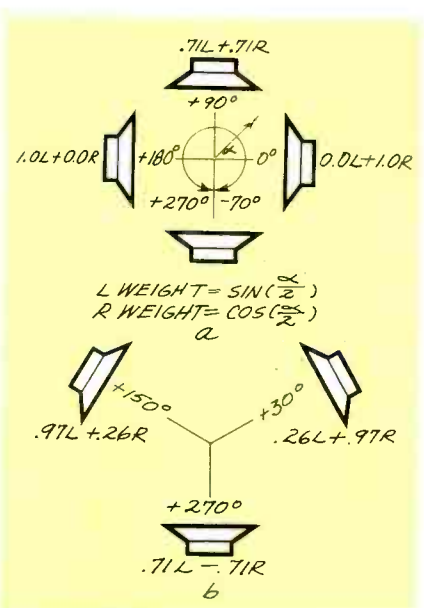

FIG. 1

Radio-Electronics failed to convey the importance of putting the

good seats in the circle's center, which keeps channel leakage from being noticeable. And there were other errors too obvious to discuss.

Mr. Wood and I agree that the explanatory errors are unacceptable. However, he claims that the lack of a balance control is unacceptable (one is available on the pre-amp), and condemns my design as one not even "remotely comparable" to basic Dolby decoders.

On the contrary, Mr. Wood.

I can accept gain control in a theater—but at home, on my audiophile sound system, your 7-kHz filter, noise reduction, time delay, and gain control sounds BAD. Once adjusted with my test tape, my three-channel approach produces a delightfully clean, crisp, and open quality of surround that blows away your AM radio-grade rear-channel in head-on comparisons. It's especially superior when listening to music.—Norman M. Hill, BSEE

continued on page 40

Crystek Crystals

FOR OPTIMUM STABILITY
AND RELIABILITY IN
FREQUENCY MANAGEMENT

QUARTZ CRYSTALS

FOR

Industrial Equipment/Instrumentation

- Micro-processor control
- Computers/Modems
- Test/Measurement
- Medical



General Communications

- Channel element Service (VHF/UHF)
- Land Mobile 2-way
- Marine
- Aircraft
- Telemetry
- Monitors/Scanners/Pagers



Amateurs/2-Meter/General Coverage CB/Hobblist/Experimenter

NEW

The Pulse of Dependable Communications

Crystek Crystals offers their new 16 page FREE catalog of crystals and oscillators. Offering state of the art crystal components manufactured by the latest automated technology. Custom designed or "off the shelf," Crystek meets the need, worldwide. Write or call today!

CRYTEK CORPORATION

DIVISION OF WHITEHALL CORPORATION

2351/2371 Crystal Drive • Ft. Myers, FL 33907

P.O. Box 06135 • Ft. Myers, FL 33906-6135

TOLL FREE 1-800-237-3061

PH 813-936-2109/TWX 510-951-7448/FAX 813-939-4226

TOLL FREE IN THE U.S.A. EXCEPT FLORIDA, ALASKA, HAWAII

CIRCLE 197 ON FREE INFORMATION CARD

PACESETTER PERFORMANCE

100 MHz TEK 2236/2235

100 MHz scope, counter, timer, DMM—just \$2795

The ultra-versatile Tek 2236 makes measuring everything from frequency, period and width to delay time and Δ time push-button easy—addition to CRT display, you get digital readout display accurate to 0.001% and beyond. PaceSetter performance on a modest budget? Look at the 100 MHz, dual-trace Tek 2235 with the best of the basics—just \$1575!



Call Tek direct
for PaceSetter specs!

1-800-426-2200

Prices subject to change without notice.

Copyright ©1988, Tektronix, Inc. All rights reserved. TT-906-B

Tektronix
COMMITTED TO EXCELLENCE

CIRCLE 189 ON FREE INFORMATION CARD

EQUIPMENT REPORTS

A. W. Sperry VH-600 Voltage Detector

Find out if an electric wire is live or dead, without a direct connection.



CIRCLE 49 ON FREE INFORMATION CARD

YEARS AGO, ALMOST EVERY TECHNICIAN used the magic of *phantom coupling* to determine if an audio amplifier having a high input impedance was working. The technician simply put his (or her) finger on the amplifier's input terminal and hoped a loud 60-Hz hum would rattle the speaker—indicating that the amp was working. Today, that very same phantom coupling is used by an inexpensive (suggested list price \$34.95) contact-less voltage detector, called a "Volt-Hound" VH-600 (A. W. Sperry Instruments, Inc., 245 Marcus Blvd., Hauppauge, NY 11787), to tell if an electric wire is live or dead. Despite its low price, the "Volt-Hound" really works.

Phantom coupling

The nature of phantom coupling is subject to some debate. One theory is that it is actually capacitive coupling to the local AC electric powerline. That theory works like this: No matter how infinitesimal, there always is some capacitive coupling between a person and nearby electric wires, and between the person and ground. A very tiny, almost unmeasurable, electrical current flows between the electric wire, the person, and ground; hence, there is an electric voltage (or current) in the person's body. If the person touches the input to a high-impedance amplifier—which is voltage, not current sensitive—

part of the voltage in the person's body is applied to the amplifier's input. As far as the amplifier is concerned, it is receiving a 60-Hz signal input, which is reproduced in the speaker.

Usually, hum can not be induced into a low-impedance amplifier input because the low impedance literally "loads down" the body, sharply reducing the voltage developed through that type of capacitive coupling.

Another explanation of phantom coupling claims that the magnetic field created by AC current flowing in a conductor induces an AC voltage in nearby objects, such as a service technician. However, that theory does not explain how voltage or current is induced in a body when no current is flowing through the conductor, because without current there is no magnetic field. The capacitive-coupling theory is, therefore, more viable.

The Volt-Hound

The principle of capacitive coupling is used by the Volt-Hound to test electric wires to determine if they're live or dead. As shown in the photo, all that's needed to conduct the test is to place the unit near the wire. If the wire is live—connected to the powerline—the Volt-Hound will beep and flash a light, even if there is no current flowing in the wire. If the wire is actually dead—meaning there is no connection to the powerline—there is no sound or light indication.

How it works

The Volt-Hound's block diagram is shown in Fig. 1. Note that there is a metal sensing tip, an Amplifier with a SENSITIVITY (gain) control, a Regulator that both amplifies and provides a constant output level,

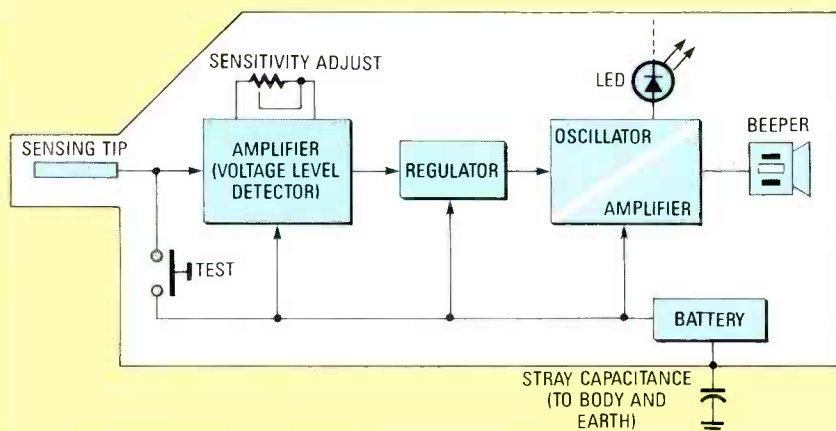

FIG. 1—THE BLOCK DIAGRAM OF A VOLT-HOUND. The TEST switch only checks the battery, not the sensitivity of the device. The Regulator is the circuit stabilizes the input signal to produce a constant output for the Oscillator/Amplifier.

and an Audio-Oscillator/Amplifier that produces a pulsing signal that eventually feeds the Beeper and the LED. A TEST switch feeds battery voltage to the amplifier input, which produces a beep and light if the battery is working. (The test switch checks only the battery; not the circuit operation.)

Figure 2 shows how the device works. When the Volt-Hound's detector—which is actually a metal plate—is positioned near a conductor that is carrying voltage, there is an effective capacitance between the conductor and the detector, and an effective capacitance between the detector and ground. Actually, the capacitance to ground is the capacitance from the detector to the user's hand, and the stray capacitance from the user to ground.

Notice that the effective capacitances form a capacitive voltage divider between the conductor and ground; hence, there is a minute AC voltage between the detector and ground. Since, as shown in Fig. 2, the detector is connected to

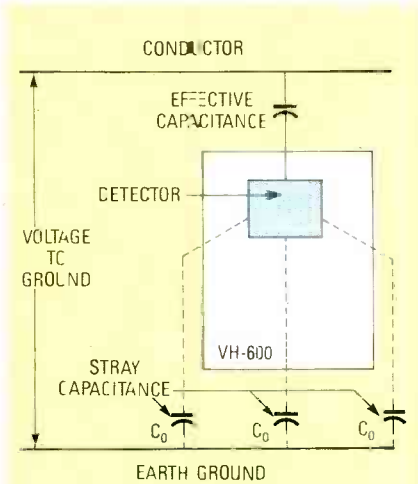

FIG. 2—THE AC SIGNAL IS COUPLED from the conductor to the device by effective capacitance, and from the device to ground by electrostatic capacitance—what is usually called “stray capacitance.”

the input of the amplifier, the “detected” AC voltage causes the test instrument to beep and light.

As you might expect, there can be a considerable variation in the stray capacitance to ground depending on whether the user is wearing rubber- or leather-soled

shows, standing on wood or concrete, etc. That is the reason for the SENSITIVITY adjustment. In typical use, the user would position the test device near a known live electric conductor and adjust the SENSITIVITY control until there was just enough gain to produce a dependable audio and visual indication of live wires. Then the device would be positioned near wires to be tested. (Both the SENSITIVITY control and the two LR-44 button-type batteries that power the device are accessed by simply pulling the rear cover off.

While the phantom-coupling effect could probably be used to test for AC voltage of any reasonable value and frequency, the Volt-Hound is specifically designed for a 50/60-Hz working-range of 100–600 volts. Take particular note of the 100 volt low-end limit. Although lack of the beep and light does indicate a dead wire, it can also indicate a wire carrying less than 100 volts, so use common sense and care even if a wire is indicated as dead. **R-E**

PACESETTER PRICE

50 MHz TEK 2210/2225

Best-of-class performance at

\$995/\$2195

Get the PaceSetter start in digital storage with Tek's NEW 50 MHz 2210. Featuring 20 MS/s per channel digitizing, 4K record length per channel plus familiar, full-bandwidth analog operation for just \$2195. And for pure and simple analog performance with unmatched economy look at the popular, 2-channel Tek 2225—just \$995!

NEW 2210
20 MS/s per channel

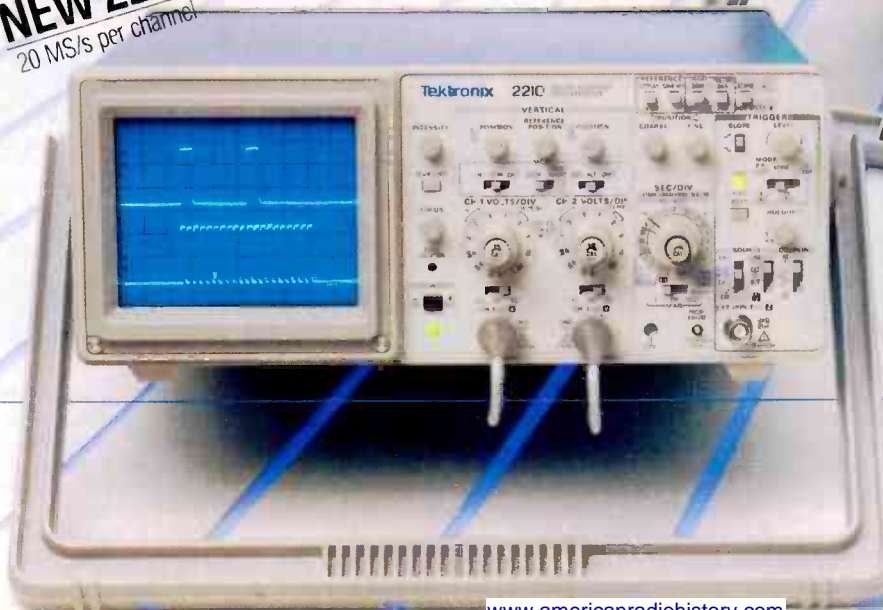

Call Tek direct
for PaceSetter specs!
1-800-426-2200

Prices subject to change without notice.
Copyright ©1988, Tektronix, Inc. All rights reserved. TTA 906-C

Tektronix
COMMITTED TO EXCELLENCE

CIRCLE 190 ON FREE INFORMATION CARD

Electronics Engineers & Designers!

Take any 3 books for only \$1.95 (Values to \$94.95)

SHARPEN YOUR SKILLS—With Quality, Affordable Professional Books

ELECTRONIC CIRCUITS

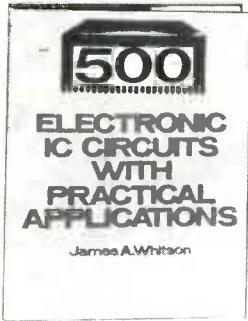

2920 Regular \$28.95
600 diagrams, schematics, and tables showing IC circuits. 352 pp.

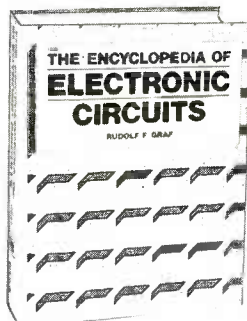

1938 Regular \$60.00
Over 1,300 useful and versatile electronic circuit designs. 768 pp. *Counts as two.*

STATE-OF-THE-ART



2657 Regular \$32.50
200 diagrams, schematics & tables—gives theory and practical design methods. 256 pp.



2931 Regular \$39.95
330 illustrations, a one-volume reference to satellite design and application. 448 pp. *Counts as two.*

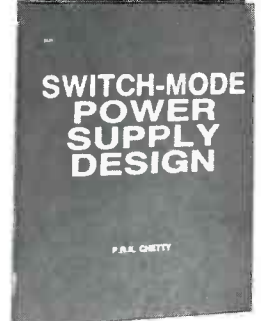

2631 Regular \$22.95
196 illustrations, a practical sourcebook complete with applications examples. 192 pp.

ELECTRONIC COMPONENTS

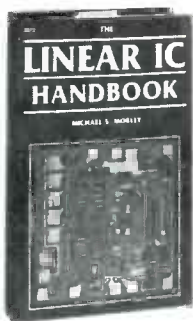

2672 Regular \$49.50
Linear integrated circuits—specifications, prices & data. 614 pp. *Counts as two.*



2957 Regular \$39.95
192 illustrations of electronic display devices. 416 pp. *Counts as two.*

COMPUTER SOFTWARE

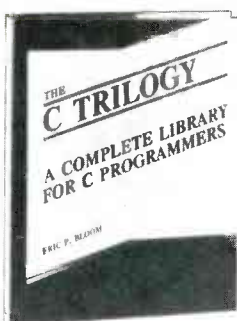

2890 Regular \$32.95
A 1-volume language primer, reference manual and subroutine function library. 588 pp. *Counts as two.*

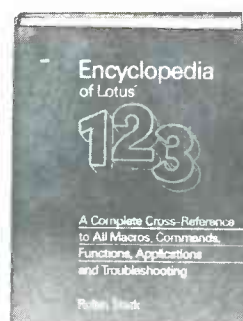

2891 Regular \$29.95
183 illustrations, a newly-published, reference guide. 496 pp.

REFERENCE

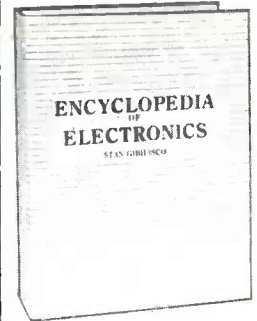

2000 Regular \$60.00
Over 1,300 diagrams, tables formulas and schematics. 3,000 key topics—Six pounds of electronics expertise! 1,024 pp. *Counts as two.*

COMMUNICATIONS



2888 Regular \$26.95
How computer networks work, how to make them work for you. 340 pp.



2864 Regular \$49.95
Stay competitive with R&D, Strategic Planning and Effective marketing. 734 pp. *Counts as two.*



9119 Regular \$35.00
Get the most out of your IBM PC or 50 other personal computers. 423 pp. *Counts as two.*

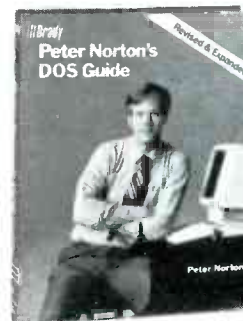

9083 Regular \$29.95
Make your IBM PC work for you with Norton's practical and informative guide. 362 pp.

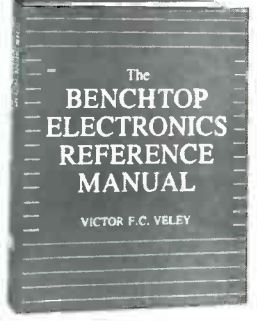

2785 Regular \$34.95
Easy-to-use reference to 160 electronic principles: ac/dc, solid-state, oscillators, amplifiers and radio communications. 620 pp. *Counts as two.*

ENGINEERING MATH

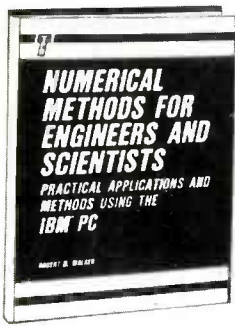

2697 Regular \$19.95
Ready-to-run math programs & subroutines for scientists and engineers. 304 pp.

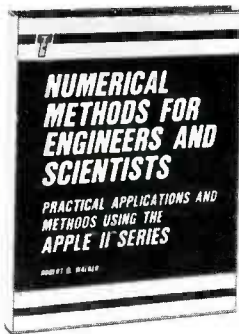

2647 Regular \$19.95
Ready-to-run math programs & subroutines for scientists and engineers. 296 pp.

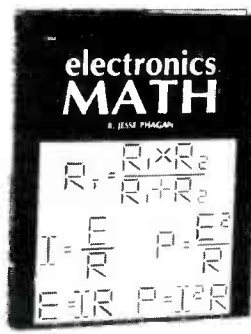

1962 Regular \$22.95
247 illustrations, a practical reference to basic electronics math usage. 256 pp.



2727 Regular \$24.95
Perform complex calculations with simple analog circuits. 200 pp.



2612 Regular \$25.95
102 illustrations, step-by-step methods for solving real-world partial and differential equations. 560 pp.

GENERAL SCIENCE

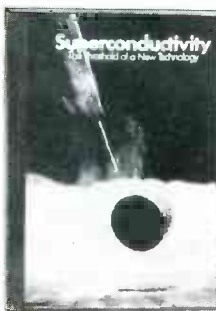

3022 Regular \$18.95
The impact of this new technology—the discoveries, the applications and the future. 66 illustrations. 160 pp.

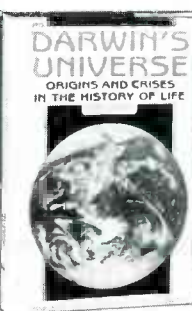

2773 Regular \$21.95
"I love everything Pelligrino writes."—Isaac Asimov. 238 pp.

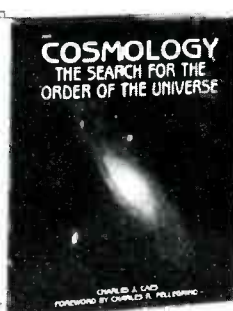

2626 Regular \$16.95
A fascinating book about man's oldest question—the search for understanding of cosmic order. 192 pp.

OTHER TITLES

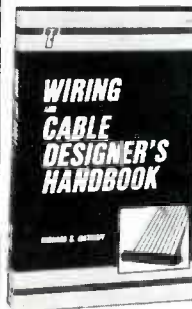

2720 Regular \$32.50
State-of-the-art design techniques and manufacturing methods. 250 illustrations. 304 pp.

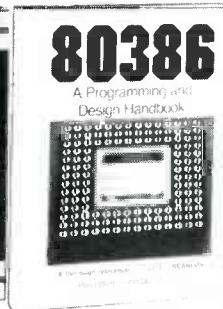

2937 Regular \$29.95
80386 architecture, assembly language programming as well as multi-tasking and multiprocessing. 150 illustrations. 448 pp.

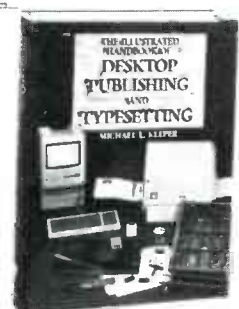

2700 Regular \$49.95
A sourcebook on computerized print and graphics. Profusely illustrated, 9" x 11" format. 770 pp. Counts as two.

How the Club Works

YOUR BENEFITS: You get 3 books for \$1.95 plus shipping & handling when you join. You keep on saving with discounts up to 50% as a member.

YOUR PROFESSIONAL BOOKSTORE BY MAIL: Every 3-4 weeks, you will receive the EE&D Book Club News describing the Main Selection and Alternates, as well as bonus offers and special sales, with hundreds of titles to choose from.

AUTOMATIC ORDER: If you want the Main selection, do nothing and it will be sent to you automatically. If you prefer another selection, or no selection at all, simply indicate your choice on the reply form provided. As a member, you agree to purchase at least 3 books within the next 24 months and may resign at any time thereafter.

BONUS BOOKS: Starting immediately you will be eligible for our Bonus Book Plan with savings of up to 80% off publishers' prices.

IRONCLAD NO-RISK GUARANTEE: If not satisfied with your books, return them within 10 days without obligation!

EXCEPTIONAL QUALITY: All books are quality publishers' editions especially selected by our Editorial Board.

All books are hardcover unless number is followed by a "P" for paperback. (Publishers' Prices shown)

SEND NO MONEY NOW!

INTRODUCTORY 10-DAY FREE EXAMINATION

ELECTRONICS ENGINEERS & DESIGNERS BOOK CLUB

Blue Ridge Summit, PA 17294-0860

YES! Please accept my membership in the *Electronics Engineers & Designers Book Club*® and send me the volumes I have listed below, billing me only \$1.95 plus shipping and handling charges. I understand that the books are sent on a 10-Day Free Examination basis. If dissatisfied in any way, I may return the books within 10 days and incur no further obligation. Otherwise, I agree to pay the enclosed invoice promptly and to receive regular club bulletins as described in "How the Club Works." To complete my membership obligation I need only purchase 3 additional books at regular members prices during the next 24 months, and may resign at any time thereafter.

(write 2 or 3 title numbers of your choice above)

NAME

ADDRESS

CITY STATE / ZIP

SIGNATURE

Valid for new members only. Foreign applicants will receive special ordering instructions. Canada must remit in U.S. funds. This order is subject to acceptance by the *Electronics Engineers & Designers Book Club*®.

DRE-688

ELECTRONICS ENGINEERS & DESIGNERS BOOK CLUB®

NEW PRODUCTS

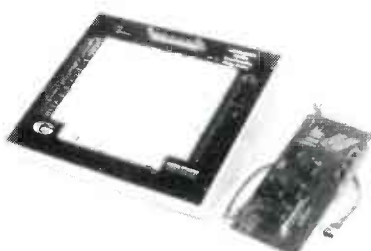

CIRCLE 10 ON FREE INFORMATION CARD

BREADBOARD. Global Specialties model *PB-88/4* offers everyone from PC hackers to professional designers a convenient way to prototype or experiment with IBM PC-compatible interfaces.

With a special buffered plug-in card and 60 conductor cable that connects right to any IBM-compatible PC, the model *PB-88/4* brings all PC bus signals to labelled solderless sockets, and provides more than 3300 breadboard contact points.

Power is supplied by the host computer and is switchable from the front panel, with LED "on" indicator. The breadboard area is 6" high x 13" wide x 11.5" deep.

The model *PB-88/4* is priced at \$299.95.—**Global Specialties**, 70 Fulton Terrace, PO Box 1942, New Haven, CT 06509.



CIRCLE 12 ON FREE INFORMATION CARD

GPIB SWITCHING MODULES.

John Fluke now offers the Philips *System 21*, providing test and measurement engineers with a family of low-cost, flexible GPIB/IEEE-488 switching modules.

System 21 is a modular-switching, digital I/O and measurement/control subsystem for small-to-medium size GPIB-based instrumentation systems. It is application-independent, allowing test-system designers and other engineers to develop modular, easy-to-configure systems for controlling multiple pieces of user-supplied test equipment.

Because *System 21* is based on a building-block concept, modules can be purchased on an as-needed

basis and reconfigured to accommodate future testing needs. It is composed of a master module and 13 independent slave modules for switching, digital I/O, measurement and control, and other user-defined functions. A single master module can support up to 50 different slave modules. Six different types of switching modules are available, including an 18 GHz switch, a low-level switch, a universal switch, and a 50-ohm coaxial switch.

System 21 is available with modules ranging in cost from \$450.00 to \$995.00, U.S. list price.—**John Fluke Mfg. Co., Inc.** P.O. Box C9090, Everest, WA 98206.

SOLAR ENERGY UNIS. Sunergy Inc., has introduced a line of solar battery chargers that use space-age technology to convert energy from the sun into electricity.

The heart of the *SunCharger* series is two 12" x 12" hinged photovoltaic solar-energy panels encased in a molded plastic carrying case that folds in half for compact storage.

Equipped with a handle for complete portability, the *SunCharger* is available in three different mod-

els; each is designed for outdoor use with a boat, truck, or van, or with entertainment equipment.

The "Marine SunCharger" comes equipped with a 20-foot charger cord and battery clamps that allow you to charge your boat's 9- or 12-volt battery without removing it from its housing.

The 12-volt "Van SunCharger" allows vehicle owners to trickle-charge their van or truck batteries; it comes equipped with a 1-foot charger cord.

The "Universal SunCharger" gives outdoor-entertainment buffs the option of playing their portable radio/cassette players, or TV sets, for hours on end in the sun without batteries.

The *SunCharger* family of products provide eight watts of power and up to 570 milliamps of current in the sun. The three units range from \$100-\$149 suggested retail prices.—**Sunergy, Inc.**, P.O. Box 177, Princeton, NJ 08542.

CHARACTER GENERATOR. From RCA comes the model *CGA030* character generator, which is designed to enhance the performance of Super VHS (S-VHS) and regular VHS video recorders and



CIRCLE 11 ON FREE INFORMATION CARD



CIRCLE 13 ON FREE INFORMATION CARD

camcorders with the addition of titles and special effects. With the model *CGA030*, camcorder users can place up to 60 characters on the screen at one time—in four different type sizes—and store frequently used words in a word register. The model *CGA030* also enables users to scroll titles and create effects such as curtain wipe and window wipe.

The model *CGA030* is priced at \$299.95—RCA Video Distributors, Deptford, NJ 08096.

SOLDERLESS BREADBOARDS.

Chenesco Products introduce their *X-tra Edge* line of solderless breadboards, which comes in four models of varying sizes.

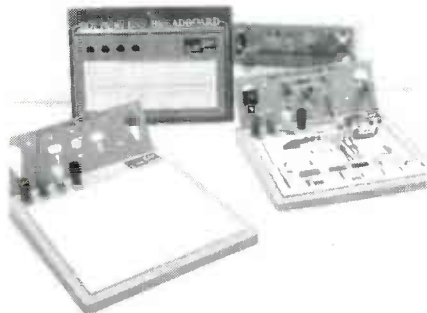

CIRCLE 14 ON FREE INFORMATION CARD

Each model is comprised of a solderless-breadboard area containing both distribution and terminal strips that accommodate all DIP sizes, lead components (0.3–0.8mm lead diameter), and 20- to 29-gauge (AWG) wire for interconnecting components. The breadboard contacts, spaced at 0.1" on center, are made of West-German made Stolberger Phosphor bronze, and are nickel-plated for reliability and low resistance. Initial-contact resistance is less than 3 milliohms at 1 kHz (20°C), and the contacts are rated for a minimum of 10,000 in-out insertions.

Four multi-purpose binding

posts that accept both standard banana jacks and lead wires are standard on each model, and are intended for connecting external power supplies easily.

The four models are as follows: Model *NB-112P* has 810 tie-points and 61 rows for DIP's; its size is 4.3 × 7.4 inches, and it is priced at \$16.95. Model *NB124P* has 1620 tie-points and 122 rows for DIP's; its size is 6.5 × 7.4 inches, and it is priced at \$34.95.

Model *NB-134P* has 2230 tie-points and 183 rows for DIP's; its size is 7.9 × 7.4 inches, and it is priced at \$49.95. Model *NB-145P* has 2940 tie-points and 244 rows of DIP's; its size is 9.7 × 7.4 inches, and it is priced at \$59.95.—Chenesco Products, Inc., 21 Maple Street, Centereach, NY 11720.

TV/VCR COMBINATION. From Goldstar Electronics comes the

Immediate Delivery

DMM's at SALE PRICES!

3 1/2 DIGIT 3200 COUNT ANALOG/DIGITAL MULTIMETERS

Model 73
Value Leader-World's Most Popular DMM-Autoranging
\$69 reg. \$79

Model 75
Autoranging + Range Hold Audible Continuity Function
\$105 reg. \$119

Model 77
Touch-Hold Feature + Features of Model 75
\$129 reg. \$149

Model 37
Bench/Portable, 0.1 VDC Accuracy 10 A. Range 2 yr. Warranty
\$219 reg. \$249

40th Year Anniversary Sale

Model 77 Model 8021B

3 YEAR WARRANTY

3 1/2 DIGIT HIGH-ACCURACY HAND HELD

Model 8021B
0.25% DC Accuracy, Audible Continuity Function
\$159 reg. \$179

Model 8020B
0.1% DC Accuracy, Audible Continuity & Conductance Function
\$189 reg. \$219

Model 8024B
0.1% DC Accuracy, 11 Functions Peak Hold, Temperature
\$225 reg. \$259

Model 8026B
0.1% DC Accuracy True RMS AC Volts & Current
\$199 reg. \$229

4 1/2 DIGIT TRUE RMS HAND HELD

Model 8060A
Measures True RMS AC Volts & Amps, dB + Frequency From 12 Hz to 200 KHz, Resistance to 300 M
\$325 reg. \$369

Model 8062A
Same as 8060A, but Less Frequency & dB
\$265 reg. \$299

TRUE RMS BENCH DMMs

Model 8010A
3 1/2 Digit 10 AMP Range
\$259 reg. \$299

Model 8010A-01
With Rechargeable Battery
\$299 reg. \$339

Model 8012A
3 1/2 Digit Two Low Ranges
\$349 reg. \$359

Model 8012A-01
With Rechargeable Battery
\$355 reg. \$399

Model 8050A
4 1/2 Digit Relative Ref. Function 0.03% DC Accuracy
\$355 reg. \$399

Model 8050A-01
With Rechargeable Battery
\$389 reg. \$439

Model 8060A
1 YEAR WARRANTY

Model 8010A
1 YEAR WARRANTY

Model 8012A
1 YEAR WARRANTY

FREE SHIPPING!
FREE SHIPPING TO UPS SHIPPABLE DESTINATION.

Send for FREE 480 page "Industrial Products Catalog". I understand it is FREE with any order or if requested on company letterhead. (Otherwise, \$4.95 to cover catalog and shipping costs.)

ORDER TOLL FREE
1-800-323-5925
IN ILLINOIS
312-297-4200

SINCE 1947
Joseph Electronics



JOSEPH ELECTRONICS, INC.
8830 N. Milwaukee Ave. Dept. R
Niles, IL 60648

Rush merchandise per attached order. I understand rated accounts are shipped open account; otherwise send per credit card.
 Visa Master Card Discover
 Check Money Order Rush Catalog
Card No. _____ Exp. Date _____

Name _____
Company _____
Street Address _____
City _____ State _____ Zip _____

IL Res. 7% Tax

The SC61 Waveform Analyzer™

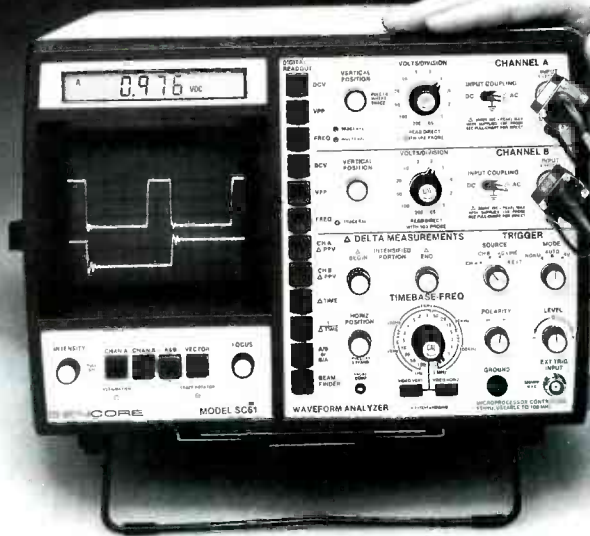

\$3,295 Patented

Here's what we say:

With just one probe hookup you can confidently analyze any waveform to 100 MHz, 10 times faster, 10 times more accurately, absolutely error-free — guaranteed or your money back.

Here's what our customers say:

"The SC61 gives the most information with a minimum of probe-swapping and knob turning."

Patrick Lyman
Biomedical Electronics
Los Angeles, CA

"In my use of the SC61 Waveform Analyzer, it has reduced the amount of time in half in fixing communications equipment."

Jeff Williams
Computer/Communications Repair
Madison, TN

"We have a small shop and need all the short cuts, time saving equipment we can get. Sencore passes with flying colors. Every tech should try their techniques with the SC61 Waveform Analyzer. Does what it should and more."

Bill Humble, Jr.
VCR, Audio and CB Repairs
Yulee, FL

**Discover What The SC61 Waveform Analyzer
Can Do For You! Call Today 1-800-843-3338.
In Canada Call 1-800-851-8866.**

100% American Made

SENCORE

3200 Sencore Drive, Sioux Falls, SD 57107 605-339-0100 In SD Only

CIRCLE 185 ON FREE INFORMATION CARD

"ViewMax," model KMV-9012, a combination VHS VCR and 19-inch color-TV set. It features an eight-event, 14-day programmable timer and quick-time recording up to eight hours, with standby quick-time recording to 24 hours. The unit has a 110-channel, cable-compatible electronic tuner and high-quality HQ picture-enhancement circuitry.



CIRCLE 15 ON FREE INFORMATION CARD

The "Viewmax" is loaded with additional features. Those features include auto power, play, rewind, eject, and off-functions, as well as record/play in three speeds. The unit's remote offers direct-access tuning, plus unified controls for volume, power, and VCR functions.

The "ViewMax" is priced at \$699.00.—**Goldstar Electronics International, Inc.**, 1050 Wall Street West, Lyndhurst, NJ 07071.

DRIVE HANDLE. From Cooper-Tools comes the Excelite *Quick Driver*, a new rotary drive handle for screw and nut drivers that is ergonomically designed to put additional torque into your work. The rotary driver features a bushing in the handle to allow it to reduce friction and spin freely.



CIRCLE 16 ON FREE INFORMATION CARD

The driver can be used with slotted and Phillips screwdrivers, nut drivers, and Allen hex drivers. In addition, the driver can be used with any *series-99* blade offered in the Excelite line.

The *Quick Driver* is priced at \$9.89.—**CooperTools**, P.O. Box 728, Apex, NC 27502.

LOW-BAND TRANSCEIVER. Midland introduces a compact, low-band portable transceiver, the model 70-043. It has a one-piece die-cast chassis and stainless steel front and back. RF output is 5 watts, tunable to 2 watts; it provides up to four crystal-controlled channels in the frequency range 30-50 MHz.



CIRCLE 17 ON FREE INFORMATION CARD

A twist-off 600-mAh battery pack is standard; with that battery, the unit is about 5 inches high by 2½ inches wide by 1½ inches deep and weighs approximately 22 ounces without the antenna. In addition, an optional 1000-mAh battery pack is also available. Other options for the unit include CTCSS, external speaker/microphone with a lapel clip, a backplate with belt clip, carrying cases, and battery chargers.

The model 70-043 is priced at less than \$425.—Midland LMR, 1690 N. Topping, Kansas City, MO 64120.

50-WATT SOLDERING IRON. M. M. Newman Corporation offers the Antex model XTC, a temperature-controlled 50-watt soldering iron designed for use with heat- and voltage-sensitive components requiring precise soldering temperatures.

The model XTC features a thermocouple in the tip, combined with a sliding potentiometer in the station, for precise temperature control with positive feedback. The tip is positively grounded and zero-crossing electronic switching

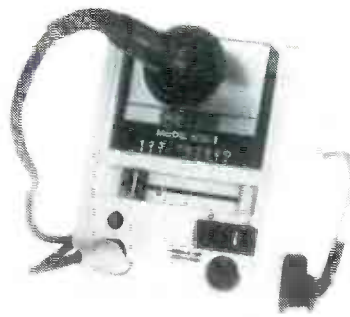

CIRCLE 18 ON FREE INFORMATION CARD

in the station eliminates the generation of RF interference and magnetic fields.

Providing temperature control from 140°F to 815°F, with ±2% accuracy, the model XTC heats up in 45 seconds and has quick recovery times, because the heating element is directly under the tip. Three sizes of slide-on iron-plated tips are offered: ⅜", ⅙", and ⅜". The iron has a 4-foot burn-resistant cord, with a stand built into the

SEEK PROFESSIONAL HELP Servicing electronic equipment isn't always easy, especially if you're doing it in the field. At Chemtronics we can help with over 200 specially engineered products for the maintenance, repair and production of high technology equipment. Call today for our latest problem solving catalog.

Chemtronics
Keeping pace with advanced technology.

Chemtronics Inc. 381 Old Willets Path Hauppauge, NY 11788 516-882-3322 Telex 968567

CIRCLE 54 ON FREE INFORMATION CARD

Macrovision ...

now you see it, now you don't.

Remove copy-protection from video cassettes.

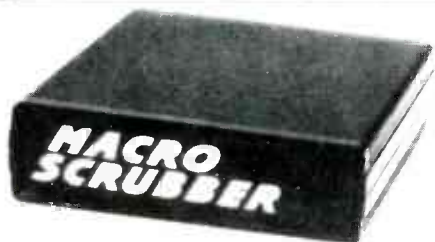

- Digital Filter Type, removes only Macrovision pulses
- No adjustments, crystal controlled
- Compatible with all VCR's, uses automatic vertical blanking level

Macro-Scrubber — We stock the exact parts, PC board, and AC adaptor for an article on Building a Macro-Scrubber appearing in *Radio-Electronics* December 1987 issue.

JMAK-1 Parts Package \$19.00

Includes all the original resistors, capacitors, diodes, transistors, integrated circuits, and crystal.

JMAK-2 PC Board \$9.95

Original etched and drilled silk-screened PC board used in article

JMAK-3 AC Adaptor \$7.95

Original (14 to 18 volt DC @ 285 ma) AC adaptor used in article.

Free reprint of article on building a Macro-Scrubber with any purchase above. Add \$2.50 shipping & handling; \$4.50 Canadian orders. Note: Unauthorized duplication of copyrighted material is illegal. Use Macro-Scrubber for viewing only.

72-CHANNEL

CABLE CONVERTER

WITH INFRA-RED REMOTE CONTROL



Add \$3.50 shipping & handling
\$9.50 Canadian orders.

MC-702 CONVERTER

\$79.95

- 72-channel capability
- Wireless, Infra-Red remote control
- Channel output 2 or 3 switchable
- Microprocessor controlled PLL operation
- Skip channel memory eliminates unused channels
- Parental control for all channels
- Last channel recall
- Fine tune memory
- UL listed/FCC approved
- Simple installation with any TV
- Includes battery and 3 foot coax cable

CABLEMASTER \$19.95

Cable/VCR Timer

- Record multiple premium play channels
 - Turns cable box on and off
 - Selects channel for unattended recording
 - Thousands sold nationally for \$99.95
- Add \$3.50 shipping & handling
\$4.50 Canadian orders

ORDER TOLL FREE ANYTIME

1-800-227-8529

Ask for **FREE Color Catalog**

Inside MA: 617-695-8699

VISA, MASTERCARD,
or C.O.D.



**J & W
ELECTRONICS, INC.**

P.O. BOX 800 • MANSFIELD, MA 02048

©Copyright 1988 by J&W Electronics Inc.

station for convenience.

The Antex model XTC 50-watt soldering iron and temperature-control station has a list price of \$167.70.—M. M. Newman Corporation, 24 Tioga Way, P.O. Box 615, Marblehead, MA 01945.

POWER SUPPLIES. OK Industries introduces a new series of bench-top laboratory power supplies—the PS732 series. Each model in the series has dual 3¼-digit display for simultaneous metering of current and voltage. Output controls provide 0.1% accuracy for voltage readings and 0.3% accuracy for current readings; the display provides resolution to 0.01 volt and 0.001 amp over the entire range of the unit.

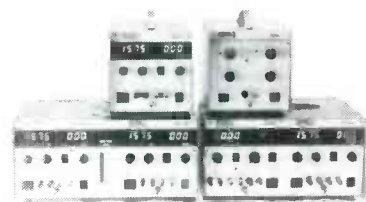

CIRCLE 19 ON FREE INFORMATION CARD

The PS732 series can be operated in constant-current or constant-voltage modes. The display provides a clear indication when the supply crosses over from constant voltage to constant current.

Specifications are as follows: The model PS732 is single output, range 0–30 volts/0–2 amps. The model PS732-Q is dual output/quad mode, range 2 × 0–30 volts/0–2 amps, 0–30 volts/0–4 amps, 0–60 volts/0–2 amps, or 0 ± 30 volts/ 2 amps. The model PS732-K is triple output, range 0–30 volts/0–2 amps, 0–30 volts/0–1 amp, and ± 5 volts/7 amps.

Prices for the PS732 series start at \$345.00.—OK Industries, Inc., 3455 Connor Street, Bronx, NY, 10475.

RADIO TELEGRAPH TERMINAL. ACE Communications introduces the model AR-501, a triple-mode radio-telegraph (CW) terminal for amateur-radio operators and shortwave listeners.

The model AR-501 performs as a CW decoder, CW trainer, and electronic keyer. Features include automatic speed follow-up and

CIRCLE 65 ON FREE INFORMATION CARD



CIRCLE 20 ON FREE INFORMATION CARD

threshold control, LED tuning indicator, 32-character LCD display, random code generator, and electronic keyer for both standard and iambic keying.

In all three modes, codes can be monitored by the internal speaker and printer through the parallel-printer port of the unit. The model AR-501 measures 4.5" x 6.25" x 2.25" and requires a 12-volt DC source. It is priced at \$299.00, including AC adapter and parts for hookup.—ACE Communications, Inc., 22511 Aspan Street, Lake Forest, CA 92630. R-E

Test VCR Mechanics Fast and Easy!

Take the guesswork and hassles out of VCR mechanical problem diagnosis!
Four Universal, Powerful Tools for VCR Service

Tape Tension Gauge: The Tentelometer® is the world's most universal method of measuring hold back tension. Calibration can easily be checked in the "field". Merely slide the probes over tape to measure tape tension directly in grams. Illustrated instruction manual included. This is the back tension gauge referenced by many of the VCR service manuals, and it will work on all VCRs.

T2-H7-UM \$325



Video Head Protrusion Gauge: Universal, fast, safe method of measuring the amount of video head tip wear. Measures in microns and ten-thousandths of an inch. Allows accurate predictions of remaining head life. Head wear provides useful information regarding VCR condition and wear on other components. Stop guessing about head wear. Accessory "S1" stand allows use on any VCR.

HPG-1 \$495 S1 \$95



Spindle/Elevator Gauge: The TSH gauge inserts into the VCR just like a cassette. The new TSH-V5 performs 6 critical measurements to eliminate tape binding and edge damage. This gauge quickly locates problems that can't even be detected by other methods. Fully illustrated instruction manual is included.

TSH-V5 for VHS: \$395

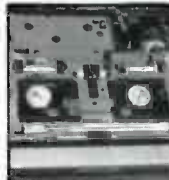

Torque Gauge: A universal, inexpensive, accurate torque gauge for VHS and Beta VCRs. Calibrated in Gram-Centimeters both clockwise and counterclockwise. Complete with easy-to-follow, detailed instruction manual for VHS recorders. Includes a modified VHS cassette for ease-of-use.

Complete System
TQ-600 \$139



Tentel® provides the most powerful, easy-to-use, field calibrateable, universal VCR test equipment available for various mechanical tests. Call our application engineers today for answers to your questions. Ask about the combination discount when ordering all 4 gauges.

Tentel Corp.

1506 Dell Avenue
Campbell, CA 95008

(800) 538-6894
(408) 379-1381
in California

CIRCLE 187 ON FREE INFORMATION CARD

WM. B. ALLEN SUPPLY COMPANY

ALLEN SQUARE

300 Block North Rampart Street

New Orleans Louisiana 70112



HITACHI
COMPACT SERIES

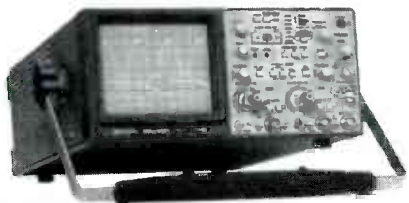

V-1065 DC to 100MHz
With Cursor Readout
\$1645
Save \$250!

V-1060 DC to 100MHz
\$1395
Save \$200!

V-665 DC to 60MHz
With Cursor Readout
\$1345
Save \$150!

V-660 DC to 60MHz
\$1045
Save \$150!

Probes Included FREE with all Hitachi scopes

Call for pricing & quantity discounts on replacement probes for all test equipment

CALL TOLL FREE
FOR GREATER SAVINGS!
ASK FOR
BOB LADNIER

DISCOUNTS UP TO \$400!

Dual Channel 6" CRT Scopes
V-425 DC to 40MHz, CRT
Readout
\$845. Save \$150!
V-423 DC to 40MHz, Single
Time Base Delayed Sweep
\$745. Save \$250!
V-422 DC to 40MHz, DC
Offset
\$795. Save \$130!
V-225 DC to 20MHz, CRT
Readout
\$720. Save \$75!
V-223 DC to 20MHz,
Delayed Sweep
\$695. Save \$100!
V-222 DC to 20MHz, DC
Offset
\$515. Save \$200!
V-212 DC to 20MHz
\$440. Save \$175!
Digital Storage Scope
V-6020 1MHz Sampling,
Dual Channels
\$1750. Save \$200!

Dual Channel
Mini-Portable Scopes
V-509 DC to 50MHz,
Delayed Sweep
\$1195. Save \$250!
V-209 DC to 20MHz
\$822. Save \$175!
Quad Channel Multi-
Function Scopes
V-1150 DC to 150MHz,
Delayed Sweep
\$2600. Save \$350!
V-1100AU DC to
100MHz, Delayed Sweep
\$2175. Save \$315!
NTSC Waveform Monitors
V-079 6" CRT
\$1625. Save \$125!
V-099 3.5" CRT
\$950. Save \$300!
NTSC Vector Scopes
V-069 6" CRT
\$1825. Save \$125!
V-089 3.5" CRT
\$1284. Save \$400!

928 pg Catalog FREE with your order

POLAROID® Instant Hard Copy Direct From Oscilloscopes



DS-34 CAMERA

- Pistol Grip For Ease of Operation
 - Works on Any Make of Oscilloscope
 - Three Full Year Warranty
- 5", 6" and 7" Hoods Available
Separately for \$51 each.



ONLY \$290.
Save \$135!

CIRCLE 103 ON FREE INFORMATION CARD

TOLL-FREE
800 535-9593
24HR FAX ORDER LINE 504 525-6361

LOUISIANA
800 462-9520
NEW ORLEANS
504 525-8222

STATE OF SOLID STATE

Linear IC's



ROBERT F. SCOTT,
SEMICONDUCTOR EDITOR

ONE OF THE MOST INTERESTING DEDICATED linear IC's I've recently come across is SGS Semiconductor Corp's TDA2320A stereo pre-amplifier, which is intended primarily for use in portable cassette players and high-quality audio systems. Note that the device carries an A suffix, and is not to be confused with SGS's TDA2320, a pre-amplifier designed for IR remote-control systems.

The device is essentially two

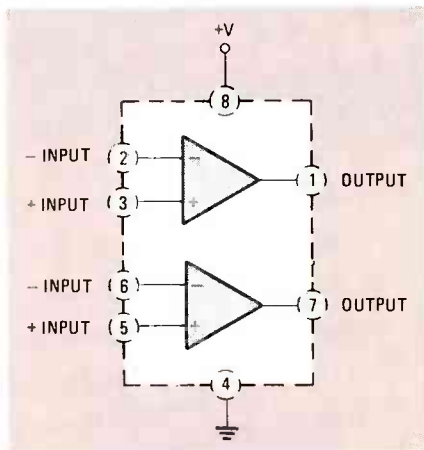

FIG. 1

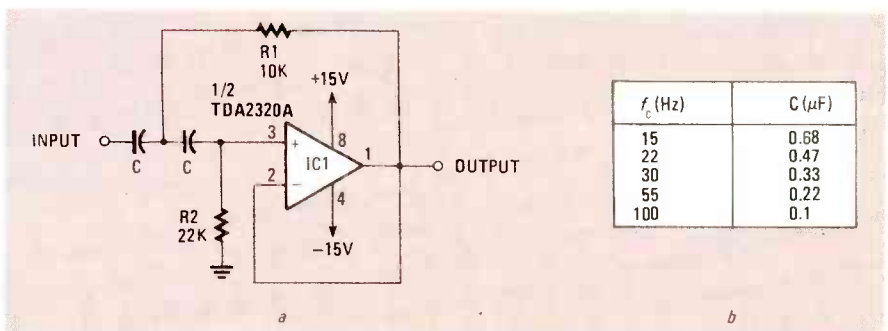

FIG. 3

high-grade audio op-amps in an 8-pin minidip package. It features very low distortion, no pop-noise, short-circuit protection, and can operate from 3-36-volt single or split (bipolar) power supplies. Current consumption is not specified when V_s is 3 volts, but it is a low 0.8 mA when V_s is 15 volts, and only 2 mA when V_s is 36 volts. The internal structure and pin connections are shown in Fig. 1.

The TDA2320A's data sheet includes a wealth of information and circuits covering a number of applications for instance, Fig. 2 shows is an active bandpass filter that can be used to drive the mid-

range amplifier of a tri-amped three-way speaker system consisting of a woofer, a tweeter, and a honker (mid range).

Another application is a subsonic filter that can be adapted to eliminate turntable rumble and tape-recorder flutter. That filter is shown in Fig. 3-a. The accompanying table, Fig. 3-b, specifies the value of capacitor C for five frequencies between 15 and 100 Hz.

Other applications include an electronic two-way crossover network, a high-cut filter, a three-band tone control and more. For data sheets and further information on the TDA2320A, write to **SGS Semiconductor Corp.**, 1000 E. Bell Rd., Phoenix, AZ 85022.

High-speed CMOS counter

A new programmable divide-by-N counter can divide an input frequency by values between 3 and 15,999. Called the CD54/74HC/HCT4059, the device is a presettable down-counter that produces an output pulse one clock-cycle wide at a rate equal to the input frequency divided by the preset value (N).

Two versions are available:

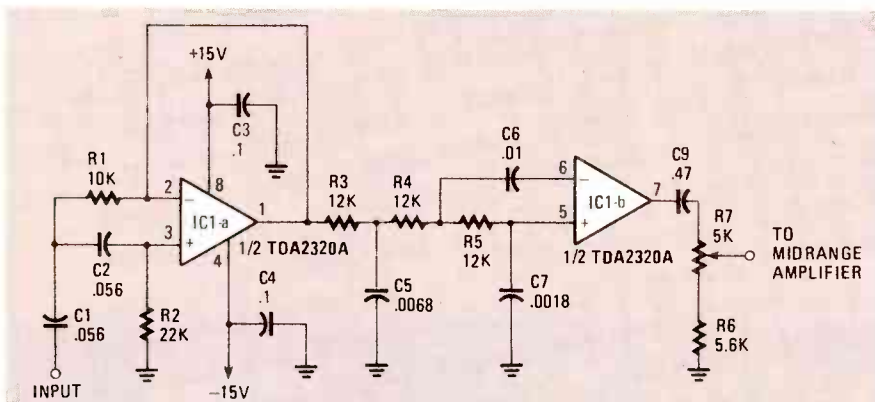

FIG. 2

CD54/74HC types for new all-CMOS logic designs; CD54/74HCT types that are pin, function, and performance-compatible with low-power Schottky TTL (LSTTL) bipolar logic.

Internally, CD54/74HC/HCT4059 counters contain five counting sections. The first and last sections are programmed by three mode-select inputs (κ_A , κ_B , κ_C) that set the modulus or divide-by-N number. The intermediate counting section consists of three cascaded divide-by-10 BCD counters. The divide-by number is programmed by presetting the proper logic levels on 16 jam inputs (J1 through J16).

The mode-select inputs control the first and last sections. For example, if the first section is set to divide-by-2, the last section can be set to divide-by-8. But, when the first section is set to divide-by-10, the last section cannot perform any divide-by operations. The first section can divide-by-10, -8, -5, -5, or -2 while the last section can divide-by-1, -2, -4, or -8.

The counters can be programmed to a "master preset" state by holding the κ_B and κ_C lines low. The internal counters are preset with the jam inputs and hold the levels as long as the κ_B and κ_C lines are held low. Counting starts when any state other than the master preset is selected. A LATCH-ENABLE input can be used to hold the output high after the occurrence of an output pulse. If the LE (latch-enable) terminal is low, the output pulse remains high for only a single clock-cycle.

HC types operate up to 54 MHz; HCT types operate up to 50 MHz. The CD54HC/74HC types have a supply-voltage range of 2-6 volts DC, while the CD54/74HCT operate from 4.5-5.5 volts DC.

The CD54HC/HCT4059 counters are in 24-pin ceramic DIP packages and carry the F suffix. CD74HC/HCT devices are offered in three 24-pin DIP packages; a narrow-body package (EN suffix), wide body (E suffix), and surface-mount (M suffix). When purchased in 100-piece lots, the counters are priced at \$6.77 each.

For further information and a copy of data sheet File No. 1853, write to GE/RCA Solid State, PO Box 2900, Somerville, NJ 08876.

New motor driver

The new Sprague UDN-2943Z is a half-bridge motor driver with extensive protection circuitry. The 24-volt, 1-amp bipolar IC drives DC servo motors and can be paired for full-bridge applications, or tripled for three-phase brushless DC motors.

On-chip safeguards include thermal shutdown, over-voltage shutdown, crossover-current protection, short-circuit protection (when the source driver is shorted to ground), input logic lockout (prevents both source and sink drivers from turning on simultaneously), and transient suppression. The driver operates with pulse-width modulation—either source or sink chopping, and has saturated outputs with very low power consumption.

The new device is in a modified 5-lead power-tab TO-220 plastic package. Price is \$1.35 each in 100-piece lots. Detailed technical information is in Data Sheet 29318.4 from Technical Literature Service, Sprague Electric Co., PO Box 9102, Mansfield, MA 02048-9102. R-E

Scan and record temperatures from freezing to scorching.



The new Fluke 52 goes to great extremes to outperform any other handheld thermometer.

At the touch of a button, it sequentially scans the readouts of two temperature inputs and their difference. Or records the minimum and maximum from any one of these three channels for up to 1,200 hours.

You can measure extreme temperatures with 1/10th of a degree resolution, using standard K or J type thermocouples probes.

Prices for the Fluke 50 Series are surprisingly low...starting at just \$129 for the single-input Fluke 51. Order yours today.

For the name of your local supplier and a free brochure call toll-free 1-800-44-FLUKE, ext. 33.

FROM THE WORLD LEADER IN HANDHELD TEST INSTRUMENTS.

FLUKE 51/52 THERMOMETERS

Measurement range:	
K-type:	-200°C to +1370°C (-328°F to +2498°F)
J-type:	-200°C to +760°C (-328°F to +1400°F)
Accuracy:	
K-type is	±(0.1% of reading + 0.7°C or 1.3°F)
J-type is	±(0.1% of reading + 0.8°C or 1.4°F)
°C or °F Selectable • Hold Mode	
Scan, Differential, and Mini/Max Recording Modes (52 only)	
Standard mini-connector input	
1200 hour 9V battery life • 3-year warranty	
General-purpose K-type bead probe included (two with 52)	

Rely on JAN for 3-WAY Help

- TECHNICALLY CORRECT**
Crystals to Your Specs
- QUICK TURNAROUND**
with huge inventory, prompt service and Emergency Order Plan
- LOW PRICES**

QUARTZ CRYSTALS FOR

Two-Way — Industry — Marine
Amateurs — CB — Microprocessor
Scanners



Since 1965

For Free Catalog
Call or Write

JAN CRYSTALS
P.O. Box 06017
Ft. Myers, FL 33906
(813) 936-2397



CALL 1-800-237-3063
FREE (Except Florida)

CIRCLE 104 ON FREE INFORMATION CARD



© 1986 Fluke, Ad No. 1272-F50

CIRCLE 121 ON FREE INFORMATION CARD

INTRODUCING THE AR-100 MAXI-PROBE™

The World's First Pen-Style DMM
with Built-In 10MHz Logic Probe

INNOVATION, NOT IMITATION

The AR-100 Maxi-Probe. Unheard-of features and performance in one small package. Volts, Ohms, Audible continuity, Data Hold. Then add a full-function, TTL/CMOS logic probe. Screw-on accessory tips. Diode Test. Test Leads. And a storage case.

Result: All the functions you need for both analog and digital testing in one small package, at one Low price.

So visit your local ARI distributor and hold of the future, today. The AR-100 Maxi-Probe. All others pale by comparison.

Measure:

- Volts •Ohms •Diodes
- Audible Continuity

And:

TTL & CMOS Logic To 10MHz!

Features:

- Screw-On Accessory Tips
- Data Hold



AMERICAN RELIANCE INC.
VALUE BEYOND MEASURE

9241 E. VALLEY BLVD. ROSEMEAD, CA 91770
(800)654-9838

ARI manufactures a complete line of electronic test equipment, including EPROM, EEPROM, and PLD programmers, IC testers, Cable testers, DPMs, DMMs, and Logic testing devices. Call or write today for your free Brochure.

CIRCLE 183 ON FREE INFORMATION CARD

LETTERS

continued from page 24

THE EDITOR EXPOUNDS

We regret the errors in explanation that were printed in Mr. Hill's article. We should have stressed more the importance of proper speaker placement. And we apologize to Dolby for mixing up the details of what their logos represent.

We are, however, very pleased with the project we described. All those who had the opportunity to hear the decoder were most impressed—especially when they learned that the decoder could be built for about \$20. They did not hear performance that was "marginal at best."

While we're on the subject of the decoder, we should note a change in suppliers for the calibration tape: The new supplier is Sound Solutions, 1535 145th Place S.E., Suite J-17, Bellevue, WA 98007. Only Hi-Fi (not linear) stereo tapes are available.—Editor

NEW RUGGEDIZED SCOPE PROBES

Just a phone call away.

\$35 P6103

50 MHz 10x
Compensation Range
15 to 35 pF

\$58 P6109

150 MHz 10x
Compensation Range
18 to 22 pF

These new passive voltage probes can be used with any oscilloscopes having matching compensation ranges. Screw in tips mean easy repair, no downtime.

To order call toll free **1-800-426-2200**

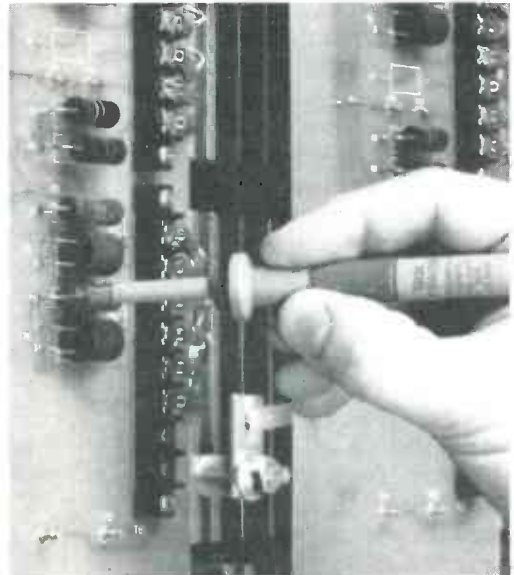

Tektronix®
COMMITTED TO EXCELLENCE

Copyright ©1988, Tektronix, Inc. All rights reserved. KBA-810-1

CIRCLE 194 ON FREE INFORMATION CARD

BUILD THIS

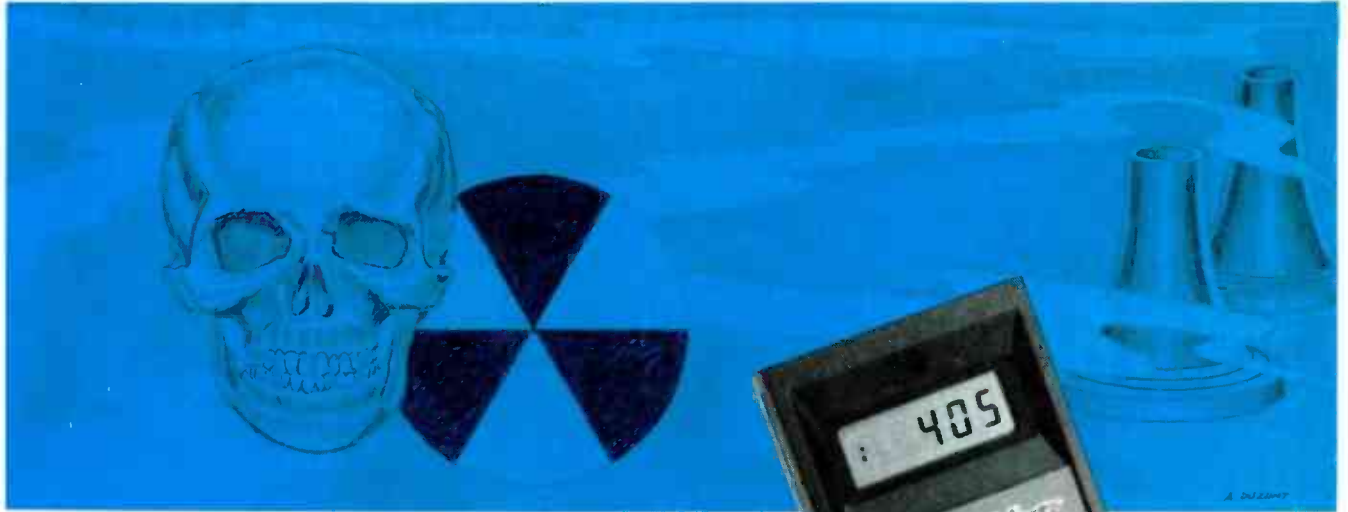

RADIATION MONITOR

This hand-sized Geiger counter is so sensitive it can measure the radiation from a ceramic drinking cup.

JOE JAFFE, DAN SYTHE, AND STEVE WEISS

HAVE YOU EVER DRIVEN PAST A NUCLEAR power generating plant and wondered whether it was leaking radiation? Is there radioactive radon in your basement? When the Chernobyl nuclear plant exploded in April, 1986, and the Three Mile Island plant almost had a meltdown in March, 1979, did you wonder if any of the radiation was coming your way? If you have a luminous watch dial that glows in the dark, is it giving off radiation? Did you know that common items found in a home emit small amounts of ionizing radiation?

Construct your own Geiger counter and you will find the answers to those questions and many more. With a Geiger counter you can reassure yourself that radiation levels in your area are normal. You can detect nuclear-plant radiation leaks by monitoring changes in radiation level, and even sound an alert if the level is abnor-

mally high. You can network with your friends who have similar instruments to determine radiation patterns. You can identify items in your home that are radioactive. And you can explore for underground deposits of radioactive materials. In short, if you build a Geiger counter you will learn

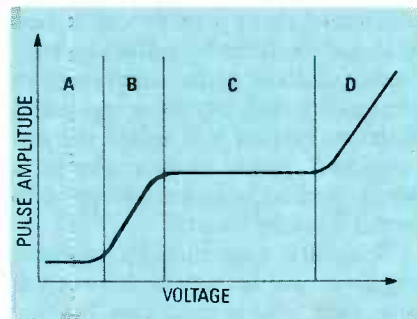

FIG. 1—THE RELATIONSHIP BETWEEN PULSE AMPLITUDE and the electrode voltage of a Geiger tube. Region c, which is the most sensitive to radiation, is called the Geiger region.

about radiation, where it comes from, and how it is detected.

Measuring radiation

A common characteristic of alpha, beta, gamma, and X-rays is that they ionize the material that they strike or pass through. Therefore, it is possible to measure the amount of radiation by measuring the resulting degree of ionization. One of the first devices used to detect ionization was the electroscope, developed about 100 years ago. In that device, when a gold leaf and its metallic support are insulated from another metallic member and charged to a DC potential of several hundred volts, the gold leaf is repelled. With high-quality insulation, the charge leaks off slowly, but if any ionizing radiation is present the charge leaks off more quickly. Obviously, only relative-intensity measurements are possible.



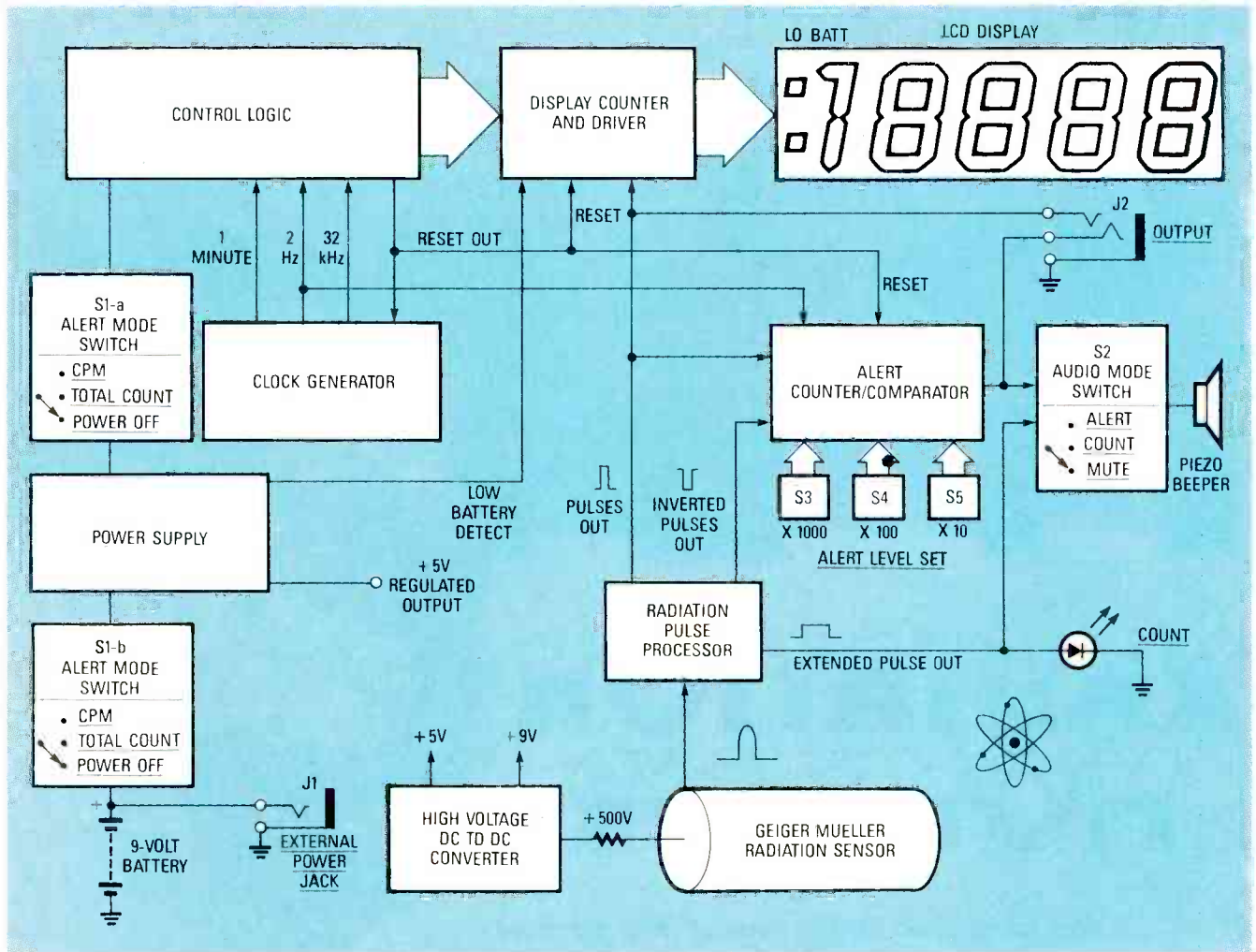

FIG. 2—BLOCK DIAGRAM OF THE RADALERT. The Alert Counter/Comparator can be programmed to sound a beeper when the pulse count exceeds a user-determined value.

The most common sensor used today to detect ionization is the Geiger tube, which consists of an enclosed anode and cathode separated by a mixture of argon, neon, and either chlorine or bromine gases. Usually, the cathode is a thin-wall metallic cylinder sealed at each end with an insulating disk so that the gas is contained. The anode is an axial wire in the cylinder that extends through an insulator. A DC voltage connected to the electrodes creates an electric field within the chamber. A pulse of current is generated when radiation passes through the container and ionizes the gas. The pulses are counted and electronically processed for display in a variety of ways. The relationship between pulse amplitude and electrode voltage is shown in Fig. 1.

A single positive ion and one electron are produced by the initial ionizing event: the collision of an alpha, beta, or gamma ray with a neon or argon gas molecule in the sensor. At

low voltages, region A in Fig. 1, the electron moves at low velocity to the central anode and the positive ion moves more slowly to the cathode, where they are neutralized. The detector is rarely operated in that region as extremely small pulses are generated. As the voltage is increased, the velocity and energy of the electron increases. At a specific threshold voltage, the start of region B, there is sufficient energy to produce more ions and electrons by additional collisions, and the pulse amplitude increases dramatically due to gas amplification. Region B is called the *proportional region* because the pulse size is dependent on the energy of the initial ionizing event.

Specialized instruments operating region B can distinguish between alpha, beta, and gamma rays by measuring the pulse amplitudes.

Region C starts when the gas amplification reaches saturation. The pulse amplitudes due to alpha, beta, and

gamma rays become essentially equal and increase only slightly with increasing voltage. Region C is the *Geiger region*; it has the highest sensitivity to incoming radiation. Most Geiger counters operate in region C.

When the voltage is increased beyond the Geiger region, the electric field becomes high enough to cause the gas to self-ionize. That occurs in region D and results in almost continuous discharge, which can only be stopped by turning off the voltage. Operation in region D can damage the tube.

The actual threshold voltages for each of the regions depend on the size and shape of the sensor and the configuration of the electrodes.

The thin wall of the Geiger tube allows high-energy beta and gamma rays to pass through and ionize the gas. However, alpha rays have considerably less energy and are blocked by the metallic tube. To detect alpha rays, a very thin mica disk or Mylar

film that is transparent to alpha rays is used in some Geiger tubes to close off one end of the cylinder. That end is called an *alpha window*. The alpha window must point toward the radiation source to detect alpha rays. The range of alpha rays in air is only about 3 centimeters.

Radon

The primary emissions from radon are alpha particles that rapidly dissipate in air. Secondary emissions of beta particles and gamma rays from radon, and from its decay products known as radon "daughters" or "progeny," occur in sufficient quantity to be detected. The EPA has published a booklet on measurement protocols for radon. The simplest technique uses a carbon canister to adsorb radon from the air for weeks or months. At the end of the measurement period the canister is sealed and returned to a laboratory for analysis.

Build a radiation monitor

But waiting for the results of laboratory tests is time-consuming, and if

the canister isn't placed in a "hot" spot, false low readings will result. You can do faster measurements by building our radiation monitor, which for simplicity we will henceforth refer to as the *Radalert*.

The Radalert, whose block diagram is shown in Fig. 2, is an extremely versatile Geiger counter that is sensitive to alpha, beta, gamma, and X-ray radiation. It is designed for ease of use by people who want to be better informed about the level of radiation that surrounds them. It also meets the needs of technical, medical, and public-service personnel who require accurate information involving the use, transportation, and storage of radioactive materials. A 4½-digit LCD display provides a direct reading of the number of ionizing events detected by the sensor. (A commercial version of Radalert is currently being tested at a major university laboratory to relate the total counts over extended time periods with calibrated radon levels to determine the time required to get useful results. Preliminary results indicate a 12-hour

count may be necessary to detect the increase in background radiation due to low levels of radon and its decay products.)

Two switches allow you to select the operating mode and type of display desired. With switch S2 set to the MUTE position, the COUNT LED visually indicates each ionizing event. When S2 is set to the COUNT position, you will also hear a beep corresponding to each count.

Switch S1 gives you a choice of two display modes. In the CPM (Counts Per Minute) mode, the number of counts detected each minute is displayed on the LCD until replaced by the next minute's count. No count is displayed during the first minute of operation, but the flashing LCD colon tells you that the count is in progress. In the TOTAL COUNT mode, the counts are accumulated and a running total is displayed.

A special feature of our monitor is a user-adjustable alert level. Using the CPM mode, the alert level can be set to a level greater than the normal background radiation. Using the TOTAL

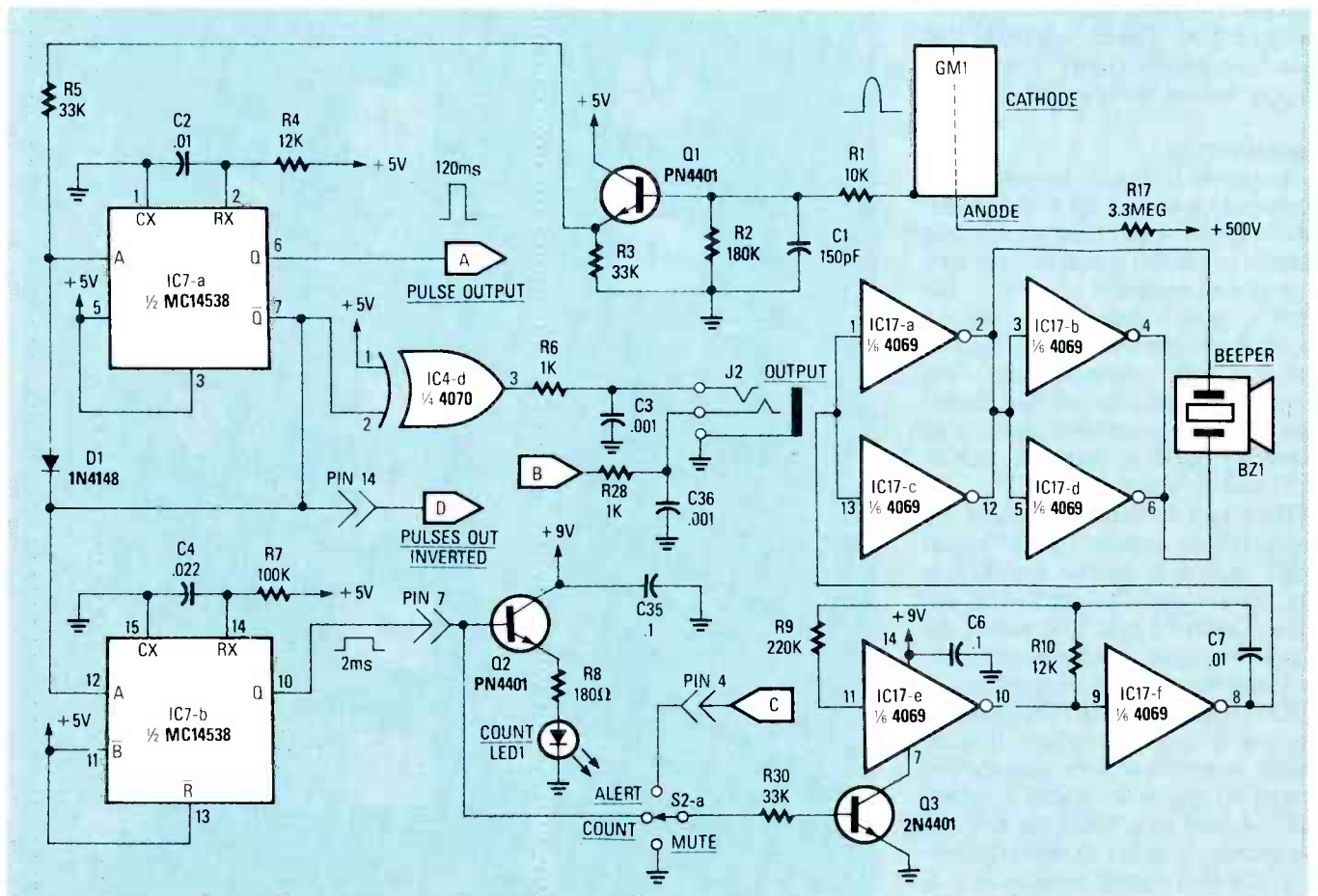

FIG. 3—THIS IS THE CIRCUIT FOR THE GEIGER TUBE and its pulse processor. LED1 blinks in step with each pulse. The beeper also can beep in step with each pulse, and can function as the alert alarm.

COUNT mode you can average the background radiation over long periods when testing for small changes in the background radiation. If S2 is set to its ALERT position, a pulsating beep lets you know when the count reaches the preset alert level.

Portable operation

The monitor is powered by a transistor-radio type 9-volt battery. Very low current drain allows up to 6 months operation before the LO BAT (low battery) indication appears on the LCD display. For continuous 24-hour operation over long periods, the Radalert can be powered by an optional AC adapter connected to EXTERNAL-POWER-jack J1. Notice from Fig. 2 that the battery is not disconnected when the AC adapter is connected to J1. That arrangement permits the battery to automatically take over if the AC powerline fails, thereby assuring uninterrupted measurements. A diode prevents the AC adapter's output voltage from being applied to the battery.

A 500-volt regulated power supply operates the radiation sensor in the Geiger region. The crystal-controlled time-base for the COUNTS PER MINUTE display has an accuracy of 0.005%.

How it works

As shown in Fig. 2, the high-voltage supply is connected to the Geiger tube's anode. Each time an ionizing particle or photon penetrates the tube it creates an avalanche of current. The current pulse is detected and shaped by the Radiation Pulse Processor, and then sent to the counter sections of the display and alert circuits. The Radiation Pulse Processor also provides an extended pulse to drive the COUNT LED and the Piezo Beeper.

The Clock Generator produces the timing signals required by the Control Logic section to operate the Display and the Display Counter/Driver circuits. Control Logic also resets the Clock Generator, and the Alert Counter/Comparator at the proper times.

The Alert Counter/Comparator section accumulates the radiation counts and compares the count to the setting on the binary-coded switches (S3, S4, and S5). When the level on the counter is equal to the BCD setting, the alert output pulsates at a 2-Hz rate to drive the Piezo Beeper when the Audio Mode Switch (S2) is in the ALERT position.

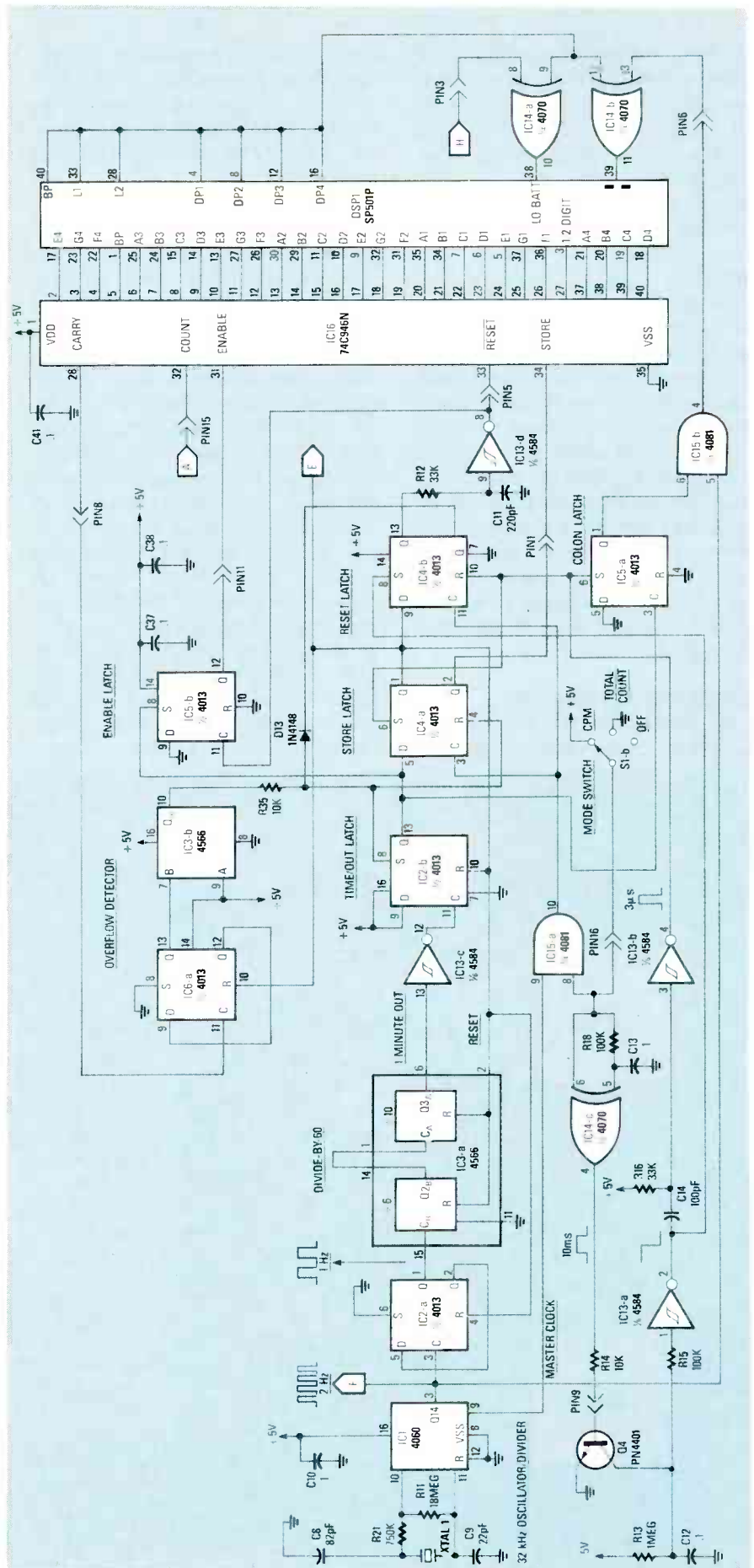

FIG. 4—THE CONTROL LOGIC. A 32-kHz master clock is divided down to provide the one-minute timing for the counts-per-minute function.

PARTS LIST

All resistors are 1/8-watt, 5%, unless otherwise noted.

R1, R14—10,000 ohms
 R2—180,000 ohms
 R9, R33—220,000 ohms
 R3, R5, R12, R16, R30—33,000 ohms
 R4, R10—12,000 ohms
 R6—1000 ohms
 R7, R15, R18—100,000 ohms
 R8—180 ohms
 R11—18 megohms
 R13, R20—1 megohm
 R17—3.3 megohms, 1/2 watt
 R19—2.2 megohms
 R34—47,000 ohms
 R21—750,000 ohms
 R31, R32—100 ohms
 R22—4700 ohms
 R23—1 ohm
 R24—510,000 ohms
 R25, R26—3.9 megohms
 R27—390,000 ohms
 R28—1000 ohms
 R29—10 megohms
 RN1, RN2—220,000 ohm × 6 resistor network

All capacitors rated at least 15 volts, unless otherwise noted

C1—150 pF, 5%, polyester
 C1, C11—220 pF, 5%, polyester
 C2—0.01 μ F, ceramic disc, type X7R
 C3, C10, C15, C19, C28, C33, C34, C36—0.001 μ F, ceramic disc
 C4—0.022 μ F, ceramic disc, type X7R
 C5, C25, C26, C30, C31—not used
 C6, C10, C12, C13, C17, C28, C29, C35, C39, C41—0.1 μ F, ceramic disc
 C7, C29—0.01 μ F, ceramic disc
 C9—22 pF
 C8—82 pF
 C14—100 pF
 C16—0.022 μ F

C18, C37—47 μ F, electrolytic
 C20, C21, C22, C23, C24—0.0047 μ F, 1KV, ceramic disc
 C27—10 μ F, tantalum
 C32—0.0027 μ F, ceramic disc
 C38—10 μ F, electrolytic

Semiconductors

IC1—4060 oscillator/counter
 IC2, IC4, IC5, IC6—4013 dual D flip-flop
 IC3—4566 time-base generator
 IC7—4538 dual multivibrator
 IC8, IC9, IC10—4585 4-bit comparator
 IC11, IC12—4518 dual BCD counter
 IC13—4584 hex Schmitt trigger
 IC14—4070 quad exclusive OR
 IC15—4081 quad AND
 IC16—74C946 counter/decoder/driver
 IC17—4069 hex inverter/buffer
 IC18—MAX666 micropower regulator
 DSP1—4 1/2-digit LCD display, Seiko SP501P
 Q1—Q5—PN4401 transistor
 Q6, Q7—MPS6515 transistor
 Q8—PN3906 transistor
 D1, D10—1N4148 diode
 D2—Not used
 D3—D6, D12—1N4007 diode
 D7—D9—1N5278B diode
 D11—1N5819 diode
 D13—1N4148 diode
 LED1—Light-emitting diode

Other components

B1—9 volt battery
 BZ1—piezo-electric beeper, Kyocera KBS-27DB-3T
 GM1—Geiger tube, type LND 712
 J1—miniature jack
 J2—miniature 2-circuit jack
 S1, S2—DPDT slide switch
 S3, S4, S5—BCD rotary switch, right angle mount

T1—DC/DC blocking transformer
 XTAL1—32.768 kHz crystal, watch type

Miscellaneous: Samtec 16-pin male and female connectors, cabinet, printed-circuit materials, wire, solder, cabinet, etc.

Note: The following components are available from International Medcom, 7497 Kennedy Rd., Sebastopol, CA, 95472:

T1, \$3.75; DSP1, \$10.00; set of two double-sided, plated through printed-circuit boards, \$16; GM1, \$45. Add \$1.00 for shipping and handling for those components. California residents must add appropriate sales tax.

A complete kit, which includes the two printed-circuit boards, the plastic enclosure with custom modifications, labels, all components, hardware, assembly instructions and an operating manual, is available for \$149.50 (without battery).

A completely assembled and tested Radalert with an operating manual is available for \$225 (including battery).

Add \$4.00 for shipping and handling to each Radalert or Radalert kit order. California residents must add appropriate sales tax.

To order the complete kit or the assembled Radalert by Visa or Mastercharge call toll free 1-800-257-3825. In California, call 1-800-255-3825. (Those numbers are for credit-card orders only. For technical information contact International Medcom at the above address.

The circuit

As shown in Fig. 3, the cathode of Geiger tube GM1 returns to ground through Q1's base. The current pulse created in the Geiger tube by a radiation event is about 50 to 75 microseconds long. It pulls up R1, thereby raising Q1's base voltage and turning Q1 on for the duration of the ionizing event. That, in turn, pulls up emitter resistor R3, bringing pin 4 of IC7-a high, which causes the Q output to go high, thereby producing a square wave about 120 microseconds long (the length is determined by the time-constant of R4/C2).

Since \bar{Q} , pin 7, is always the opposite of Q, it goes low, pulling the A input low again through D1. The \bar{Q}

output to A ensures that the circuitry will continue to count at extremely high radiation levels and not saturate or "jam." The Q output is connected to the display and alert counters. The \bar{Q} output is used by the alert circuit and is also buffered through IC14-d and R6 to the Count Output port (J2's tip), which is the interface to a computer or other data logging device.

One section of IC7, IC7-b, is used as a pulse extender to drive LED1 and beeper BZ1. The pulse width, about 2 milliseconds, is determined by the time-constant of R7/C4.

Beeper BZ1 is driven in a push-pull configuration by two sets of paralleled buffer/inverter gates from IC17. The other two gates of the device are

configured as a 3.3-kHz oscillator to match the resonant frequency of BZ1. The oscillator's frequency is determined by the values of resistors R9 and R10, and capacitor C7. The circuit is very efficient, providing a sound pressure level of about 75 dB at 12 inches, with a current drain of 2 mA.

Since the drain is only on for 2 milliseconds per count, that 2 mA averages out to only 1 μ A at normal background radiation levels of about 15 counts per minute.

Although LED1 draws 15 mA when it is on, the average current drain is still in the low microampere range. Indicators LED1 and BZ1 are switched by Q2 and Q3, respectively.

LCD display

The 4½-digit liquid-crystal display, DSPI, is the non-multiplexed (direct drive) type. As shown in Fig. 4, it is driven by IC16, a National Semiconductor 74C946, which features 100-microwatt power consumption and leading-zero blanking. It has internal counters for each of the 4 digits and a flip-flop to drive the ½ digit.

The pulses from IC7-a, pin 6 (Fig. 3), are fed to IC16's COUNT INPUT, pin 32. Every negative-going transition clocks the internal counter chain. The

STORE pin, pin 34 of IC16, controls the counter latches.

In the TOTAL COUNT mode, pin 34 is low, the latches are in a flow-through state, and counts are actively displayed as they are detected. In the COUNTS PER MINUTE mode, pin 34 is high, and the counter latch outputs are stored. Each minute, CONTROL LOGIC disables the counter, pin 31, while the prior minute count is displayed and stored (pin 34). The counter is then reset to zero (pin 33) to start the count for the next minute.

Clock generator

All timing waveforms are referenced to a 32.768 kHz crystal oscillator built into IC1. That IC has a 14-stage ripple-carry counter that divides the oscillator frequency by two 14 times to give a 2-Hz output at pin 3. The IC2-a flip-flop divides the 2 Hz by two again to furnish a 1-Hz signal to IC3, a 4566 industrial time-base generator that was described in detail in the January, 1988 issue of **RADIO-ELECTRONICS** (see page 56). The time-base generator divides the 1 Hz, first

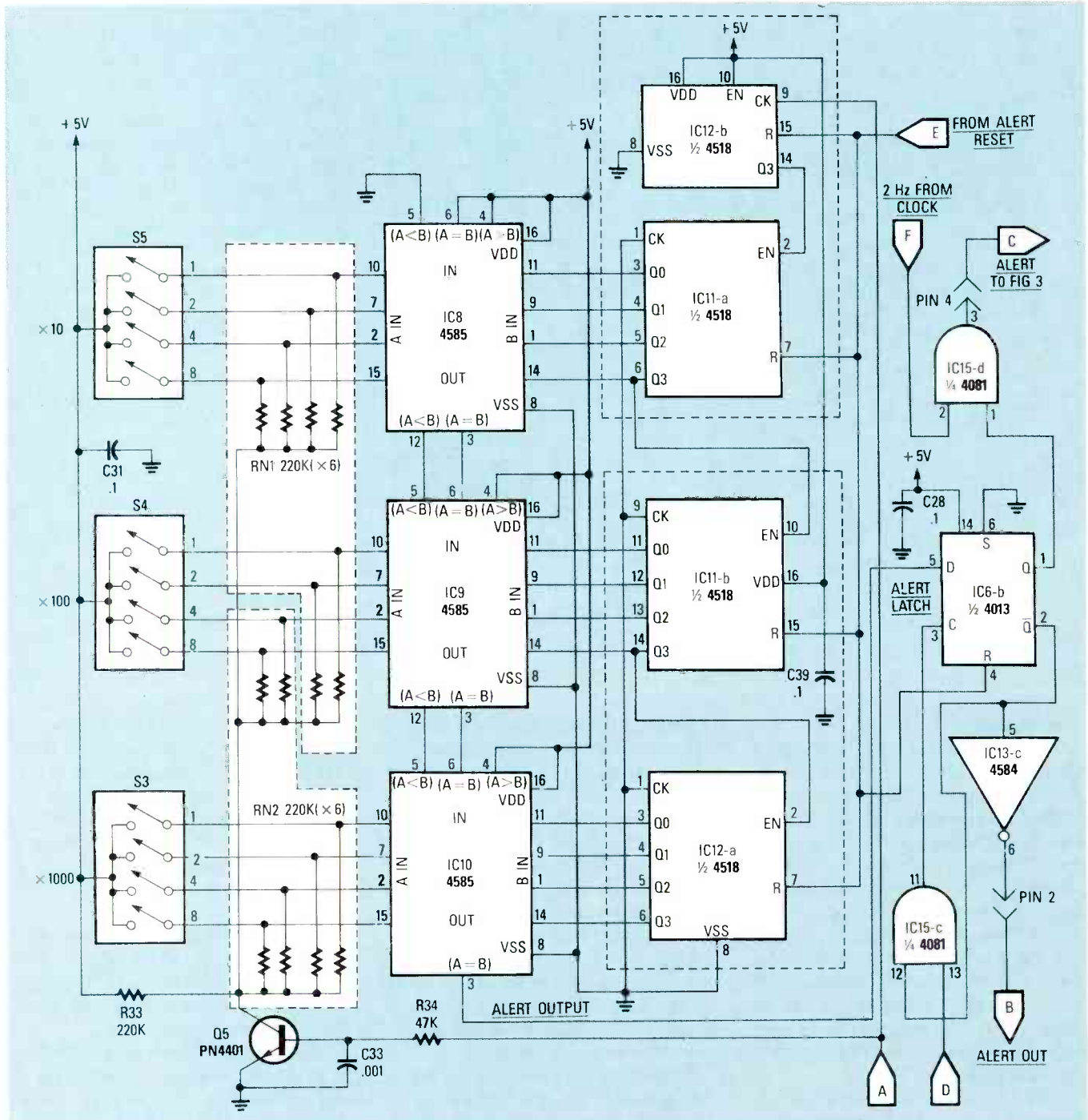

FIG. 5—THE ALERT COUNTER is user programmed through switches S3, S4, and S5.

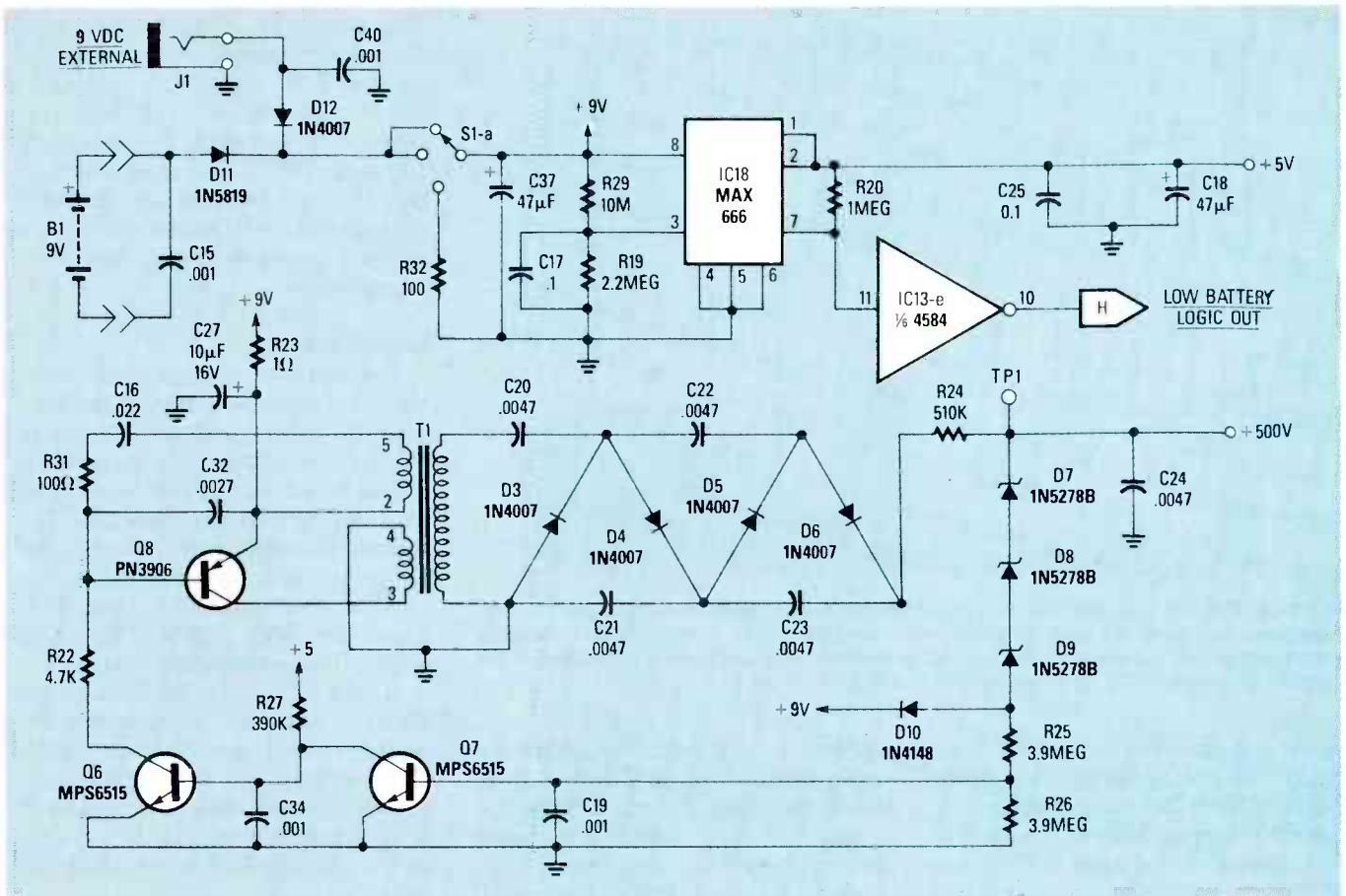

FIG. 6—THE 500 VOLTS DC for the Geiger tube is generated by the DC-to-DC converter circuit consisting of Q6, Q7, Q8, and their associated components.

by six and then by 10, to provide the 1-minute timing signal for the COUNTS PER MINUTE mode. One minute is up when pin 6 goes low; the transition is inverted by Schmitt trigger IC13-c.

Control logic

Refer to Fig. 4. The power up/reset sequence starts when the Radalert is turned on. Capacitor C12 charges through resistor R13, causing IC13-a, pin 2, to go low. Capacitor C14 is momentarily discharged, then recharged through R16. The recharge time is set by the R16/C14 time constant and creates a 3-microsecond power up/reset pulse at IC13-b, pin 4.

Whenever S1 is switched between COUNTS PER MINUTE and the TOTAL COUNT modes, IC14-c, pin 6, goes either positive or negative, with a time delay determined by R18/C13. That section of IC14 is configured as a one-shot that can be triggered on a positive or negative transition, and its output will be high when pin 5 and pin 6 are unequal. The R18/C13 time delay makes them unequal for a very short time, creating a 10-millisecond positive pulse at pin 4 that turns on

Q4. The Q4 collector momentarily discharges C12 to re-initiate the power up/reset sequence.

In the COUNTS PER MINUTE mode, critical timing of the IC16 ENABLE, RESET, and STORE functions is implemented by four D flip-flops: IC2-b, the Time Out latch; IC4-a, the Store latch; IC4-b, the Reset latch; IC5-b, the Enable latch. In the TOTAL COUNT mode, IC15-a inhibits the Master Clock, allowing the radiation count-data from the Pulse Processor to accumulate on the display.

A count of 19999 triggers the overflow detector, freezing the display at that value, and providing a time out signal in COUNTS PER MINUTE mode. In the TOTAL COUNT mode, the 19999 remains on the LCD until S1 is switched.

The colon at the left end of the LCD display flashes at a 2-Hz rate in the first minute of the COUNTS PER MINUTE mode. In the TOTAL COUNT mode, the colon continues to flash as counts are accumulated. A D flip-flop, IC15-a, controls those functions.

Alert counter and comparator

Refer to Fig. 5. Two 4518's, IC11

and IC12, form a chain of four BCD up-counters. Counts from the Pulse Processor feed the least significant digit of the chain, IC12-b, pin 9. The counts are incremented by the $\times 10$, $\times 100$, and $\times 1000$ registers, IC11-a, IC11-b, and IC12-a. Register outputs are compared to the settings of the BCD ALERT LEVEL switches (S3, S4, S5) by IC8, IC9, and IC10. To conserve battery life, comparison is made only as each count is detected. When the alert level is reached, a true alert output is clocked into the Alert Latch IC6-b to energize the beeper at a 2-Hz rate (if S2-a is set to ALERT). The latch then disables any more pulses from clocking through IC15-c.

Power supply

As shown in Fig. 6, the Radalert operates from an internal 9-volt battery, or an external 9-volt power source. Capacitors C15 and C28 are RF-bypass capacitors. External power supply jack J1 does not disconnect the battery when external power is used so that the Radalert will continue to function on battery power if the AC power fails. Diode D11 is a Schottky

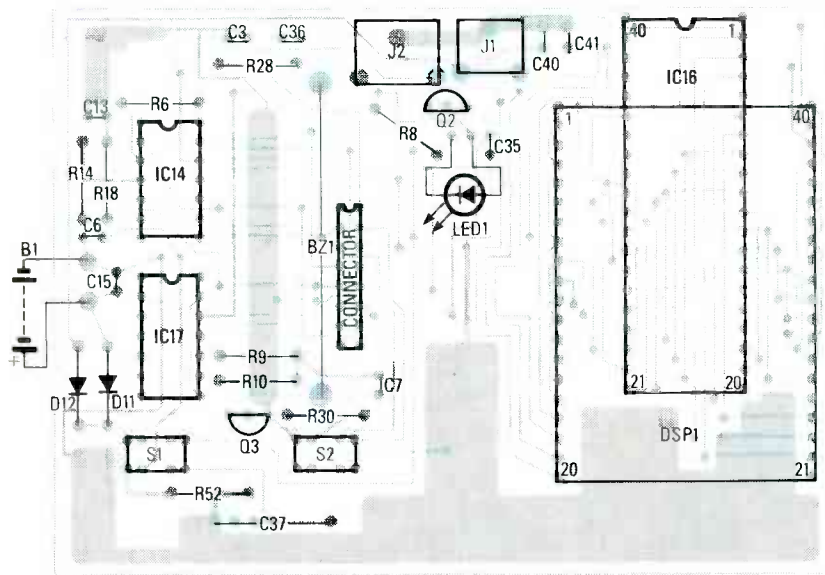

FIG. 7—BOTH THE BEEPER AND THE LCD DISPLAY are on the same board. Take extreme care when handling the display. While not unusually fragile, it nevertheless requires somewhat gentle handling during assembly. Parts IC16, J1, J2, and the connector are actually mounted on the underside of the board.

diode that prevents the battery from being charged by the external power supply. Diode D12 protects the battery from discharging if there is a short in the external power source. Capacitor C37 filters the unregulated 9-volt line that powers the high voltage power supply, LED1, and BZ1.

Switch S1 turns the RadaAlert on. A MAX666 regulator, IC18, provides regulated 5 volts to the LCD and all the other IC's. That regulator is unusual in that it contains a built-in low-battery detector. The threshold is set by the ratio of R29 and R19. The voltage at pin 3 is compared to an

internal 1.3-volt reference. When the input voltage falls to a level that reduces the voltage at pin 3 below 1.3 volts, then pin 7, which is normally held high by R20, goes low. A logic high signal is required to indicate LO BAT on the LCD display, so the state of pin 7 is inverted by IC13-e, an inverting Schmitt trigger.

The high-voltage circuit provides regulated 500 volts at up to 50 microamps, as required by the Geiger tube. It uses a DC-to-DC blocking-oscillator design and closed-loop feedback regulation. Transistor Q8 oscillates at approximately 25 kHz.

Transformer T1, in combination with the voltage multiplier formed by capacitors C20, C21, C22, and C23, and diodes D3, D4, D5, and D6, steps up the voltage to approximately 500 volts. The Zener diode chain of D7, D8, and D9 provides feedback through Q7 and Q6, to maintain a constant output-voltage at minimum current drain.

Construction

The unit is assembled on two double-sided printed-circuit boards; templates for those boards are provided in PC Service. Alternately, etched and drilled boards can be purchased from the source given in the Parts List. The plastic enclosure shown in the prototype is available from Bopla Enclosure Systems, P.O. Box 649, Rockville, MD. 20851. (Write for latest price and shipping charges.)

All the IC's used in the RadaAlert are CMOS, so when stuffing the PC boards avoid building up static charges that might damage the IC's. We suggest wearing a grounded wrist strap when handling the IC's. Also, use a grounded (3-wire) soldering iron.

The location of all components is silk-screened on the pre-drilled printed-circuit boards. If you make your own boards, refer to Figs. 7 and 8 for the parts-placement. Double check the placement and the polarity of diodes, electrolytic and tantalum capacitors, and the orientation of all transistors, IC's, and switches before soldering. Install the BCD ALERT switches, S3, S4, and S5, with their screwdriver slots facing away from the board. And because there is little clearance between the boards, make certain all components except the LCD display are pressed against its board before soldering.

The LCD display is mounted by pressing it against the window in the cabinet, not against the printed-circuit board. Like the IC's, the display is also static-sensitive, so handle it with care.

Because the high voltage section delivers 525 volts DC, do not handle the bottom (high-voltage) printed-circuit board during assembly and testing when the power is on. After testing, an anti-corona conformal coating (such as Dow Corning No. 1-2577) should be applied to the components and both sides of the

continued on page 102

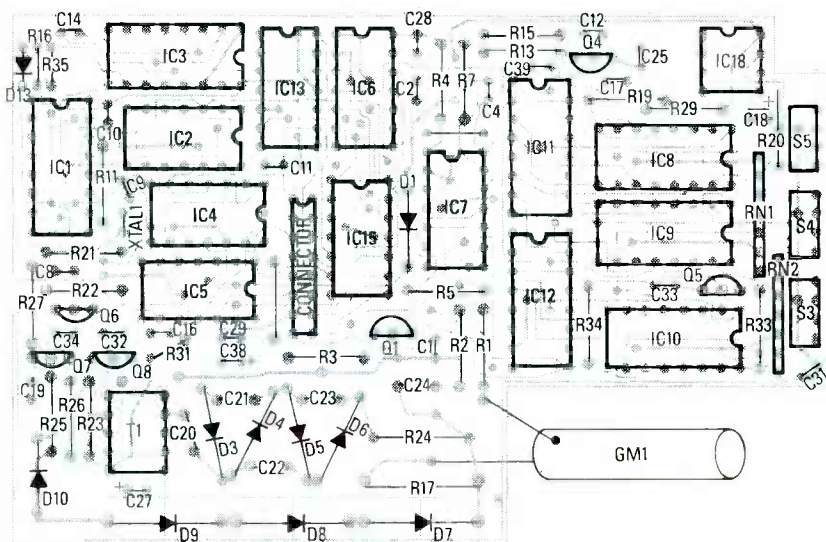

FIG. 8—NOTICE THAT THE BCD SWITCHES that set the alert level mount along the smaller edge of the printed-circuit board. To ensure that their adjustments align with their cabinet cutouts, be sure the switches are pressed against the printed circuit board when being soldered.

BUILD THIS

Don't let summer heat dry your plants out! Keep them properly watered with this inexpensive digital moisture meter.

FEW THINGS ARE MORE FRUSTRATING than planting a fancy new hybrid rose and finding, a few days later, that it died because it didn't receive enough water. You can avoid dehydrating your plants with our digital moisture meter. It can help you keep all your plants—indoors and out—in tip-top condition by indicating when a plant needs water. In addition, it will help you from overwatering your plants; overwatering can be just as detrimental as underwatering. The circuit is inexpensive (under \$30), and it can be put together in an evening or two.

To obtain a digitally-accurate read-out of moisture content, just turn the meter on, insert the probe into the earth beneath your plant, and read the three-digit LCD display. A rose bush, for example, needs a moisture level between 70 and 80 (on the scale developed by our meter). If the measured level is equal to or higher than that, the plant needs no additional water. The instruction manual that comes with the probe (discussed below) contains information about the proper moisture level for many varieties of plants.

How it works

The moisture meter's circuit is shown in Fig. 1; IC1, an Intersil ICL7106, is the heart of the circuit. It contains an A-to-D (Analog-to-Digital) converter, a 3½-digit LCD driver, and all necessary support circuitry, including a clock, a voltage reference, and seven segment decoders and display drivers. A similar part, the ICL7107, can be used to drive seven-segment LED's.

The sensor probe is similar to one used in Radio-Shack's *Plant Light and Moisture Meter*, which is no longer sold. If you already own one of those units, you can simply remove the probe and attach it to the circuit. Otherwise, you can build a suitable probe using common materials.

The construction of the probe is shown in the photograph of Fig. 2.



SOIL MOISTURE METER

RICARDO JIMENEZ AND
CLEMENTE GARCIA

The body is a five-inch length of lightweight aluminum tubing. A suitable body can be salvaged from an old TV or radio telescoping antenna. The probe tip is made from a small, ¾-inch long, ⅛-inch diameter solid aluminum rod. File down ¼-inch of the rod to a diameter of about ⅛-inch. File the remainder of the rod to a rounded point.

The leads from the circuit are connected to the body and tip of the probe. The leads are held in place using the two caps shown. In addition, the forward cap provides electrical insulation between the probe tip and body. The caps are simply end caps salvaged from old BIC ballpoint pens.

To build the probe, start by drilling small holes through the pen caps.

Pass both wires through the pen cap. Then pass one of the wires through the probe body and the forward cap. Strip about ¼-inch of insulation from that wire. Next insert the forward cap into the probe body and finish up by inserting the probe tip into the forward cap in such a way that the stripped wire is pinched between the cap and the tip. Finally, trim the second wire to an appropriate length, strip about ¼-inch of insulation from the end, and insert the rear cap so that the stripped end is pinched between the probe body and the cap.

The sensor functions as a variable resistor that varies Q1's base current, hence its collector current. That varying collector current produces a varying voltage across 100-ohm resistor

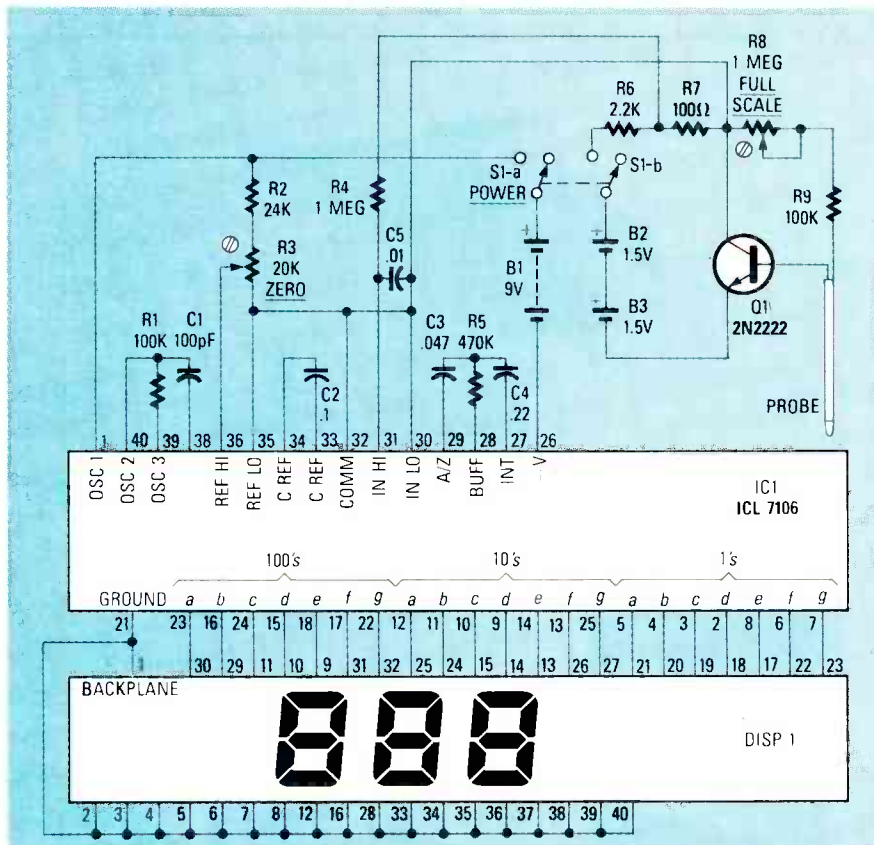

FIG. 1—MOISTURE METER'S COMPLETE SCHEMATIC is shown here. Only one IC is required; the entire circuit can be put together for about \$30.

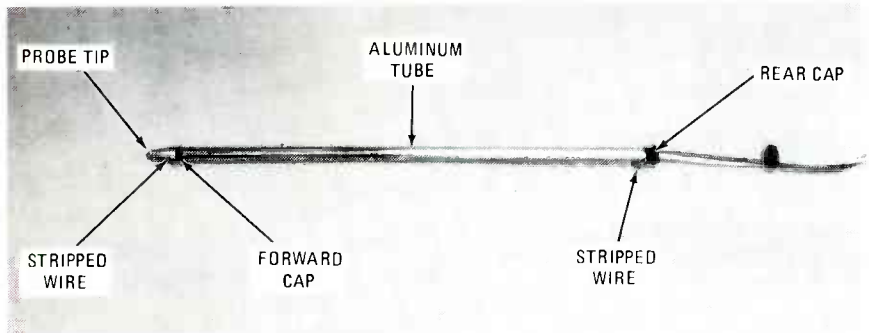

FIG. 2—THE SENSOR PROBE shown here can be built from common household items. The end caps, salvaged from inexpensive ballpoint pens, are used to hold the leads in place without soldering.

R7, and that voltage is what IC1 converts for display.

The LCD specified in the Parts List is actually a 4½-digit device; it also contains periods and colons between digits, and a leading plus sign. All unused characters are simply tied to pin 1 (BACKPLANE) to avoid erroneous displays and excessive power consumption.

The LCD consumes about 25 microamperes, and IC1 consumes under 2 mA, so the circuit will run for a long time when it is powered by a standard 9-volt battery. Current drain of the two 1.5-volt AA cells is also very low: under 300 µA.

Construction

Any convenient construction technique may be used. We used several pieces of pre-etched perfboard to mount all components except the power switch and the batteries. The LCD mounts on one board, and IC1 and the remaining components mount on the other. Short lengths of hookup wire connect appropriate points on the two boards.

Everything except the probe mounts in a plastic case that measures approximately 2 × 3¼ × 6 inches. A small hole, through which the probe wires pass, is drilled in the side of the case. A ⅞ × 2 (inches) rectangular

PARTS LIST

All resistors are ¼-watt, 5%.

- R1, R9—100,000 ohms
- R2—24,000 ohms
- R3—20,000 ohms, trimmer potentiometer
- R4—1 megohm
- R5—470,000 ohms
- R6—2200 ohms
- R7—100 ohms
- R8—1 megohm, trimmer potentiometer

Capacitors

- C1—100 pF, ceramic disk
- C2—0.1 µF, mylar
- C3—0.047 µF, mylar
- C4—0.22 µF, mylar
- C5—0.01 µF, mylar

Semiconductors

- IC1—ICL7106, A/D converter & LCD driver (Intersil)
- Q1—2N2222

Other components

- DISP1—LCD display, Amperex LC513041-301.15/IS (Digi-Key part no. LCD004)
- S1—SPDT slide or toggle switch
- Probe—see text

Miscellaneous: Perforated construction board, plastic case, wire, solder, etc.

hole is cut in the front of the case; the LCD is visible through that hole. Last, another small hole must be cut for S1.

The probe cord should be pushed through the hole in the case. Tie a knot in the cord for strain relief, and then solder the ends to Q1 and R9.

Check your work carefully. When you're satisfied that you've made no errors (or after you've fixed them), you're ready to calibrate the meter.

Calibration

First rotate R3 to the center of its range. Then place the end of the probe into a glass of water and adjust R8 for a reading of 100. When you remove the probe from the water, the LCD should indicate 000. You may have to adjust R3 slightly for the display to indicate 000. If so, re-adjust R8 with the probe immersed. Check for a reading of 000 again with probe out of water. After the resistors are adjusted, screw the case together.

Now you have one less excuse for not keeping your flowers and plants blooming beautifully!

R-E

Build REACTS: THE RADIO-ELECTRONICS ADVANCED CONTROL SYSTEM

This month, we show you how to put REACTS to work to control the outside world.

Part 5 IN THE PREVIOUS articles in this series we built the basic REACTS control computer. In this article we will discuss how the REACTS can perform useful tasks; that is, provide automatic control for the home. We will build an electronic lock and provide automatic control of various appliances in the home. In a future article we will add a security system and we will also provide automatic environment control.



H. EDWARD ROBERTS

What makes control applications like those possible is an eight-channel input and output block that we will use to provide partial automation of a home. Specifically, we will build an electronic door lock and provide for the automatic sequencing of appliances and lights.

What we will show you this month is just a small portion of our ultimate home-control system. In future articles we will add capabilities such as environmental control and a security system. The reader should notice that the application shown is designed to be both practical as well as illustrative; we hope it will

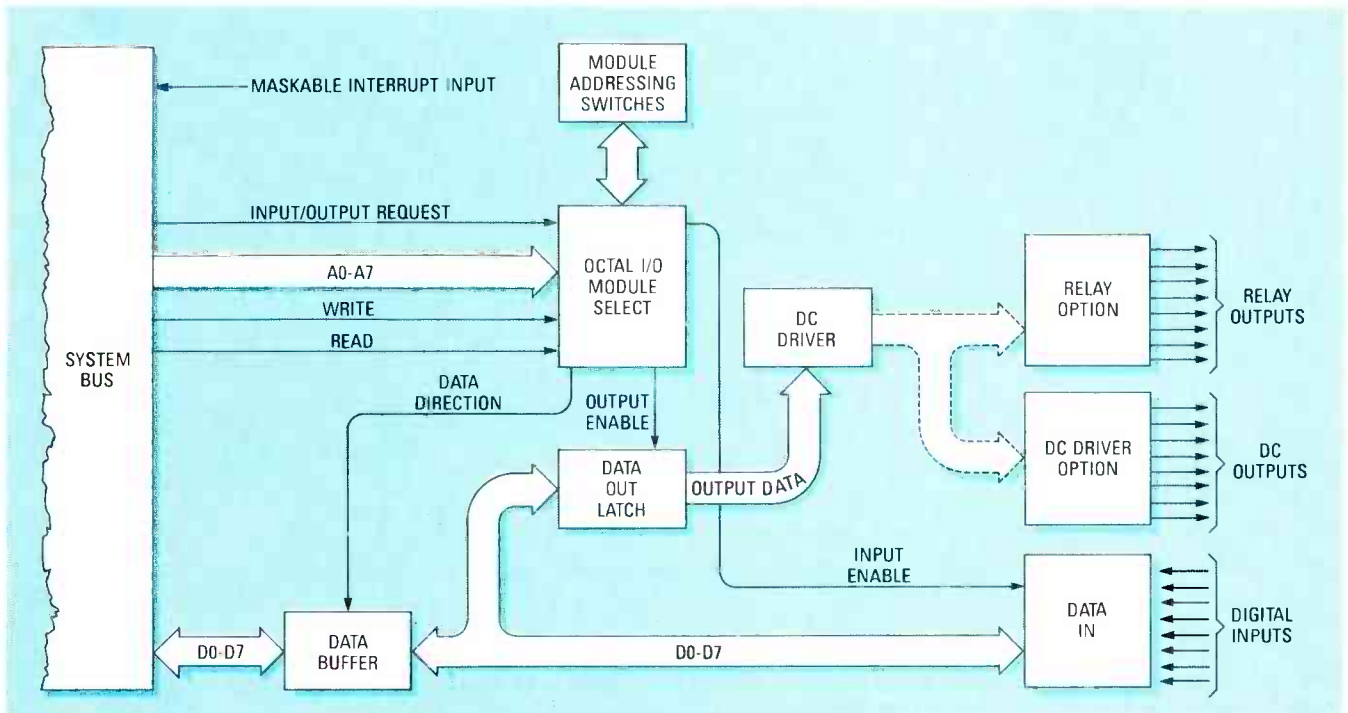

FIG. 1—THE REACTS OCTAL I/O MODULE allows you to interface the system to the outside world. The optional relay outputs even allow you to control AC devices.

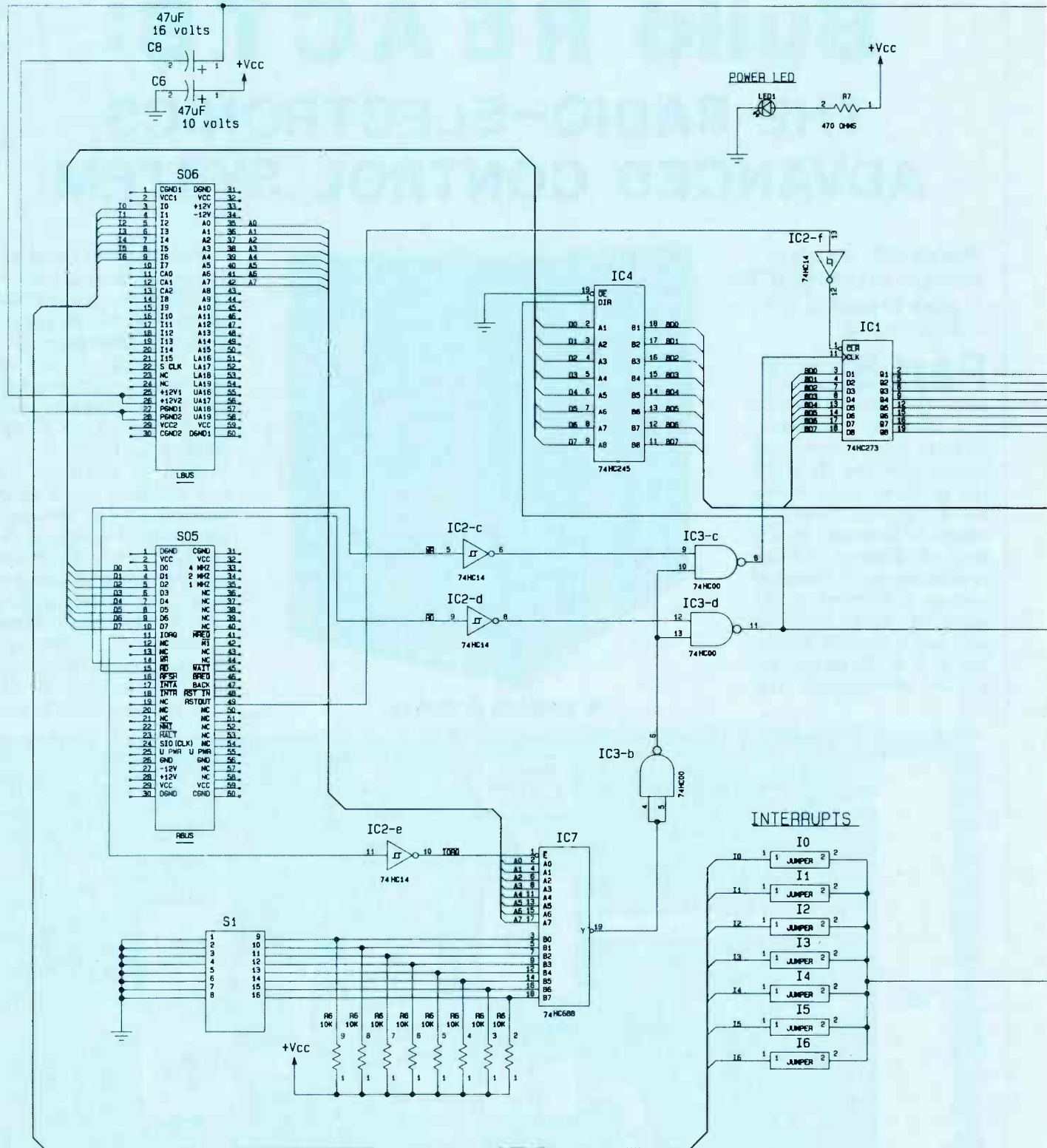
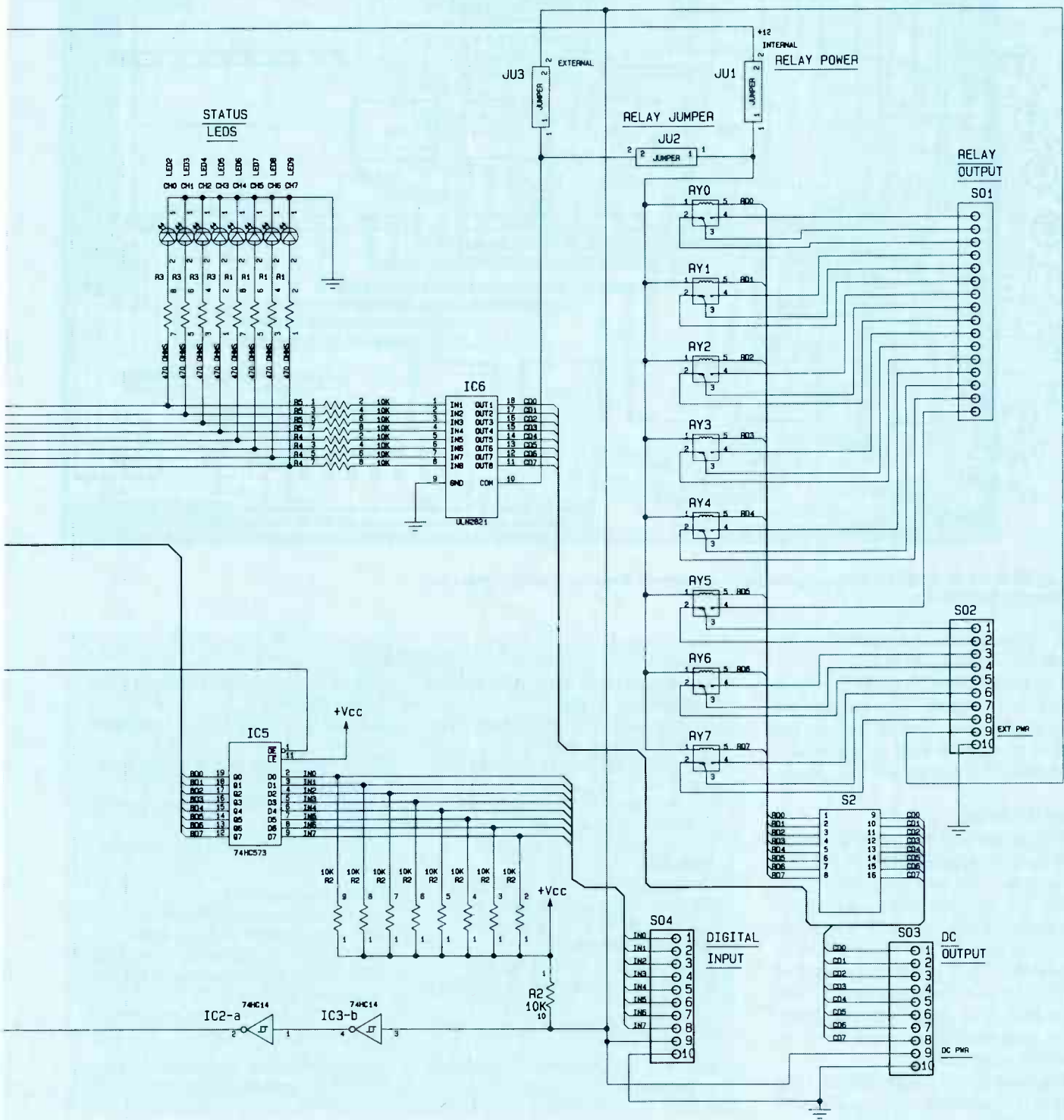

FIG. 2—CIRCUIT DETAILS of the module are shown in this schematic. Switch S1 allows you to change the module's port address as needed.



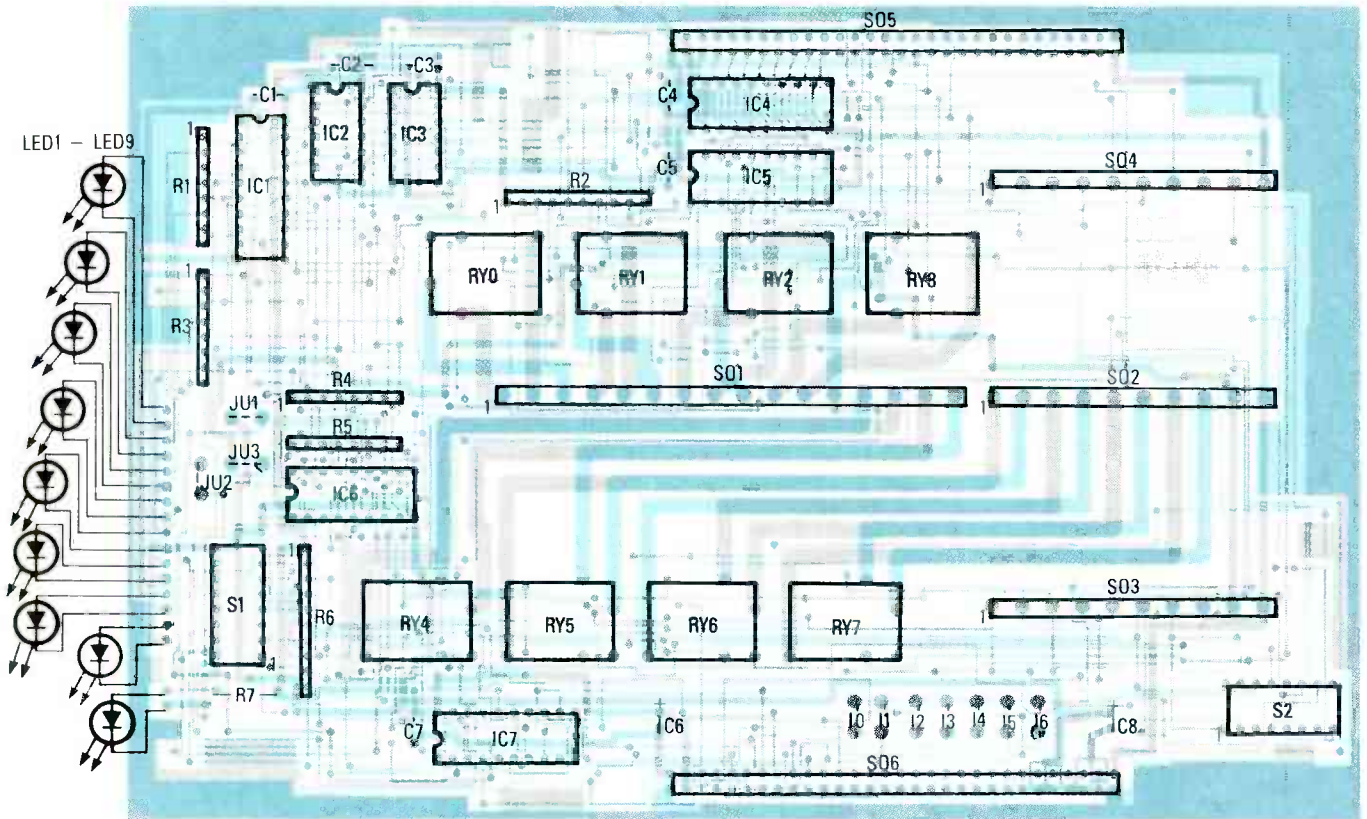

FIG. 3—BUILD THE MODULE following this parts-placement diagram. The PC pattern can be found in PC Service.

give you some idea on how to use the REACTS control computer.

The I/O module has eight universal inputs and outputs. The outputs are eight Darlington-array DC drivers (an option of eight 6-amp relays is also available). The inputs are TTL level.

How it works

Before we proceed, a brief review of the input/output system of the Z80 is in order. As you may remember, REACTS has 256 input and output channels. Each channel has eight lines that may be set on or off independently. That gives us a total of 2048 (256×8) potential switch closings and 2048 input sensing lines; more than enough for even the most complex application.

Each input and output channel has a specific address; i.e., address 0 through 255. Let's look at how a computer performs a typical input operation. All microprocessors operate using a cycle system. Each cycle performs one type of operation, such as a memory read, a memory write, an I/O input, an I/O output, etc. Using the status lines, the processor "tells" the rest of the system what it is going to do at the beginning of each cycle. The

All resistors 1/4 watt, 5%, unless otherwise noted

- R1, R3— 4×470 ohms, isolated resistor network, SIP
- R2, R6—10,000 ohms, 9-into-1 resistor network, SIP
- R4, R5— $4 \times 10,000$ ohms, isolated resistor network, SIP
- R7—470 ohms

Capacitors

- C1—C5, C7—0.47 μ F, ceramic disc
- C6—47 μ F, 10 volts, electrolytic
- C8—47 μ F, 16 volts, electrolytic

Semiconductors

- IC1—74HC273 octal D flip flop
- IC2—74HC14 inverting Schmitt trigger
- IC3—74HC00 quad 2-input NAND gate
- IC4—74HC245 octal three-state transceiver

signals on the status lines identify the type of operation to be performed. For instance, if the system is going to perform an input, the IORQ (INPUT/OUTPUT REQUEST) line becomes high. That tells the system that the operation is to be either an input or an output. The system decides whether or not the operation is an input or an

PARTS LIST

- IC5—74HC573 octal three-state D-type latch
- IC6—ULN2821 Darlington transistor array
- IC7—74HC688 8-bit magnitude comparator
- LED1—red LED, right-angle PC mount
- LED2—LED8—green LED, right-angle PC mount

Other components

- S1, S2—8-position DIP switch
- SO1—16 position terminal strip
- SO2—SO4—10 position terminal strip
- SO5, SO6—60-pin male and female bus-connector set
- RY1—RY8—6-amp relay, PC mount (optional, see text)

Miscellaneous: PC board, hardware, IC sockets, case, etc.

output by "looking" at the RD (READ) and WR (WRITE) lines. If the RD line is low the cycle is an input, if the WR line is low the cycle is an output.

So far we have determined that the particular cycle is an input based on the IORQ and the RD line. But which of the 256 possible inputs is to be used. That is determined by simply looking

at the lower eight address bits. Those bits will be set with the correct address (i.e., the address of the required input channel) at the beginning of the cycle. That's all there is to it. Note that all eight lines will be read in at one time. Now let's look at how that operation appears to the software. Using BASIC, the command to input the data would be as follows:

```
40 X = INP(23)
```

That command instructs the computer to input channel 23 and store its eight lines in a variable called X. You will see later how we are able to separate the individual lines from the variable.

Module operation

Referring to Fig. 1, a block diagram, and Fig. 2, a detailed schematic of the I/O module, will be of great help to you in following the module operation discussion.

The octal I/O module provides eight digital inputs and a choice of eight DC or relay-isolated outputs (note the dotted bus line on the block diagram of Fig. 1). Only one of the module's output options (either DC or relay) can be used at a time; however, room is left on the printed-circuit board to install terminal strips (the external devices to be controlled are connected to those) for both. Selecting between the DC or relay option is accomplished by simply moving a few power jumpers and setting some switches. That capability to readily change between output options is useful when developing an applications system.

The module's circuitry performs three main functions: module selection, data output (activation of the DC or relay outputs), and data input.

Module selection occurs when the A (A0-A7) inputs of IC7, a 74HC688 eight-bit magnitude comparator, match its B (B0-B7) inputs and the IORQ line is active. Note that the B inputs of IC7 are connected to a bank of eight switches while the A inputs are connected to the lower eight address lines. That allows the input/output port used by the module to be user-selectable. That is, the module will be selected only when the IORQ line is active and the I/O address on the lower eight address lines matches the I/O address selected via the bank of switches.

Data input occurs when the module

SOURCES

The following items are available from DataBlocks, Inc
579 Snowhill Road, Glenwood GA.
30428. Or call (800) 652-1336; in
Georgia call (912) 568-7101.

- DP-OCT: Design package with schematic and instructions; \$10.00.
- PC-OCT: PC board for the octal I/O, including design package; \$37.00.
- REC-OCT: Complete set of parts including PC board, IC's, terminal strips, etc., but excluding relay option listed below; \$109.00.
- REC-REL: OCTAL I/O relay option includes eight, 6-amp relays and terminal strips; \$42.00.

is selected and the RD line is low. That places the data at terminal strip SO4 onto the system data bus by enabling the 74HC573 latch (IC5) and changing the data direction flow of the 74HC245 buffer (IC4) so that data flows from the B side to the A side. Since no CMOS inputs should be left floating, pull-up resistors have been connected to the inputs of IC5.

With the inputs pulled high, an open input (i.e. one that is not connected to any external device) will cause the corresponding bit to be high (logic 1). The fact that the inputs are pulled high should be taken into consideration when developing software for the module. That is, we normally think of a logic 1 as being "on" and a logic 0 as being "off". With an open input that is pulled high, or with an open switch connected to the input, a logic 1 will be input. Although that is perfectly legal, it tends to be contrary to our normal way of thinking. The simplest way to remedy this is to complement the input(s). Another solution would be to use a normally closed switch. In the doorlock-application programs we will discuss shortly, we use the NOT command to complement the inputs.

When the module is selected and the WR line is low, the data on the system's data bus is latched into IC1, a 74HC273 octal D-type flip-flop. When data is being written to the module, the DIRECTION (DIR) input of IC4, a 74HC245 octal three-state transceiver, is high, causing the direction of data flow to be from the A side to the B side. Note that the outputs of IC1 are connected to eight status LED's. Those provide instant checking of the status of each output (whether they are on or off) at a

- REC-CASE and PANEL/REC-OCTAL: Aluminum case assembly including front and rear panels; \$19.50.
- REC-KEY: 12-button keypad with scan-code decoding program; \$9.00
- VAC-PROG: vacation home-control program; free with SASE.
- Other REACTS products are available; contact DataBlocks directly for information and pricing.

Please include \$5.00 postage for any order of \$37.00 or less and \$10.00 postage for any order over \$37.00. Georgia residents must add appropriate sales tax.

glance. The outputs of the IC1 are also connected to IC6, a ULN2821 that contains eight Darlington drivers.

If the DC option is used, the devices to be controlled by the module are connected indirectly (via SO3) to the outputs of the Darlington-array package (ULN2821). The ULN2821 is a sink device, which basically means that the Darlington drivers turn on the device(s) being controlled by completing the electrical path to ground. When the Darlington pairs are turned off, the electrical circuit is opened (no path to ground), thus turning the device off. Each DC output will sink up to 130 mA at up to 95 volts. Higher current outputs are attainable by paralleling two or more outputs. To select the DC option, a jumper is placed in jumper location JU3 and all switches of S2 are closed.

The relay option uses IC6 to control the coil pull-in voltage of each relay. Each relay has normally open, normally closed, and center contacts. The +12 volts (pull-in voltage) needed to activate the relays can be provided by the REACTS system's power supply or an external source. If the system power supply is used, care should be taken not to exceed its maximum current ratings.

To select the relay option, a jumper is installed in location JU2 and all switches of S2 are opened. To select an external power source for the relays, a jumper is installed in location JU3; to use the system power supply as the relay power source, install a jumper in location JU1.

Because many process-control applications require instantaneous response, provisions have been made on the module for using one of seven (10 through 16) of the system's eight

maskable interrupt inputs. The system's maskable interrupts are prioritized; that is, interrupt 0 has precedence over interrupt 1, interrupt 1 has precedence over interrupt 2, etc. The interrupt input to be used by this month's module (if any) would depend on the importance of the task the module is performing as compared to tasks performed by other modules.

Construction and checkout

Building the octal I/O module is fairly simple. The main concerns are the installation and soldering of the two 60-pin bus connectors and making sure that the input and output terminal strips are correctly oriented. The available kits listed elsewhere in this article provide the quickest and simplest way of building the module. The kits come with all the necessary components, a silk-screened printed-circuit board, and complete construction and module operation in-

structions. For those who do not wish to go the kit route, a PC pattern will be provided next month in PC Service; the board should be built following the parts-placement diagram shown in Fig. 3.

After building the module, it must be tested. Before testing you must decide which of the system's I/O ports you want the module to occupy. When choosing an I/O port, do not choose any that are already in use by the CPU or any other module in your system. It is a good idea to keep an I/O-configuration log that lists all the I/O ports used by each module. That way, as new modules are added, you need only consult the I/O-configuration log to determine which of the I/O ports are unused.

If the module has been configured for the relay option, a simple test is to connect one lead of an ohmmeter to the center output of one of the relays and the other lead to the normally

open output of the same relay. With the relay open, the resistance reading should be infinite, and when the relay is closed, the ohmmeter should read zero. To close a relay, a logic 1 must be placed in the correct position of the byte output to the I/O port used by the module. For example, in the following BASIC program, the module is located at I/O port 24, and the relay to be closed is relay 2. The module is set to I/O port 24 by placing the fourth and fifth switches from the left on the modules I/O-addressing switches (S1) in the up position and the other six switches in the down position. Note that a 1 is at bit 2 of the byte being output to the module; that will cause relay 2 to close.

```
10 OUT 24, &X00000100
```

```
20 END
```

Note: The two characters, &X, preceding the binary number, 00000100, in the program tell the interpreter or compiler that the number is in binary form. The characters &X are used by the ZBASIC programming language; the syntax may differ with other BASIC programming languages.

Since the outputs of the DC option of the module are open-collector outputs, a resistor that will simulate a load must be connected between the external power supply and the output(s) being tested; see Fig. 4. When choosing a resistor for that purpose, remember that each DC output's maximum current-handling capability is 130 milliamps. Also, calculate the amount of power that must be dissipated by the load resistor and make sure the resistor's wattage rating will accommodate at least twice that.

For example, if the power supply is set to 12 volts DC and an 800-ohm resistor is used, the amount of current drawn will be approximately .015 amp, or 15 milliamps (12 volts divided by 800 ohms), which is well below the output's maximum current rating. Also the amount of power to be dissipated by the resistor is approximately 0.18 watts (.015 amps times 12 volts), so a resistor capable of dissipating at least 0.36 watts is needed.

After you have connected the external power supply and the resistor, (or load) to one of the DC outputs, connect the positive lead of a DC voltmeter to the DC output slot on the

continued on page 62

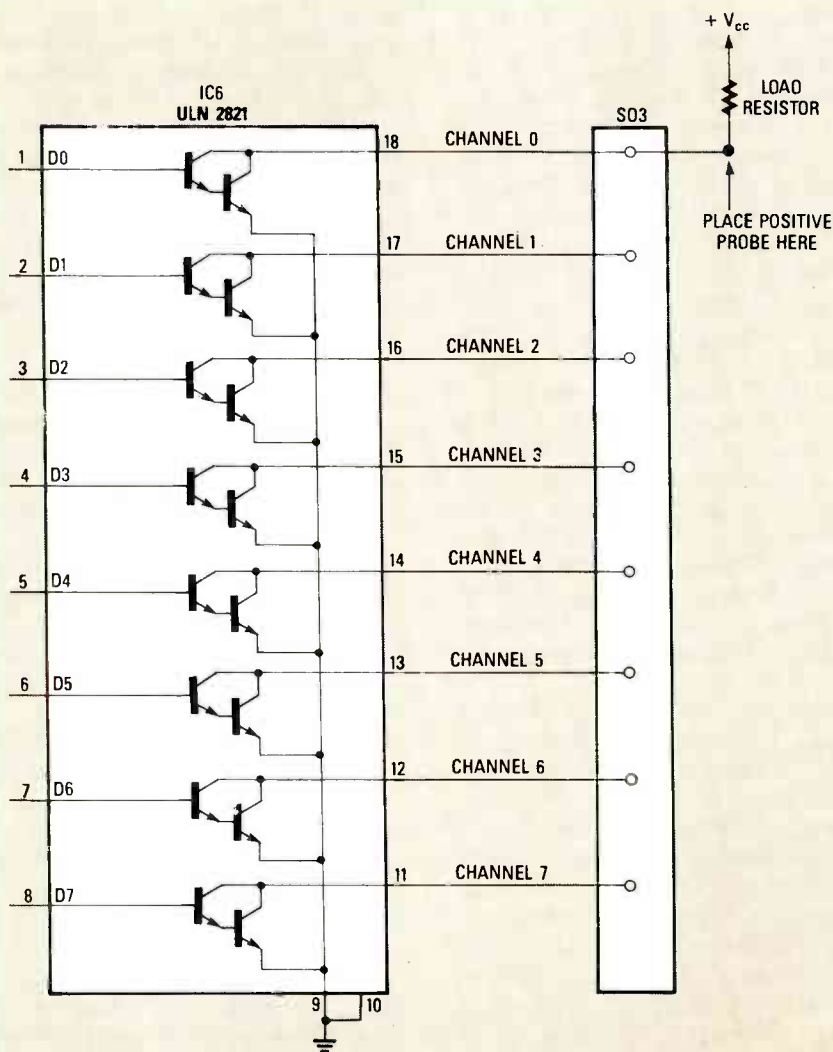
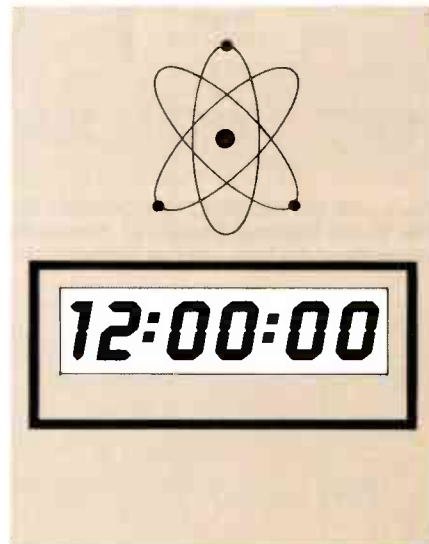
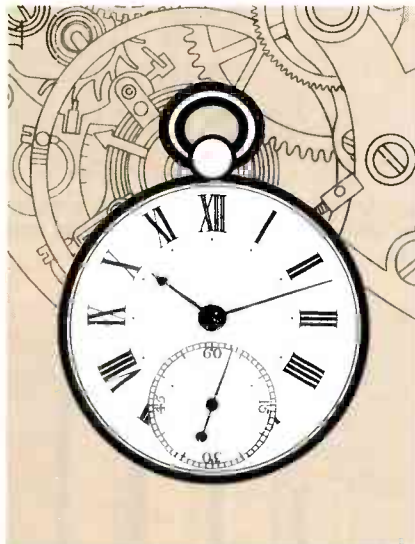
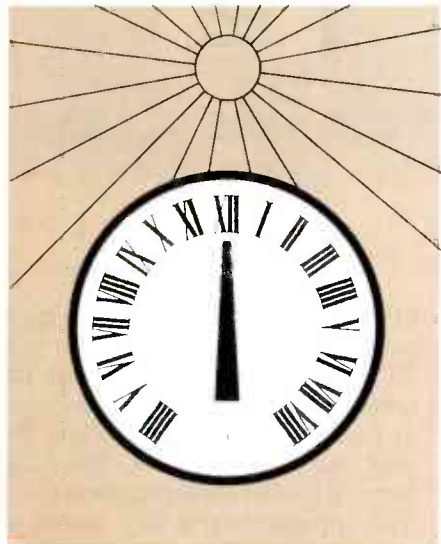

FIG. 4—THE DC OUTPUTS can be tested using the arrangement shown here.

ALL ABOUT

CALIBRATION



THE QUEST FOR PERFECT MEASUREMENTS



New accuracy standards for ohms, volts, amperes, and time itself.

VAUGHN D. MARTIN

ONE CAN IMAGINE PYTHAGORAS, THE Greek mathematician, sitting beside his sundial measuring the hours of the day. Despite his brilliance, could Pythagoras have envisioned a cesium atomic clock capable of splitting a second into a billion parts?

In today's world, how accurately can our modern instruments really measure the time, the volt, the ampere, and the ohm? New scientific instruments based on the physical constants of nature can now measure electrical quantities so accurately that, by comparison, those instruments make your best digital multimeter look like Pythagoras' old sundial.

Traceable standards

The cornerstone of our system of scientific measures is the International System of Units, which is officially abbreviated SI. Length, time,

mass, and temperature, are the SI units which represent the ultimate in physical standards, and are the basis for all lower levels of traceable measures. Those lower levels are the primary standards of the National Bureau of Standards; the NBS secondary standards which include transfer, check, and scaling standards; the NBS working standards, which are used to calibrate and certify local standards, and finally, inter-laboratory standards, local secondary standards, and tertiary-level standards. It is the bottom tertiary-level standards that are the ones we use for production work, quality control, maintenance, and general-measurement purposes.

Notice that the SI standards are the ultimate standards for the scientific communities of most industrialized nations. As shown in Fig. 1, all electrical standards are traceable to those

SI units. It's that traceability that gives us confidence in our bottom-rung tertiary standards.

In the hierarchy system of calibration standards, each step in the ladder costs you some degree of accuracy. As electronics products become more and more sophisticated, testing them requires instruments of increased accuracy. One way to obtain that accuracy is to eliminate some of the calibration hierarchical steps. However, it would be even better to eliminate the concept of calibration chains altogether. In fact that's what is being done today using *intrinsic standards*—those offer the possibility of a standard volt, ohm, farad, or whatever, that is equivalent to the NBS primary standard, right there in your lab.

According to the NBS, one definition of an intrinsic standard is a standard that relies on nothing but some

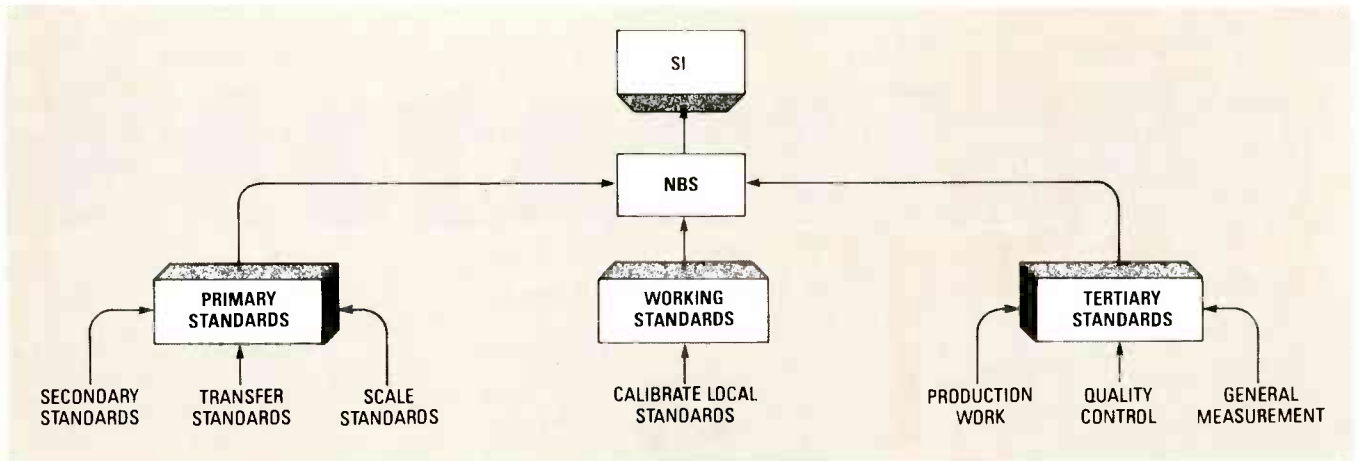

FIG. 1—AN INSTRUMENT IS CONSIDERED CALIBRATED only if its calibration is traceable to the National Bureau of Standards, and ultimately, to the physical units and constants of the International System of Units (SI).

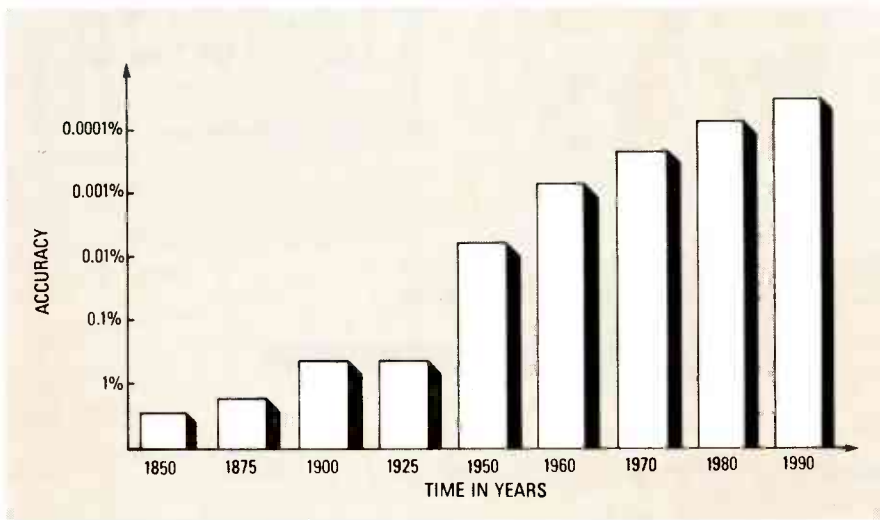

FIG. 2—THE IMPRESSIVE ADVANCES IN ACCURACY in measuring the volt. Experiments presently underway are expected to yield an increase in measurement accuracy of 9 parts-per-million in 1990.

very fundamental properties like the basic constants of nature, such as the speed of light, the elemental charge of an electron, Planck's constant, etc. The trend of thinking in terms of intrinsic standards is exemplified in the new NBS apparatus, and theories, that are used to increase the accuracy of measurement.

Figure 2 shows the impressive advances in accuracy in measuring the volt since 1850. The next leap in measurement accuracy for the volt, and ohm, will occur in 1990 when experiments presently underway will be completed.

Length and time standards

Let's start our discussion of calibration standards by considering two of the most fundamental of all measures, length (distance) and time. The basic unit of length is the meter. At

one time, the standard for the meter was defined as the length between two scratches on a platinum-iridium bar, and was originally calculated as one ten-millionth of the distance between the North Pole and the Equator, through Paris, France. The meter-bar now rests at the International Bureau of Weights and Measures, in Sèvres, outside Paris. It wasn't long ago that scientists would actually journey to Sèvres, from all over the globe, just to compare their meter stick with the standard platinum-iridium bar. Luckily for us, the meter has now been redefined as a certain number of wavelengths of an orange-red line of light irradiated by atoms of krypton⁸⁶. Hence, we now have an atomic standard for length that is reproducible by any lab with the proper equipment.

What about time? One of the earliest methods to keep time was proba-

bly *apparent solar time*, which measures a complete sun cycle as a 24-hour day. The device used for timekeeping was the sundial. As good as that system was for dividing the year into months, weeks, days, and hours, it could not keep uniform time. The apparent solar day varies in length for several reasons: the planetary orbit around the sun is non-circular causing the planet to speed up when closer to the sun, and slow down when farther away; Earth's orbital plane does not coincide with the plane of the equator; and lastly, Earth's spinning rotation is not uniform. Consequently, apparent solar time is unsatisfactory for most calibration purposes.

Early astronomers understood the laws of motion, and were able to correct the apparent solar time to a more uniform *mean solar time*. That compensated for Earth's elliptical orbit around the sun, and for the 23-degree 27-minute tilt from its orbital plane. Yet, those same early astronomers could do nothing to compensate for the non-uniform planetary rotation. Consequently, mean solar time is also too inaccurate for modern-day calibration purposes.

If you figure the mathematical corrections for Earth's elliptical orbit, and tilt, at the Greenwich meridian in England, then you would have *universal time*. It is flawed for the same reason as mean solar time; that is, Earth's spinning rotation about its axis is not uniform.

As clocks with improved accuracy were developed, scientists noticed that universal time measured at different locations around the world

yielded unequal results. The discrepancy between times was identified as being caused by a wobble in the planet's axis. The wobble is caused by the spinning rotation that makes the earth behave like a gigantic gyroscope. When universal time UTO is corrected to compensate for that wobble (polar motion), then UTO becomes UT1. After being corrected for seasonal variations in the rate of rotation, UT1 is designated UT2.

Apparent sidereal time is used for many astronomical applications because its scale is keyed to the relative position of Earth to the stars, rather than to the sun. The fact that the earth's orbit around the sun is elliptical, and not circular, becomes unimportant when measurements are derived from distant stars. A sidereal day is about 23-hours and 56-minutes in terms of mean solar time.

Ephemeris time is based on orbital movements of Earth, the moon, and the other planetary bodies. In effect, ephemeris time places celestial bodies in repeatable astronomical relationships, year after year. It was important because it fulfilled the requirements for a non-varying unit of time.

As a general rule, universal time (UT0, UT1, UT2) is accurate to within

3 ms in 1 day. Ephemeris time is accurate to within 50 ms in 9 years. And finally, atomic time is accurate to much less than 0.1 μ s in 1 minute. You can now understand why scientists are so excited about atomic time as a means to maintain accurate time and frequency standards.

Atomic time

So far we've discussed various methods of keeping time based on the 24-hour cycle of Earth's rotation; cor-

relating that rotation to the movement of Earth with respect to either the sun, or far-away stars. Until 1967, the second was defined as 1/86,400 of a duration of a single planetary rotation. But that rotation rate is slowing by about one second every 10 years.

The second itself had to be re-defined. Instead of using the cyclic rotation of Earth as a starting point, atomic clocks maintain accurate time by counting frequency cycles of a signal that is locked to some atomic resonance. The *international atomic time*, which is termed TAI, was adopted in 1971 by the General Conference of Weights and Measures, and is based on a non-variant transition in the cesium atom. Under TAI, the second is now equal to 9,192,631,770 periods of electromagnetic radiation emitted by that transition. The fractional frequency stability of the emitted radiation is about 1 part-per 100 billion. Some of the better atomic clocks are accurate to less than a few billionths of a second in a minute.

In general, atomic-time standards make use of an atomic resonance device to phase-lock a frequency source, such as a voltage-controlled crystal oscillator. Atomic resonators are classified as either passive or active. Examples of passive resonators include cesium-beam tubes, and rubidium-vapor gas cells. Active resonators include hydrogen masers.

An actual cesium-beam frequency standard, manufactured by Hewlett Packard, model 5061B is shown in Fig. 3. A functional diagram of the cesium standard is shown in Fig. 4. A microwave field is derived from a

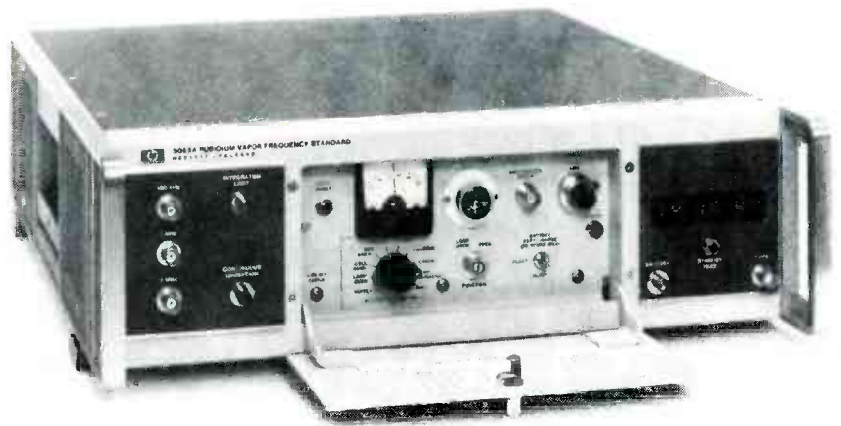

FIG. 5—A RUBIDIUM-VAPOR FREQUENCY STANDARD. This device is manufactured by Hewlett Packard.



FIG. 3—A CESIUM-BEAM FREQUENCY STANDARD. This device is manufactured by Hewlett Packard.

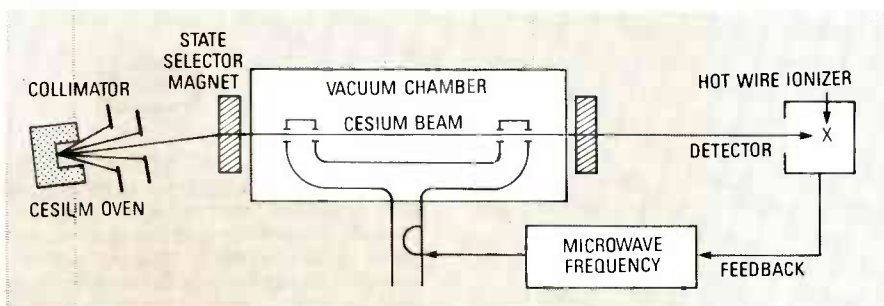

FIG. 4—FUNCTIONAL DIAGRAM of a Cesium Beam Standard.

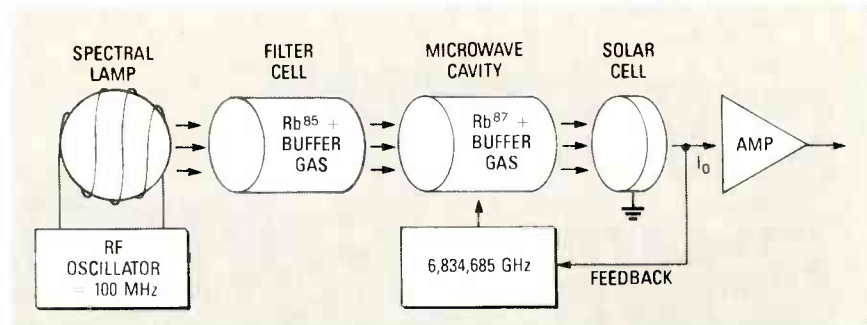

FIG. 6—FUNCTIONAL DIAGRAM of a Rubidium Frequency Standard.

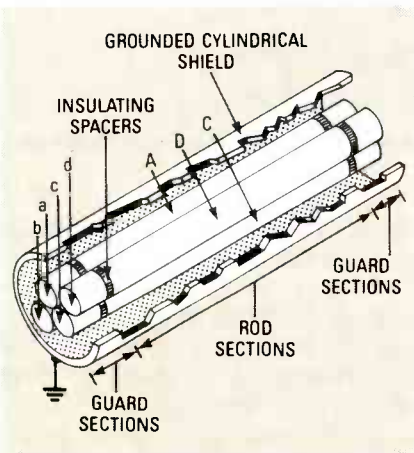

FIG. 7—FIRST OPERATING CALCULABLE CROSS-CAPACITOR built by NBS in 1960.

quartz oscillator by frequency multiplication and synthesis, and is phase-modulated at an audio rate. When the microwave frequency begins to deviate from the center of atomic resonance, the output current from the cesium tube contains a component alternating at the modulation rate. The amplitude of that component is proportional to the frequency deviation, and also contains phase information on the direction of deviation. After further filtering and amplification, that component is used to provide a DC voltage to automatically fine-tune the quartz oscillator to zero error.

An actual rubidium-vapor frequency standard, manufactured by Hewlett Packard, model 5065A is shown in Fig. 5. The functional diagram of the rubidium standard is shown in Fig. 6. The rubidium standard uses a filter comprised of rubidium⁸⁵ gas vapor, and an inert buffer. That filter will reduce the possible effects of Doppler shift on frequency. In conjunction with a solar cell illuminated by a beam of filtered light, a microwave cavity (filled with rubidium⁸⁷ gas) monitors changes near resonance as a function of the

amount of light absorbed with respect to applied microwave energy. That microwave signal is derived by multiplying the quartz-oscillator frequency. A feedback loop connects the detector output and oscillator, so that the oscillator is locked to the resonance frequency. A rubidium frequency standard costs about \$12,000, while the cesium frequency standard costs about \$36,000.

Lastly, WWV radio broadcasts of time are based on the coordinated universal time scale, identified as UTC. Since January 1, 1972, UTC has accumulated time at the same rate as atomic time with occasional one-second adjustments to keep synchronism with UT1. Hence, on a second-by-second basis, UTC is really an atomic rather than an astronomical standard. The UTC time scale meets the needs of most users. Somewhat surprisingly, however, in applications where very precise navigation is required, then a time scale that speeds up, and slows down, coincident with Earth's rotation rate must be used. That particular time scale uses UT1, and is inferred from astronomical observations of stars and planets.

Now let's move away from measurement and calibration of time standards (length, time, mass, and temperature) to other measurements used principally in electronics. Those are the farad, the henry, the ampere, the ohm, and the volt.

Electrical standards

The National Bureau of Standards uses the four SI units of physical standards (length, time, mass, and temperature) from which all other electrical measures can be derived mathematically; they include voltage, resistance, capacitance, inductance, frequency, time, etc. Nobel prizes have been awarded to scientists for developing laboratory methods, de-

veloping physical constants and theoretical models, and using those independent units in determining the exactness of an electrical measure.

During the late 19th century, Maxwell demonstrated that there is a relationship between the speed of light, and the product of the permeability and the permittivity of free space. Expressed as a formula, Maxwell's equation is:

$$1/c^2 = \mu_0 \epsilon_0$$

Because we know the speed of light in free space c , we can select either permeability μ_0 , or permittivity ϵ_0 , experimentally derive a value for one, and solve for the unknown. That brings us to the threshold of our first electrical standard.

The farad

In 1956, Thompson and Lampard of the Australian National Measurements Laboratory published a theorem based on electrostatics to construct a calculable cross-capacitor, shown in Fig. 7, from which an absolute farad could be derived. The capacitance can be calculated to a very high degree of accuracy from knowing the distance between the

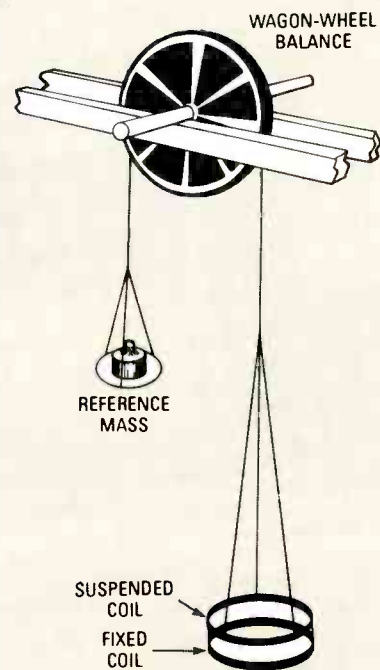

FIG. 8—THE NBS FORCE BALANCE, just like a scale measuring equal weights of gold and silver, measures an exact ampere of current by comparing electric, and gravitational forces. In this current balance, the attractive force between two current carrying coils is balanced by a gravitational attraction on a known mass.

cross-capacitor rods, and the permittivity of a vacuum. Using the equation for permittivity:

$$\epsilon_0 = 1/\mu_0 c^2$$

both μ_0 , and c , are exactly known constants, then permittivity ϵ_0 is also exactly known.

In 1974 the NBS derived the farad to within 0.02 parts-per-million using that cross-capacitor model. As shown in Fig. 7, a set of precisely measured parallel rod sections are surrounded by a grounded cylindrical shield. The calculated cross-capacitance is the average capacitance per meter of length, of the capacitor formed by rods A and C, and those formed by rods B and D. When the guard section a, is kept at the same voltage as A, b at the same voltage as B, etc., then the rod sections act as if they are infinitely long.

After deriving the farad, the other electrical measurements fell into place. A Wheatstone-type bridge was used to balance a resistance in terms of a capacitance. That experiment established a calibrated measure for both a farad, and an ohm. The standard for the henry, the unit of inductance, was derived by applying the principle that impedance to the flow of alternating current is minimum in a series-tuned or resonant LC circuit. And if the capacitance is well defined, the inductance can be derived with equal precision.

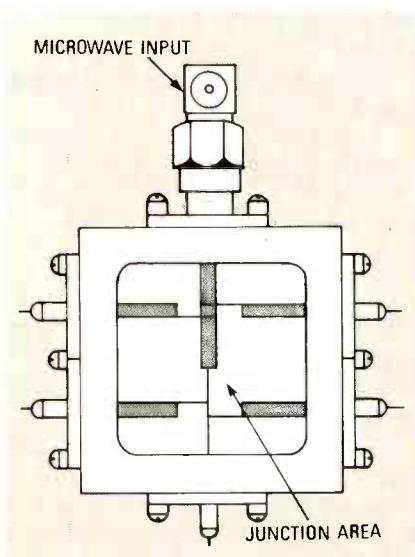

FIG. 9—THIS JOSEPHSON MICROSTRIPLINE JUNCTION is mounted in a metal enclosure. It is kept in a supercooled environment enabling the Josephson junction to yield a very precise frequency-to-voltage transformation.

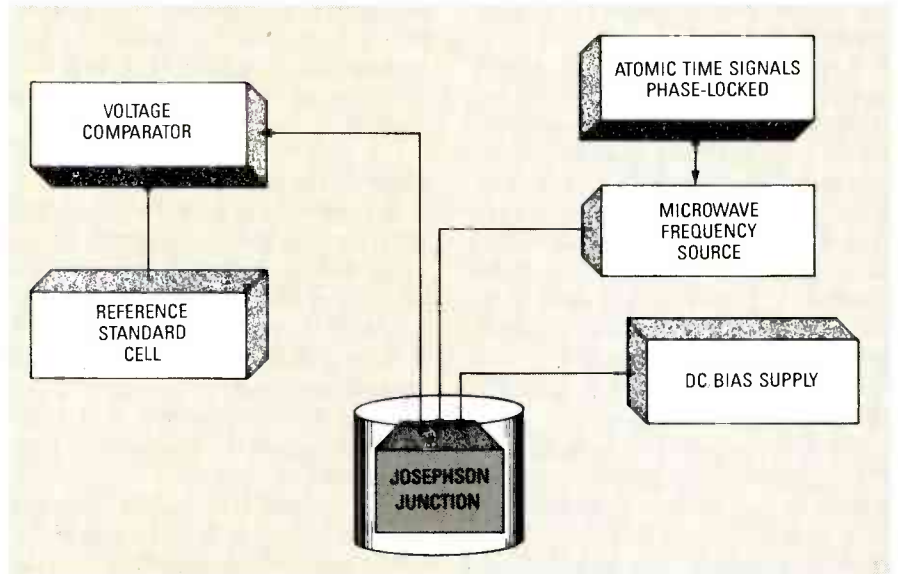

FIG. 10—BLOCK DIAGRAM OF A VOLTAGE STANDARD system using an AC Josephson junction reference to calibrate NBS standard cells.

The NBS used Ampere's equation to derive current in terms of magnetic force. The SI defines the ampere as that constant current which, if maintained in two straight parallel conductors of infinite length, placed one meter apart in a vacuum, would produce a magnetic force equal to 2×10^{-7} Newton per meter of length. That implies that the magnetic permeability of a vacuum μ_0 is an exact constant. A practical NBS device used to measure an ampere is the current balance, which is shown in Fig. 8. In the current balance, the force between two current carrying coils is matched by the gravitational attraction on a known mass.

Since 1930, the NBS standard for resistance, the ohm, has depended on a set of 10 standard wire-wound resistors. In 1980, Klaus von Klitzing, a German researcher, showed that a resistance called the Hall Resistance:

$$R_{\text{Hall}} = h/e^2$$

generated by a current flowing in a semiconductor, could be calculated in terms of the square of the charge of an electron e , and Planck's constant h . For his experiments on the *Quantized Hall Effect*, he won the 1985 Nobel Prize for physics.

By 1983, NBS researchers and other specialists had developed a intrinsic standard for resistance. The quantized Hall effect had been developed to a sufficient degree that it could be used to check the stability of NBS wire-wound resistor standard; that eliminated a drift of 5 parts-

per-100 million per year in the value of the NBS resistor standard.

The volt

The last electrical unit we'll review, the volt, is the most interesting. Until recently, NBS measured the volt by the voltage drop across one ohm produced by one ampere. Through the early 1970's, the commonly agreed-on representation of the volt was tied to the voltage of a *Weston Cell*; a wet-cell battery with a cadmium-sulphate electrolyte that generates a very stable voltage of slightly more than a volt. But even a carefully controlled Weston cell drifted over time. The NBS now uses a better device, shown in Fig. 9, which resulted from work done in 1962 by the Nobel-Prize-winning British physicist, Brian Josephson, who demonstrated what has become known as the *AC Josephson Effect*. The Josephson junction is a microwave frequency-to-voltage converter with a ratio:

$$f\text{GHz/V} = 2e/h$$

exactly equal to two times the elementary charge of an electron e , divided by Planck's Constant h .

A value for the Josephson ratio commonly used is:

$$483,594 \text{ GHz/V} = 2e/h$$

which is known to be about 8 ppm less than the SI value. Presently, there is a debate on adapting a new value for the Josephson frequency-voltage ratio, $2e/h$, and the Hall resistance ratio, h/e^2 , that would be both consistent with

the SI, and that would be universally accepted.

Approximately every 10 years, physicists around the world get together to adjust the fundamental constants, such as the charge on an electron, the mass of a proton, and Plank's constant. Those changes reflect improved measuring techniques, and new ways of measuring those quantities. The constants relating to the volt and the ohm, will be readjusted in 1990. The cutoff date for values of $2e/h$, and h/e^2 is June 15, 1988.

To produce an exact voltage, the NBS places a Josephson junction, shown in Fig. 10, in an environment near absolute zero (-273.15°C). At that temperature, the junction behaves like two superconductors separated by a thin nonconducting film. The junction is then irradiated with microwaves from a klystron tube that is phase-locked to NBS WWVB atomic time signals, while a stable DC current source is used for bias. The DC bias current is increased at a constant rate until a critical value is reached. The voltage output from the Josephson junction is zero until the critical DC bias current, at which point, the voltage output will jump to a specific value ΔV dependent on the microwave frequency. If the DC bias current is increased to a slightly greater value, the junction voltage will jump to $2\Delta V$, and so on, each voltage jump in perfectly equal ΔV steps. At the point where the ΔV voltage is at the correct level, it is then interfaced to an external voltage comparator, which uses an NBS standard cell as a reference.

The Josephson junction produces a DC voltage of between 1 mV and 10 mV depending on the injected microwave frequency. If we remember that the microwave frequency is phase-locked to atomic time, then we have a highly repeatable and accurate method that produces a DC voltage approaching the accuracy of the atomic-time standard. Furthermore, that is a portable system, limited only by reception of WWVB, or equivalent time signals. In 1984, NBS researchers and the West German National Standards laboratory have developed ways to link-up about 1,500 Josephson junctions on a single integrated circuit to produce a reliable 1-volt standard. And in 1985, a NBS researcher integrated an array of 2076

junctions that can be tuned up to more than 2 volts. The feasibility of commercial manufacture of Josephson junction arrays is presently being studied.

Real world calibrators

We have come a long way in electrical measurements during the last 40 years, from volt-ohm meters with accuracies of 3% to 10% to modern digital voltmeters with accuracies of 0.001%. That 10,000-fold increase in measurement accuracy was mainly fostered by both military and aerospace demands for instruments having greater accuracy.

You will find real-world calibrators divided into two broad categories. Those are passive and active. A passive instrument requires no external power source, contains no signal amplification circuitry, and will generally yield greater accuracy than active ones. An example of a passive instrument is a decade resistor box. An example of an active instrument is a digital voltmeter. You will find passive instruments providing most NBS primary standards, with tertiary standards typically being provided by active instruments.

Because the SI definitions of the volt, ohm, and ampere are difficult to realize in practice, the NBS laboratories have historically used practical representations of them based on artifacts to act as primary standards. For example, the electrochemical standard Weston cell (1.018 volts) may serve to define the laboratory voltage standard. Similarly, a group of precision wire-wound resistors (1 ohm) may serve to define the laboratory standard of resistance. The laboratory unit of current (1 ampere) is defined in terms of a lab volt, and a lab ohm. Unlike the ohm (wire-round resistor), or the volt (Weston voltage cell), the ampere does not have its own artifact that you can carry from one place to another.

If the primary standards are maintained by artifacts, what maintains their accuracy over time? The answer is intrinsic standards. Most national laboratories now use the AC Josephson effect in superconductors to maintain their unit of voltage. While not yet in as wide use as the Josephson effect, the quantum Hall effect promises to do for resistance what the Josephson effect has done for voltage. R-E

REACTS

continued from page 56

terminal strip. Then connect the ground lead of the voltmeter to the ground slot of the terminal strip. When the DC output being tested is turned off, the voltmeter should read approximately the same voltage as is being supplied by the power supply. When the output is turned on, the voltmeter should read from 0.7 to 1.1 volts. Earlier, we noted that the DC outputs are sink devices that complete the connection to ground to turn the load being controlled on. Since the devices are transistor arrays, there will still be a small voltage drop across them when they are turned on.

When testing the input portion of the module, keep in mind that all the inputs are pulled high. With none of the inputs connected to anything, an input from the module should result in a binary reading of 11111111 (all inputs high). With channel 0 grounded, an input from the module should result in a binary reading of 11111110 (channel 0 is low). Unground channel 0 and ground channel 1, and an input from the module should result in a reading of 11111101 (channel 1 is low). Proceed with that method and test each channel. The following BASIC program can be used to perform the test:

```
10 REM MODULE IS AD-  
DRESSED AT I/O PORT 24
```

```
20 REM IP = INPUT FROM  
MODULE
```

```
30 IP = INP(24)
```

```
40 PRINT BIN$(IP)
```

```
50 END
```

Note: Statement 40 tells the CPU to display the input data in binary form. The syntax may vary between different versions of BASIC.

That's all we have space for this month. Next time we'll take a look at some applications. Among them will be a digitally controlled combination lock that will reliably protect your home. We'll also show you how to control household appliances. For example, you'll be able to automatically turn your lights on and off for a lived-in appearance. R-E

PC SERVICE

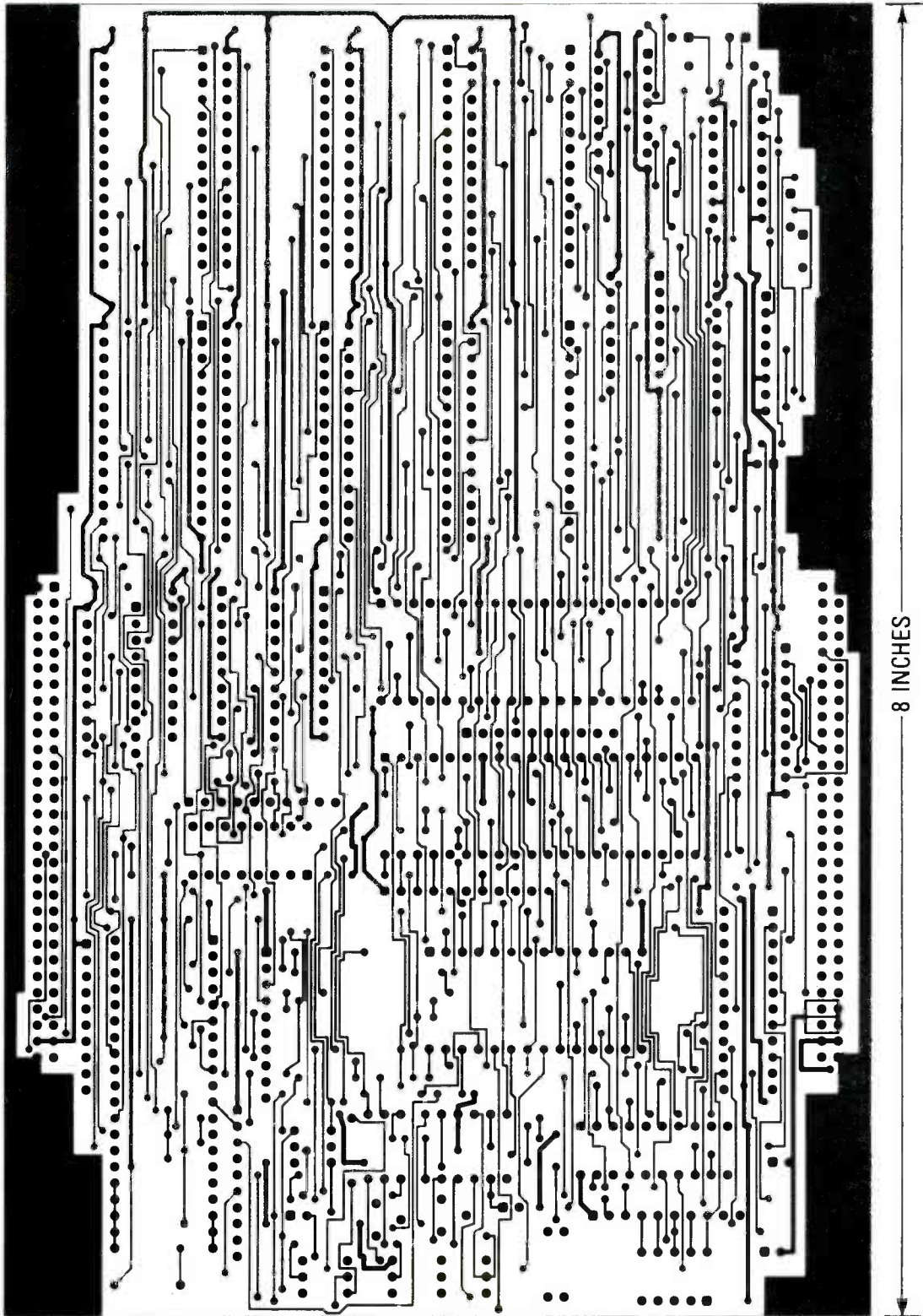

THE REACTS PROM/RAM DISK BOARD. The solder side of last month's board is shown here right reading and full size. The patterns for the REACTS I/O board will be shown next time when we discuss applications using it.

PC SERVICE

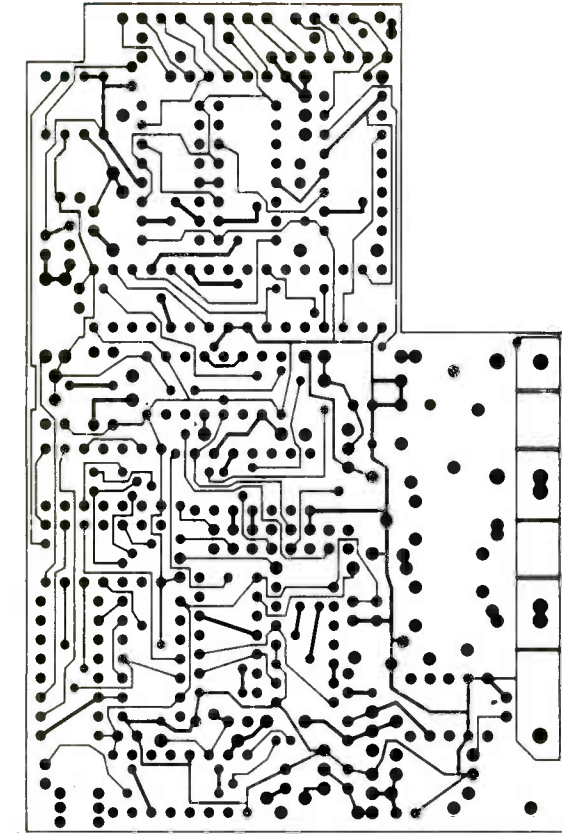

4 5/16 INCHES

THE RADALERT main board component side.

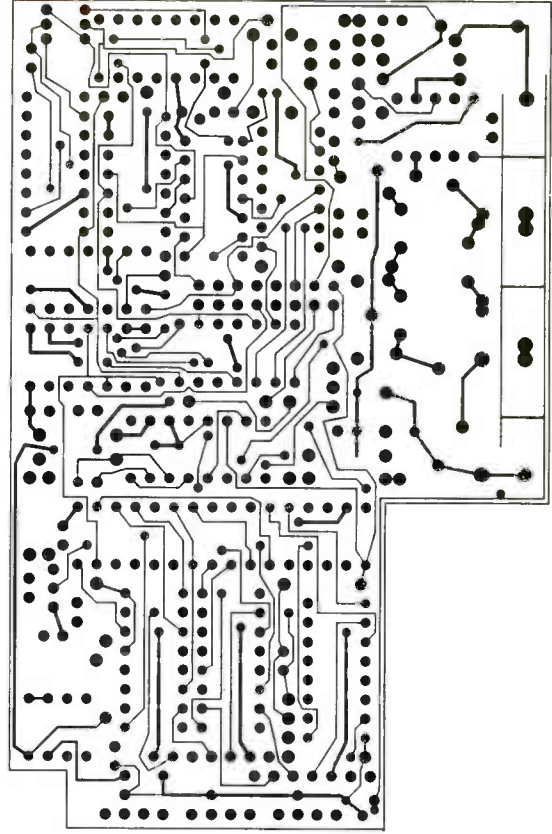

4 5/16 INCHES

THE SOLDER SIDE of the main board.

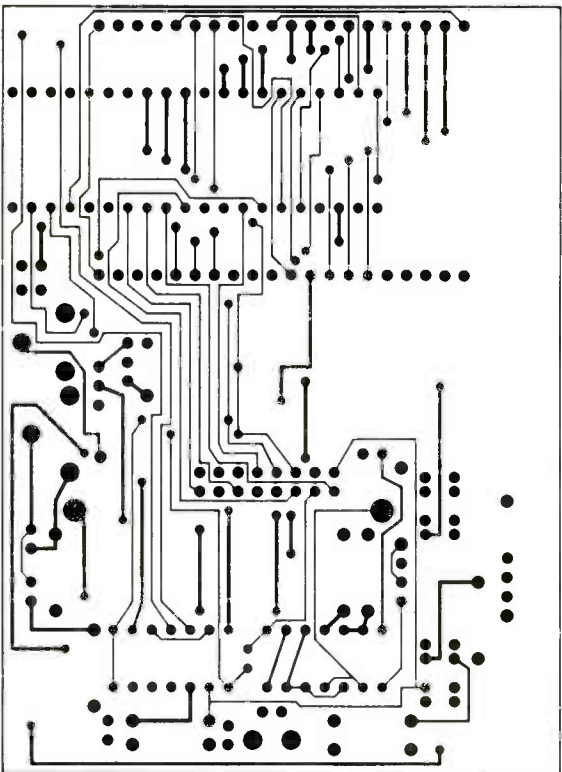

4 INCHES

COMPONENT SIDE for the Radalert's display/beeper board.

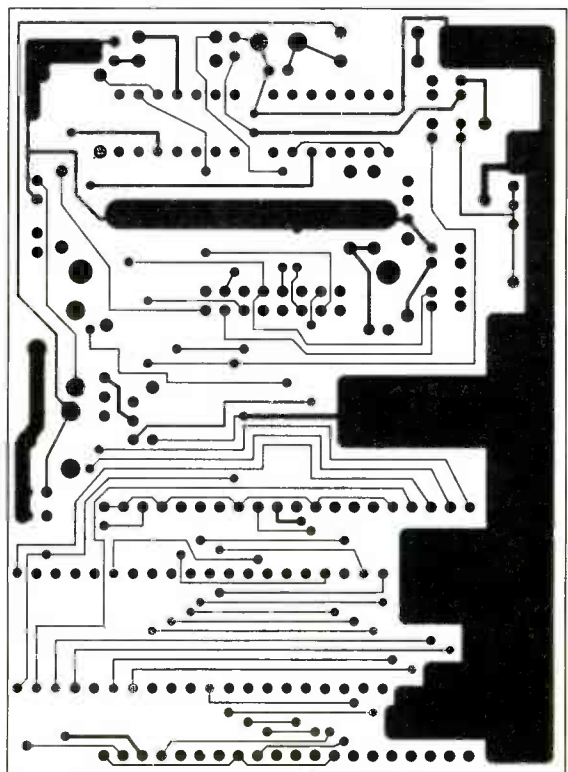

4 INCHES

SOLDER SIDE for the display/beeper board.

HARDWARE HACKER

Finding parts sources
RS-232 serial interface
Perspective Transforms
More on superconductors
Computer memory expansion

Finding parts, computer communications, and more! DON LANCASTER

THERE SEEM TO BE A LOT OF BRAND NEW sources for hacker superconducting samples and materials. Several of those are ridiculously overpriced, while others are becoming real bargains.

The \$8 superconducting sample from Laboratory Specialists would appear to be the low-cost winner, but there's also a \$25 package now available through National Superconductor that gives you a much larger and more stable sample with pre-attached leads, along with the necessary super-strength magnet.

Two of the higher-priced superconductor sources include Edmund Scientific and Fluoramics.

We will put our usual reminder here that this is your column and you can get technical help per the "Need Help" box. Also, please note the "Names and Numbers" section that shows you where to go for more tech information on all of the products mentioned.

Let's start off with....

Getting component parts

Getting small quantities of sanely priced electronics and

NEED HELP?

Phone or write your **Hardware Hacker** questions directly to:
Don Lancaster
Synergetics
Box 809
Thatcher, AZ 85552
(602) 428-4073

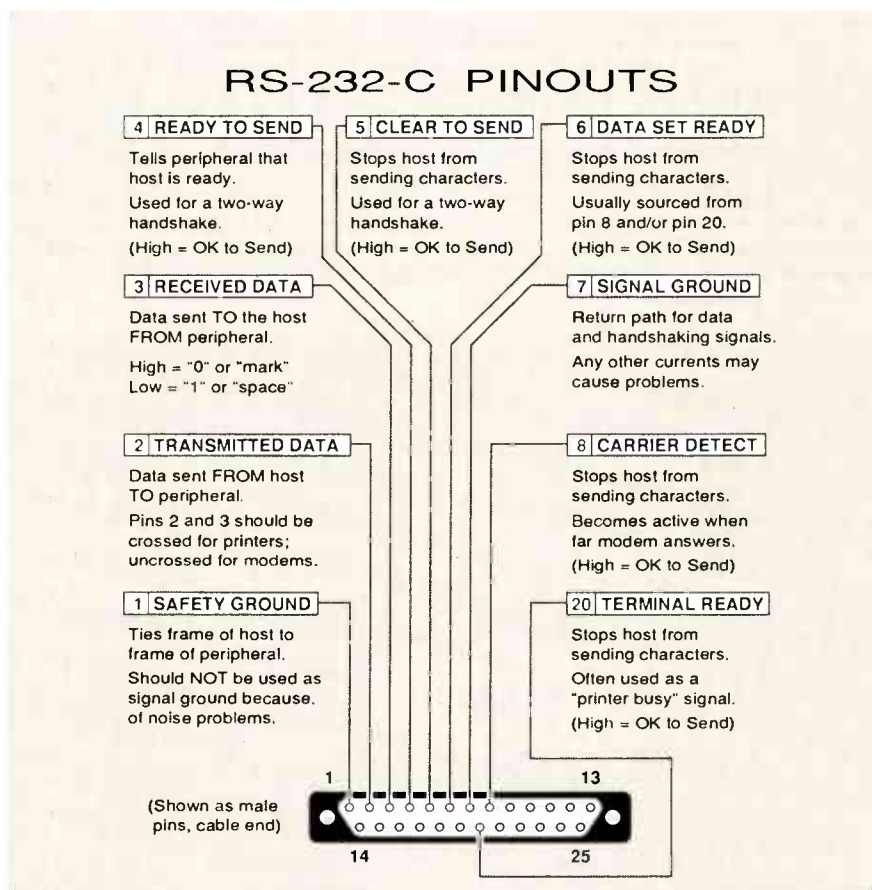

FIG. 1—HERE ARE SOME DETAILS on the RS-232 serial communications standard. Note that the data and handshake lines are often crossed for printers and uncrossed for modems.

other hacker components can be both a major challenge and a real hassle. On the other hand, the last help-line caller was someone who just had "looked everywhere for weeks" and could not find a 500K volume control in downtown Boston.

Rule number one of component gathering is to tune yourself in ahead of time to the sources and

places where those parts can be found. And rule number two is that the bigger a hurry you are in, the less likely you will be to get the parts in the needed time frame.

Naturally, we would hope you would begin with our many fine **Radio-Electronics** advertisers. All of those people have gone out of their way to provide small-quantity components at reasonable prices.

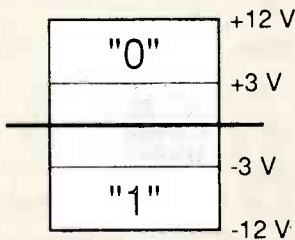

FIG. 2—HERE ARE the two logic levels that are needed for RS-232 communications. Note that a “negative-logic” convention is used.

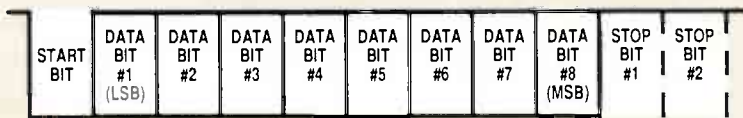

FIG. 3—MOST RS-232 SERIAL COMMUNICATIONS use this older “teletype” asynchronous code. Seven or eight data bits are normally used, with the least-significant bit always sent first. Any number of stop bits above the minimum can be sent between successive characters.

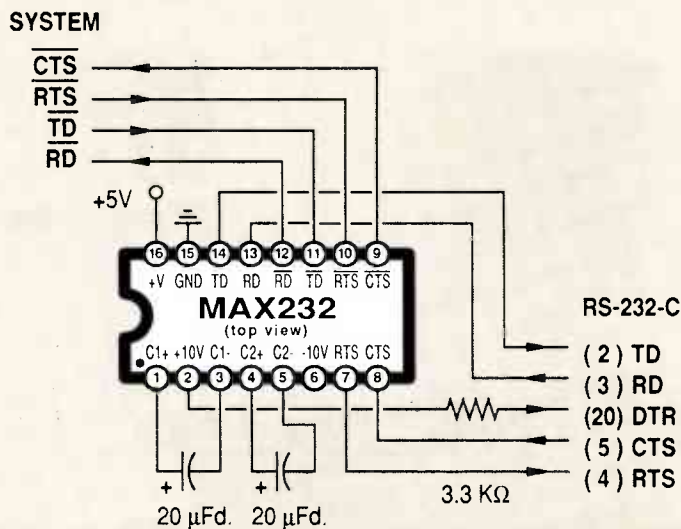

FIG. 4—THIS RS-232 DRIVER CIRCUIT needs only a single +5-volt supply. An internal charge-pump circuit generates the needed +10 and -10 volts for the actual interface levels.

That is often far and away your best source on any particular project, since substitutions can lead to all sorts of subtle to major problems.

Another obvious hacker parts source is a Radio Shack store. Their component selection is admittedly limited, particularly in the smaller stores. But they sure are handy.

Electronics distributors are your usual source for most components in smaller quantities. You will find several different types of those distributors, each one of which has strengths in certain

Old-line distributors stock nearly everything by practically everybody and can get most anything else on a backorder basis, however obscure. But they do have steep minimum orders, longer delivery times, and higher prices. Not to mention a distinct anti-hacker bias. Some old-line distributors are Newark, Schweber, Allied, Hamilton, and Cramer.

We saw last month how there is a separate distribution channel for the repair and replacement semiconductors and parts, with ECG and NTE being two of the leading sources here.

Surplus and distress houses are other major parts sources. Those feature extremely low prices on a catch-as-catch-can basis. But, the quality can range from first rate clear on down to floor sweepings. Besides the usual ads, you'll find those outfits in the Yellow Pages of most any city that has a “radio row” area. Local amateur-radio operators are also a good source of surplus-house locations.

Two of my very favorite surplus houses are Jerryco and Fair Radio Sales. The surplus price leader has to be BNF, but here you “buy your ticket and you take your chance.”

If you need larger quantities of quality mainstream parts in a hurry, the distress merchandisers that advertise in the classified section of *Electronic News* should not be overlooked. A typical price and quantity might be 2000 light-emitting diodes at three cents each.

Far and away the most important sources for info on all of the new components are the electronics trade journals. Those include *EDN*, *Electronic Design*, *E.E. Times*, *Electronic Products*, and *Electronics*, among others. Many of those are free if you request a subscription on a suitable business letterhead.

The coupons and bingo cards in those trade journals will then lead you to the actual data books, price lists, and application notes from all of their advertisers.

A nearly complete listing of all of the trade journals is available in *Uhlrichs Periodicals Dictionary* at your local library.

Many of the trade journals also publish annual directories. Three of the most useful and most impor-

And nobody has ever gotten filthy rich selling single quantities of 555 timers to electronics hackers.

We have given you a free “bingo” (free information) card—so use it!

Arrangements are sometimes made by the author of a project to provide all the key components.

areas. It pays to get familiar with all of them.

New-age distributors are outfits like Mouser, Jameco, and Digi-Key. Those people offer small quantities, reasonable prices, and low minimums. On the debit side, they only stock stuff that is likely to move.

tant are the *Electronic Design Gold Book*, the *EBC Electronics Buyers Guide*, and the *EEM Master*.

Computer Shopper magazine is far and away your best source for extensive listings of any computer-related components.

Some of the electronics houses are liberal with one or two free samples, while others are not. You will get the best results with a professional and specific request, written on a business letterhead, and clearly stating the intended application.

If a part seems ridiculously hard to find, that may be telling you something. One help-line caller has been on at least a dozen times, trying to find some cheaper substitute for a standard, legal, and type approved \$5 modem transformer. Another is still trying to find some tunnel diodes for a construction project he found in a 1960 Australian magazine article.

Finally, there is always networking. Ask somebody for help. Such as our help line, a local ham-radio operator, an engineer or tech at an electronics firm, a magazine author or editor, a computer or radio club, or an on-line BBS system.

Understanding RS-232

It should have been flushed years ago, with all its ridiculous connectors, its very limited range, its unworkable supply voltages, its user confusion, and its refusal to network. But, like it or not, the old RS-232 serial data-communications standard is still with us, and is only starting to be replaced by the very newest of systems.

Figure 1 shows you the RS-232 standard. A big DB25 connector is normally used, with female on the machines and male on the cables. The logic levels are as shown in Fig. 2, with a digital 0 being a positive voltage from +3 to +12, and a digital 1 being a negative voltage from -3 to -12.

While there are several ways to use RS-232 serial communications, the most popular is to use the old asynchronous teletype code shown in Fig. 3. By asynchronous, we simply mean that any amount of time at all can elapse between any successive transmissions.

A character or a word is transmitted by using a start bit, some

NAMES AND NUMBERS	
Allied Electronics 401 East 8th Street Ft. Worth, TX 76102 (412) 782-1624	Jerryco 601 Linden Place Evanston, IL 60202 (312) 475-8440
Advanced Micro Devices 901 Thompson Place Sunnyvale, CA 94086 (408) 732-2400	Laboratory Specialists 2085 Dahlia Denver, CO 80207 (303) 322-2120
BNF Enterprises 119 Foster Street Peabody, MA 01961 (617) 531-5774	Maxim 510 Pastoria Avenue Sunnyvale, CA 94086 (408) 737-7600
Computer Shopper Box F Titusville, FL 32781 (305) 269-3211	Mitsubishi 1050 E. Arques Avenue Sunnyvale, CA 94086 (408) 730-5900
Cramer 17201 Daimier Street Irvine, CA 92714 (714) 979-3000	Mouser Electronics Box 9003 Lakeside, CA 92040 (619) 449-2222
Digi-Key 701 Brooks Avenue South Thief River Falls, MN 56701 (800) 344-4539	National Superconductor 13968 Van Ness Avenue Gardena, CA 90249 (213) 323-3923
Edmund Scientific 4128 Edscorp Building Barrington, NJ 08007 (609) 573-6250	Newark Electronics 228 East Lake Street Chicago, IL 60640 (312) 941-7200
Fair Radio Sales 1016 E. Eureka Street Lima, OH 45802 (419) 227-6573	Siliconix 2201 Laurelwood Road Santa Clara, CA 95054 (408) 744-1500
Fluoramics, Inc 103 Pleasant Avenue Upper Saddle River, NJ 07458 (800) 922-0075	Small Parts 6901 NE Third Ave Miami, FL 33238 (305) 751-0856
Hygenic Manufacturing 1245 Home Avenue Akron, OH 44310 (216) 633-8460	Synergetics Box 809 Thatcher, AZ 95552 (602) 428-4073
Jameco Electronics 1355 Shoreway Road Belmont, CA 94002 (415) 592-8097	Xicor 851 Buckeye Court Milpitas, CA 95035 (408) 946-6920

number of data bits starting with the least significant, an optional parity bit, and some number of stop bits. One fairly popular text character format is to use seven data bits, no parity, along with two ending stop bits.

The rate at which the bits go over the interface is set by the bit rate, which is also popularly called the

baud rate. Current baud rates include 110, 300, 1200, and 9600. It is of utmost importance that both ends of the system always are using the exact same baud rate, number of data bits, type of parity, and number of stop bits.

To further confuse you, there are two styles of RS-232 transmission. With DCE or "modem" com-

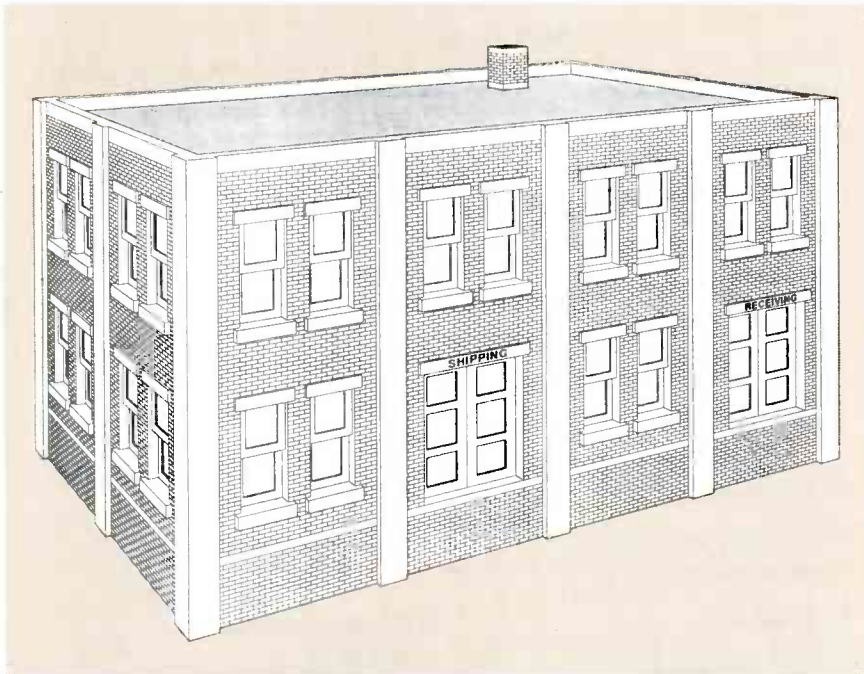

FIG. 5—A TWO-POINT PERSPECTIVE DRAWING is easily handled by using your favorite word processor and a PostScript printer. The lettering is also drawn in true perspective, as are each of the 4783 bricks. The text file for this drawing is only 3K long!

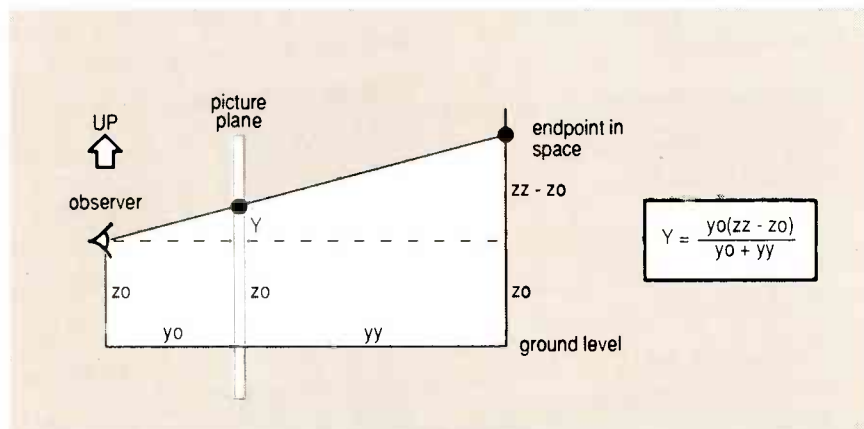

FIG. 6—THE VERTICAL MATH TRANSFORM that is required for two-point perspective. That calculation gets done at the end point of each line and is trivial for most any computer.

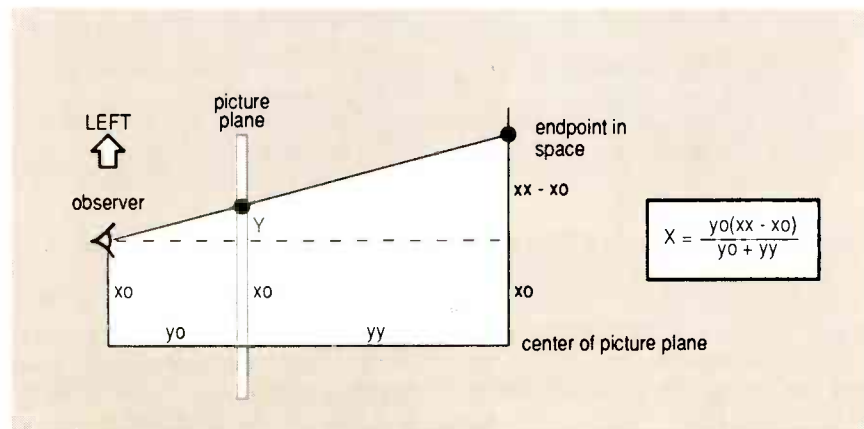

FIG. 7—THE HORIZONTAL MATH TRANSFORM that is required for two-point perspective is similar to the vertical one, except that you are now going left and right, rather than up and down.

munications, there are no data or other pin crossings, and a "straight" cable that routes pin 2 to 2, 3 to 3, etc. is most often used.

With DTE or "printer" communications, a "crossed" cable is used that crosses pins 2 and 3, 3 and 2, 4 and 5, 5 and 4, 6 and 20 and 20 and 6. That crossing is sometimes called a modem eliminator.

There are several different types of handshaking used with RS-232. When using a hardwire handshake, a printer busy signal originating at pin 20, or a modem carrier detect signal originating at pin 8, gets connected to the input busy line over on pin 6.

With the alternate XON/XOFF handshaking, extra characters are inserted into the data stream to stop and start the transmission process.

A handshaking problem usually will not show up immediately. Instead, it is more likely to trash things after a page or so of data has been transmitted.

One way to service many RS-232 problems is to start out at a very low baud rate, preferably at 110 baud. That will separate all of the handshaking problems from any of the more fundamental communications hassles. Servicing can be done with an oscilloscope or a plug-in breakout box.

A good baseline for initial printer work is to separately cross pins 2 and 3 and to tie pins 6, 8, and 20 together.

One RS-232 problem unique to the COM1: port of an IBM clone is that it will expect some auxiliary handshake signals on pins 4 and 5, while most cables and most other communications do not provide those pins at all. One solution is to directly short pins 4 and 5 on the COM1: connector.

Many modern computer circuits use a single +5-volt supply, and do not have the higher positive and negative voltages as needed for RS-232. The simple circuit of Fig. 4 handles that problem. The IC shown internally generates its own ± 10 volts, starting with a single +5-volt supply. The MAX232 IC is a Maxim product.

Memory upgrades

We sure get a lot of questions on this topic. The caller usually has an

older "Flugelhoffer-8" or whatever personal computer and had just noticed that the pinouts on today's jelly bean 256K memory IC are more or less the same as on the 16K dynamic RAM's already installed in his computer.

Couldn't he simply swap out his IC's and dramatically increase the memory he has available on his older machine?

The answer is that, yes, that is usually theoretically possible. But the time, hassle, and involvement needed to pull it off almost always is not worth the effort.

If—and this is a very big if—your computer already has a provision for memory expansion, then the IC's can be added without much hassle. For instance, even on the earliest of 128K *Macintosh* computers, you could piggyback additional memory up to 512K without creating too many new problems.

In general, though, the larger IC's will do you no good whatsoever. It is only when you can simply and positively answer the following questions that a memory upgrade is reasonable:

(1) Where are the extra address lines going to come from?

(2) How is the dynamic refresh and the address-pin multiplexing going to be done for those extra address pins?

(3) How is memory management beyond 64K being handled and by what bank-switching circuitry, activated in which manner?

(4) What modifications will be needed for the firmware monitor and the disk-operating system to recognize the new memory?

(5) How is the existing software going to be modified to access the new memory, particularly if that locked and protected software was sold by a now-bankrupt firm?

Now, those are certainly all solvable problems. But the kicker is that if you are the type of person that can solve them, your time will be so valuable that you'll usually have far better things to be doing.

Perspective transformations

I've been having a lot of fun lately with some new perspective-drawing routines that I recently created. Those let any plain old word processor and a PostScript printer produce absolutely stun-

ning graphic images. Unlike all of the far more expensive routes to perspective drawing, my routines will automatically handle true perspective lettering(!) of any style in any font, along with precise perspective circles and arcs.

Yes, you can now even do an animated flyby, changing both your position and viewpoint with a very few keystrokes. Individual objects can also all be separately rotated inside the total view.

Figure 5 shows you a typical sample. Not too shabby for old AppleWriter on an Apple *Ile* or *Iigs*, eh what? The PostScript data file on that is about the same length as a business memo. You do, of course, need to use a PostScript-speaking printer as an output device.

What I would like to do here is share with you the fundamental perspective transformations. The chances are that you can apply those to any graphics program, even out of BASIC. Only simple high-school math is involved.

The perspective most people use most often is known as two-point perspective, in which all vertical lines stay that way. The simpler one-point perspective that you would get while looking down a long hallway is a special centered case of two-point perspective.

At any rate, Figs. 6 and 7 show you both the transformations needed to convert a three-dimensional object directly into a two-dimensional representation.

Let's assume that you had a giant plane of glass between you and your subject. We'll call that plane of glass our picture plane. We'll start an origin at the center bottom of the picture plane. We'll use *xx* for the back and forth distance with right positive. We will make *yy* the distance into the picture with the farther from you being the more positive. And, we'll use *zz* for up and down with positive being up.

Next, we'll assume that you will be standing pretty far in front of the picture plane. We can call *xo*, *yo*, and *zo* the distance from the plane to your eyeball. In general, for two-point perspective to work, you will want to stand far back, using a rather large *yo*. Otherwise, your perspective illusion will dis-

Free Famous hi-tech catalog



A very special guide to what the exciting world of computer and electronics kit-building can do for you.

The informative Heathkit Catalog shows you more than 450 exciting electronic products that will challenge, instruct, and entertain you. You'll find countless kits that you can build and enjoy, from computers and robots to color tv's and a variety of home products. And each is backed by our years of experience and our promise, "We won't let you fail!"



IBM-PC Compatible Expandable Computers



HERO® 2000 Educational Robot and Courseware

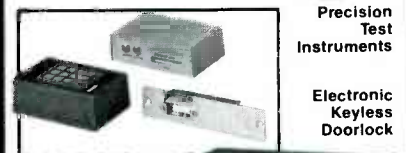

Precision Test Instruments

Electronic Keyless Doorlock



PackKit Multi-Mode TNC



Send NOW for your FREE Heathkit Catalog.

Send to: Heath Company, Dept. 020-662 Benton Harbor, Michigan 49022

Name _____

Address _____

City _____ State _____ Zip _____

A subsidiary of Zenith Electronics Corporation CL-784R3



CIRCLE 86 ON FREE INFORMATION CARD

tort and fail. Many times, you might want your **zo** to match your standard eyeball height, particularly on any of your architectural drawings.

We'll call **X** the back-and-forth distance on both the final paper and your picture plane, and **Y** the up-and-down distance on the paper and the plane. As Figs. 6 and 7 show us, two simple similar triangles are all that is needed to transform your perspective image to the final page.

All that my routines or your new computer's program have to do is solve those similar triangles for each and every endpoint of each and every line to be drawn. While painful for people, that is utterly trivial for a computer.

New tech info

There's a whole pile of new data books this month. On top of the stack are the new *FET Data Book* by Siliconix, a *Programmable Logic Handbook* from Advanced Micro

Devices, a *Xicor Data Book* that includes info on the EEPOT's we looked at a few columns back, and a new *Optical Semiconductor Catalog* from Mitsubishi that's got some interesting solid-state laser stuff in it.

One of my favorite low-cost sources for small mechanical parts in small quantities, for robotics or whatever, are the Small Parts people. Besides all sorts of hard-to-get hardware, they can also custom-cut smaller pieces of metal and plastic for you.

If you need any rubber sheeting or tubing, again at very reasonable prices, investigate Hygenic. That outfit is an especially good source for the low-pressure pneumatic stuff we recently looked at.

Turning to my own products, if you are thinking of starting your own craft or tech venture, be sure to look into my *Incredible Secret Money Machine* book. And, coincidentally, I do seem to have some pre-release disks now available on my new *PostScript Perspective Drawing and Lettering Utilities*, configured for most major personal computers. R-E



Celebrating our 10th Year in U.S.A. . . .

Proven Quality . . .

Factory Direct Prices!

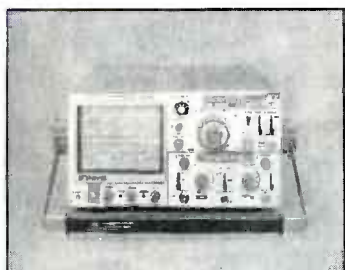

COS 5100: 100 MHz

- 3 Channel, 8 Trace
- P-P level-lock auto-trigger
- Delayed Sweep

Now Only
\$999.00

COS 5042TM, 40 MHz **\$779.00**

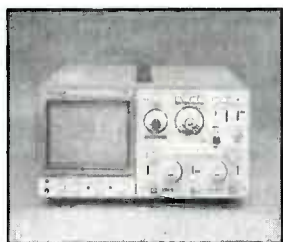

COS 5041TM

- 40 MHz, Delayed Sweep
- 2 Channel
- Ch 1 Signal Output

\$669.00

COS 5021TM

- 20 MHz, Delayed Sweep
- 2 Channel
- Ch 1 Signal Output

\$489.00

255 Frequency Counter:
150 MHz **\$299.00**

FCO1130 Frequency
Counter: 1GHz **\$739.00**

677D Wow and Flutter
Meter **\$949.00**

6701 Wow and Flutter
Meter **\$999.00**

COS 5040TM

- 40 MHz
- 2 Channel
- CH 1 Signal Output

\$639.00

COS 5020TM

- 20 MHz
- 2 Channel
- CH 1 Signal Output

\$449.00

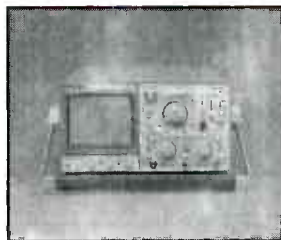

COS 5060TM

- 3 Channel, 8 Trace
- P-P level-lock auto-trigger
- Delayed Sweep

\$889.00

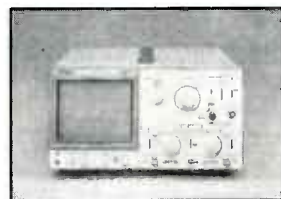

Add \$15 per unit shipping and handling.

(800) 545-8784

(213) 371-4662
Collect CA & AK

Local Service Centers
Nationwide

©Copyright Kikusui International Corp. 1988



Kikusui International Corp.
19601 Mariner Avenue
Torrance, CA 90503

CIRCLE 181 ON FREE INFORMATION CARD

CONVERTERS & CABLE DECODERS

INFORMATION

402-554-0417

Orders & Free Catalog

1-800-624-1150

ALL PRODUCTS GUARANTEED

New Stargate 2000	\$99.00
SB-3/2.....	\$89.00
Tri-Bi Mode.....	\$99.00
Hamlin MLD-1200.....	\$100.00
Oak N-12 W/V.S.....	\$99.00
Panasonic.....	\$99.00
Oak-M-35-B W/V.S.....	\$100.00
Zenith SSAVI.....	\$185.00
Eagle PD-3.....	\$110.00
Scientific Atlanta.....	\$120.00
Pioneer W/ Parental.....	\$105.00
Tocom.....	Call
Oak N-12 W/ Auto.....	\$140.00
Evaluator Tap Detector..	\$495.00
ViewStar Volume+.....	\$129.95
Jerrold Starcom CSV....	\$139.95

M.D. ELECTRONICS
5078 SO. 108th
SUITE 115MD
OMAHA, NE. 68137

CIRCLE 53 ON FREE INFORMATION CARD

DRAWING BOARD

Z80 hardware



ROBERT GROSSBLATT,
CIRCUITS EDITOR

TO PARAPHRASE A CERTAIN WALRUS, the time has come to talk of many practical things. We've spent the last several columns going through the theory, control lines, and timing requirements that have to come into play when you use dynamic RAM with the Z80 microprocessor. By now we have enough facts under our belt to start looking at some hardware.

Since this column hasn't appeared in quite a few months, I better remind you that I'm referring to the May, July, and December 1987 issues. It's good to be back, and I'm looking forward to appearing monthly once again in **Radio-Electronics**.

Reset circuitry

The first part of the circuit we have to deal with is the reset circuitry. Figure 1 shows one way to handle it. The circuit can get a bit complex because there are three circumstances under which we want a reset performed:

- When the circuit is first powered up.
- On demand by an external circuit.
- By pressing a manual reset button.

Each of those has to be handled separately and the last two have to be tied into the Z80 timing.

A negative-going pulse is generated at power up by R5 and C3 and is applied to the Z80's reset input at pin 26 through R6. That clears the Z80's program counter and starts program execution at address 0000H. The other two reset pulses can't be generated as easily since they'll only come into play after

power up when there's a good chance that the contents of memory will have to be preserved.

If a reset is generated during the time that the Z80 is talking to memory, there's no way of being sure that you won't glitch the location being accessed. The way around that is to synchronize the reset pulse with the beginning of the M1 cycle. Fortunately, the Z80 makes that easy since it announces the start of a new machine cycle by bringing the M1 line low. The reset circuitry in Fig. 1 uses the M1 line from the Z80 as a trigger for the half monostable made up of R1, C1, and IC1-a. That results in a 250 nanosecond, positive pulse at pin 8 of IC1-c at the start of each machine cycle. The output of IC1-c won't go low unless a high is presented to pin 9 of IC1-c and that only happens when a negative-go-

ing reset signal shows up at the input of IC1-b.

Both the external and the manual reset signals are debounced by R2 and C2 before they cause the output of IC1-b to go high. As soon as an M1 cycle is started, a reset pulse will be sent to the Z80 through R4. As you can see, since the reset can only take place during an op-code fetch, there's just no way memory contents can be disturbed. Not only that, but we can also be sure that the reset pulse will never be wider than 250 nanoseconds. That is important because the Z80 doesn't execute any instructions during a reset and, since we're using the Z80 to refresh RAM, we can't let it stay idle for longer than 1 millisecond. If Z80 inactivity lasts any longer, the contents of memory will be lost.

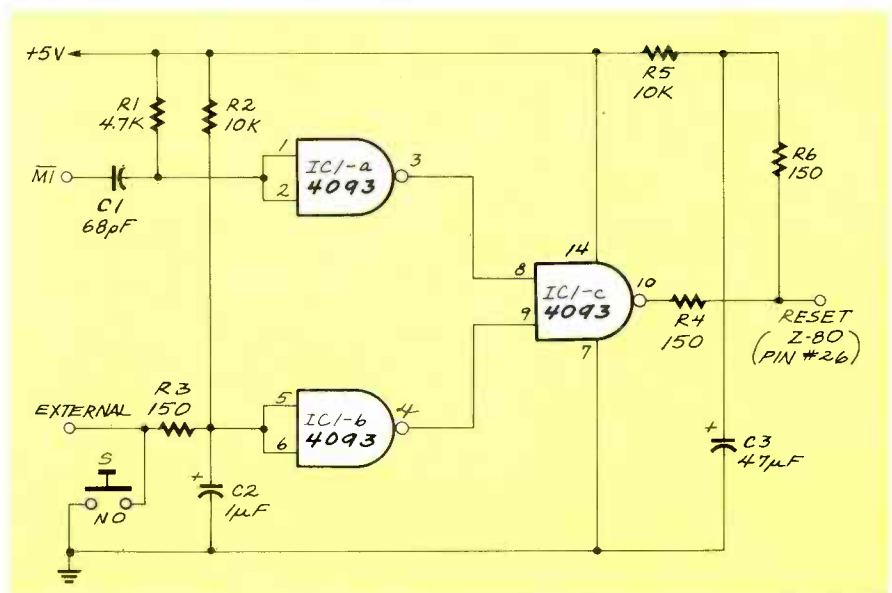

FIG. 1

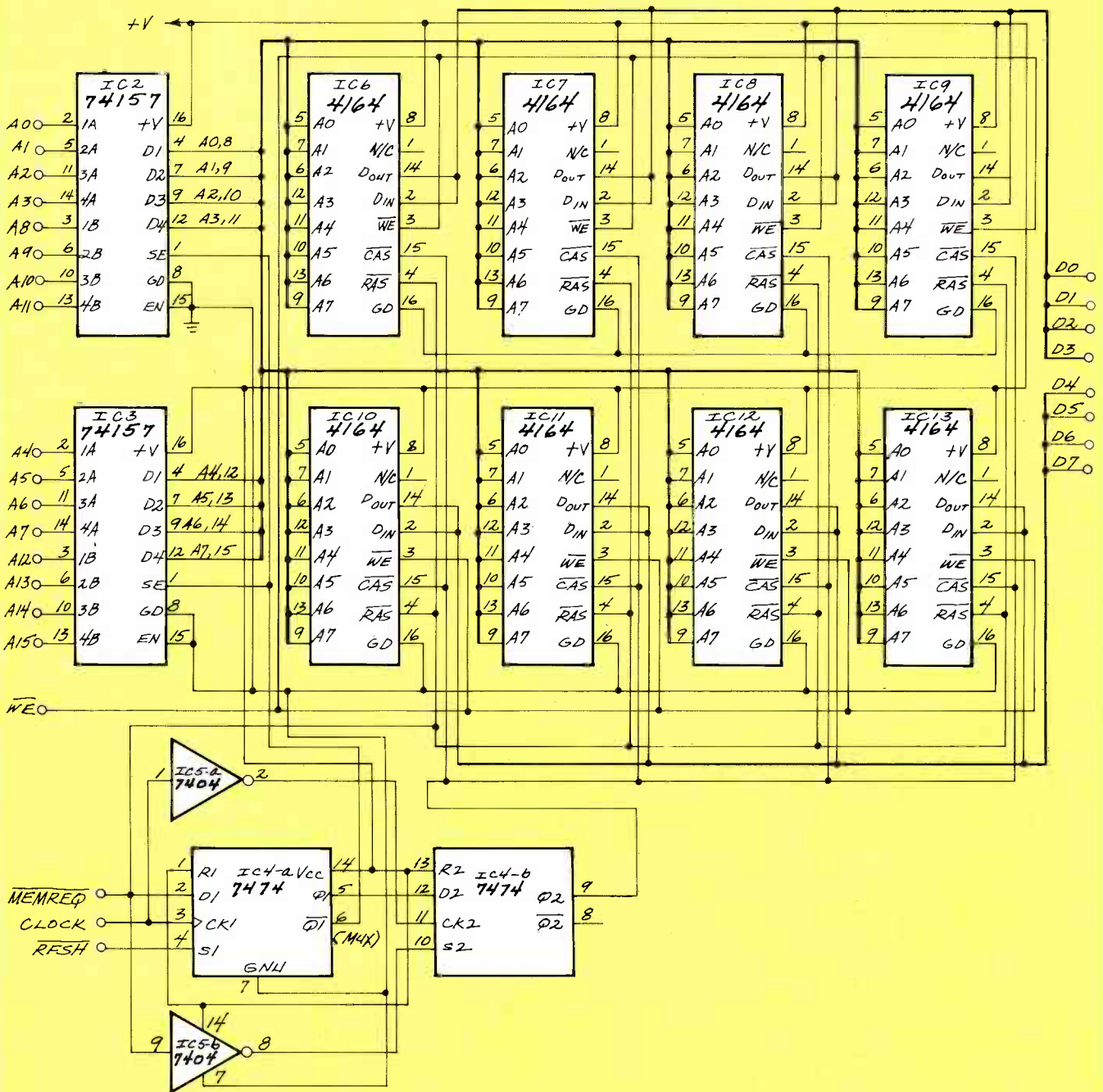

FIG. 2

DRAM refresh

Now that we've taken care of the reset circuitry, let's turn to the really sticky part of dynamic RAM—refresh. You'll recall that DRAM's use a multiplexed address scheme to squeeze 64K (and more) into a 16-pin package. The memory has internal latches to store the row and column addresses that are sequentially presented to the IC's address pins. The DRAM's need a separate ROW ADDRESS STROBE (RAS) and a COLUMN ADDRESS STROBE (CAS) to store both

halves of the full address.

In theory the procedure is simple. You present the row address to the IC and generate the RAS signal, then you present the column address to the same pins and then generate the CAS signal. In practice, however, it takes a bit of work. The address has to be split and control signals have to be generated to clock the address into the DRAM. The schematic in Fig. 2 is one way to solve the problem.

The two 74157 data selectors, IC2 and IC3, are used to split the 16-bit

address into two 8-bit parts. When the SELECT input, pin 1, is low, the A inputs are routed to the output and when pin 1 is high, the B inputs appear at the outputs. As you can see from the drawing, the low-order address bits are connected to the A inputs, the high-order address bits are connected to the B inputs, and the SELECT input, pin 1, which is used to control which half of the address will show up at the outputs, is toggled by the MUX signal, which we have to derive from the standard Z80 control lines.

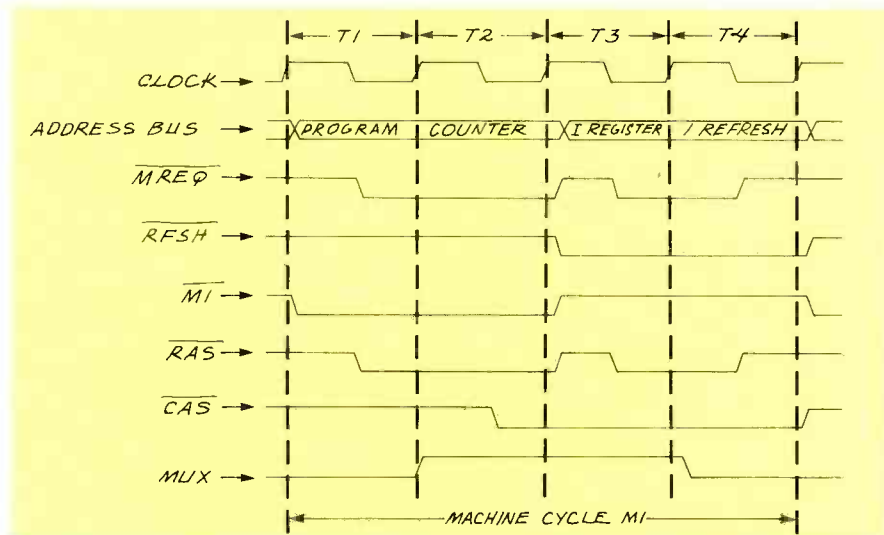

FIG. 3

The three control lines we have to generate are RAS, CAS, and MUX. The two flip-flops, IC4-a and IC4-b, have the job of taking the MEMREQ and RFSH lines from the Z80 and creating the three signals we need to properly talk to the DRAM. There are other ways to deal with the problem, but using clocked logic is an advantage since all the lines can be synchronized with the main system clock.

Since the Z80 begins all memory operations by bringing MEMREQ low, it's possible to make that line identical to RAS. Don't forget that the row addresses are the only ones we need for a refresh and they're also the first ones that have to be presented to the memory during a read or write operation. MEMREQ is high at the beginning of the T1 period. Since that line is also used as the D1 input of IC4-a, the inverted output (the MUX line), is low at the same time. That causes IC2 and IC3 to put the row addresses on their outputs.

The next change takes place on the rising edge of the T2 cycle. MEMREQ and RAS go low (since they're both the same line) and that causes the DRAM's to internally latch the row address. As soon as IC4-a is triggered, it puts a high on the MUX line causing IC2 and IC3 to put the high-order (column) address on their outputs.

The non-inverted output of IC4-a is used as the D2 input of IC4-b and is, consequently, always opposite to the MUX line. Since IC4-b is clocked by an inverted version of the system clock, the CAS line

(the Q2 output) it doesn't get triggered until the falling edge of T2. Notice that the s input is connected to the MEMREQ line by an inverter. That keeps it low whenever MEMREQ is inactive and, as a result, forces the flip-flop to put a high on CAS. IC4-b is only allowed to change state when MEMREQ is active. That means that CAS can only be clocked low when MEMREQ is low.

When the clock gets to the falling edge of the T2 period, it's converted to a rising edge by IC5-a. The low at IC4-a's D1 input is clocked to the Q1 output (the CAS line) and the column addresses are internally latched in the DRAM's.

It's very important to understand what we've discussed thus far before going any further. Study the schematic and the timing diagram shown in Fig. 3, and draw up truth tables if that helps, until you are sure that you see how the various control signals are related. There's just no way you're going to be able to follow the rest of this discussion unless you get all those basic relationships straight in your mind.

Once you've got a handle on what we've done so far, you'll realize that what we've been describing has to do with general memory reads and writes; I haven't said anything whatsoever about refresh. Now that we've gone through basic timing, however, understanding how a refresh cycle is handled is simple.

The Z80's RFSH line is directly connected to the s input of IC4-a

and, if you're familiar with the truth table of the 7475, you know that we don't have to do anything else. Remember that when the Z80 decides it's time to do a refresh operation, the first thing it does is bring RFSH low. That forces IC4-a to immediately put a high on the Q1 output and a low on the Q1 (MUX) output. As with any memory operation, a low on MUX causes the low-order address to be presented to the memory by IC2 and IC3. That happens just after the beginning of the T3 period.

We've already seen that the Z80 uses the T3 and T4 periods of the M1 cycle to internally decode the op code it fetched during the first two T periods. Immediately after the falling edge of the T3 period, the Z80 activates MEMREQ by dropping it low. Since MEMREQ and RAS are the same line, a read is done on the memory row being addressed and, as we've already discussed, that causes a refresh on that entire row.

So what have we designed so far? After all this work, there's still more to do. We need some way to handle the data bus, some I/O to get access to the system, a system clock, and a basic BIOS that will do three jobs: It has to manage the I/O, manage the memory, and, in case we've forgotten, keep the Z80 busy since, if it's idle for more than 1 millisecond, the data in memory will disappear.

And after all we've been through, it would be disappointing (to say the least) to have our data fade away.

Next time

I'm sorry I haven't been able to announce the winners in the DTMF contest, but as you've seen, there just wasn't enough room. I'll try to do it next time since I think we'll be able to finish up the design of this circuit then.

We've covered an awful lot of territory in this installment and I've stuffed loads of circuit stuff into your brain. Take the time to go over this circuit and get its operation clear in your mind since the next installment will be just as heavy and there is no way you'll understand one word of it without having this month's material straight in your mind. **R-E**

AUDIO UPDATE

Getting the noise out of FM



LARRY KLEIN
AUDIO EDITOR

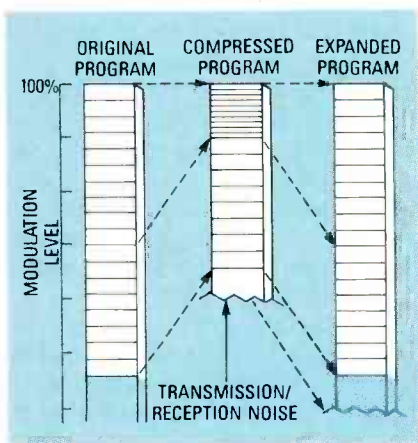

FIG. 1

THE YEAR 1958 SAW TWO SEMI-RELATED hi-fi events of note: The U.S. FM broadcast industry finally began to show a profit, and the conflict among the various proposed stereo-disc technologies was resolved in favor of the 45°/45° groove-modulation system that is still in use today. But the new stereo discs could not be broadcast in stereo for the simple reason that FM was still being broadcast in mono.

The path to stereo FM was road-blocked mostly by those broadcasters who had a substantial investment in—or income from—broadcasting background music to supermarkets and offices using an SCA subchannel of their regular FM broadcasts. It seems that all the proposed FM-stereo systems would either usurp the SCA frequencies or—horror of horrors—render them audible to anyone with a FM-stereo multiplex tuner. After much back-and-forth byplay, threats of lawsuits, and so forth, in April 1961 the FCC finally decided in favor of the GE/Zenith system,

one that had been largely ignored as a serious contender by the hi-fi magazines. It shortly became the world-wide FM-stereo broadcast standard.

It didn't take long, however, for most listeners to become aware that even with the best available stereo tuners, they heard much more background hiss in stereo than in mono. The solution recommended by the experts was to install an outdoor antenna—in fact, it was gospel during the sixties that an outdoor antenna was essential equipment for reasonably quiet FM-stereo reception.

What was the problem? Simply this: A stereo signal is effectively 23 dB weaker than a mono signal. The problem arises in the technique used to encode the stereo information in the FM broadcast.

While still in audio form, the original separate left (L) and right (R) channels are mixed and manipulated to provide an L plus R “sum” signal and an L minus R “difference” signal. The L + R is broadcast as the main signal and provides a fully compatible program on mono radios. However, the L – R component—which is also transmitted as part of the composite FM signal—is carried on an AM (not FM) 38-kHz suppressed subcarrier.

When recovered by the tuner's multiplex decoder, the L – R signal suffers substantial S/N degradation compared with the L + R component. When a tuner's matrixing circuits recombine the relatively clean L + R signal with the noisy L – R signal, the result is separate, but noisy, L and R signals. Of

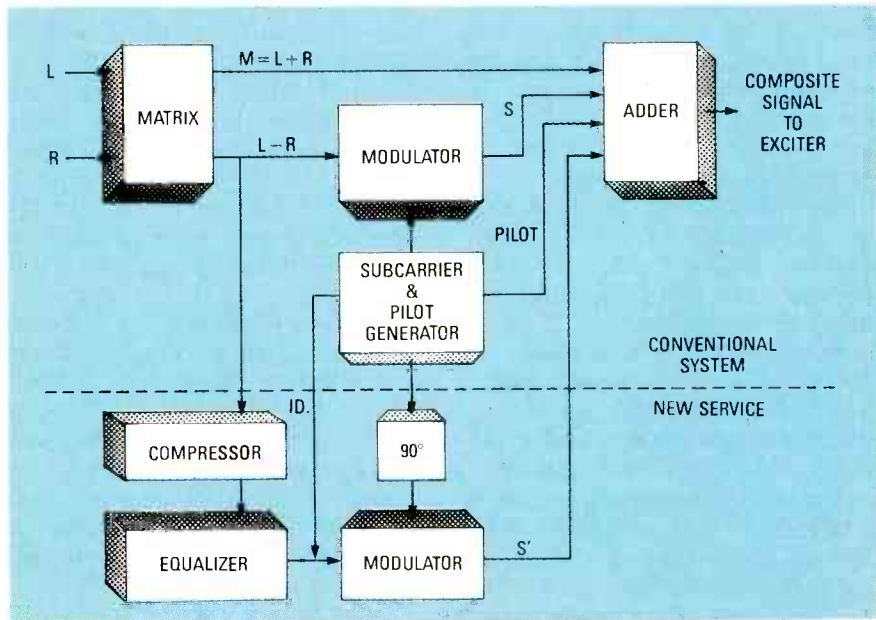

FIG. 2

course, when the tuner is receiving an adequately strong signal and its sensitivity is high enough, the noise may be low enough to be inaudible.

Attacking the noise problem

Since the noise problem originates in the L-R signal, obviously that's the place to apply a cure. Early in 1986, the CBS Technology Center, which has long been involved in professional broadcasting instrumentation, announced the development of the FMX broadcast system, a new approach to stereo transmission. FMX addresses the problem of the noisy L-R signal by encoding it with a compression/expansion (compansion) noise-reduction process (shown in Fig. 1) not unlike dbx or Dolby.

In their original technical data sheet on the system, CBS showed a map indicating that the noise-free (i.e., 60 dB S/N) reception area for an FMX-encoded signal was close to that of a mono signal—which also meant four times that of a conventional stereo signal. For

DOES YOUR DIGITAL CAPACITANCE METER DO THIS?

FULL 4 DIGIT 0.5 INCH LCD DISPLAY COMPLETELY AUTORANGING WITH 10 RANGE MANUAL CAPABILITY

AND THIS
RANGE OF 0.0 pF to 1 FARAD (999.9 mF)
0.5% BASIC ACCURACY UP TO 100 uF

AND THIS
READS DIELECTRIC ABSORPTION

AND THIS
EXTENDED PSEUDO 5 DIGIT
RESOLUTION ON SOME RANGES ONLY

AND THIS
ABILITY TO ZERO LARGE CAPACITANCE
VALUES UP TO 99.99 uF

AND THIS
CALCULATES TRUE CAPACITANCE
IF CAPACITOR IS LEAKY

AND THIS
DIOLE CLAMP AND FUSED
PROTECTED INPUT.
DISCHARGE RESISTOR IN OFF
POSITION AT TERMINAL INPUTS.
POWERED BY 9V BATTERY

**ONE YEAR PARTS &
LABOUR WARRANTY**

FOR ONLY THIS

\$169.95

MODEL
MC300 Approx. Size
7" x 4" x 1 1/2"
DAETRON
a division of Bergeron Technologies Inc.
935 THE QUEENSWAY, BOX 641
TORONTO, ONTARIO M8Z 5Y9
CANADA (416)676-1600



AND THIS
IDENTIFIES TRANSISTORS (NPN, PNP)
AND THEIR LEADS (E, B, C, ETC.)

AND THIS
TESTS ZENER DIODES AND RECTIFIERS
UP TO 20V ZENER WITH AC ADAPTOR,
ZENER VOLTAGE WITH 9V BATTERY
DEPENDS ON ITS CONDITION

AND THIS
AUTOMATICALLY CALCULATES LENGTHS
OF CABLES IN FEET, METRES, MILES,
KILOMETRES (THEORETICAL RANGE
OF 9,999 MILES)

AND THIS
ABILITY TO SORT CAPACITORS IN
MANY DIFFERENT MODES

AND THIS
ABILITY TO READ LEAKY CAPACITANCE
(INSULATION RESISTANCE OR CURRENT)

AND THIS
CALCULATES TIME CONSTANTS WITH
USER DEFINED RESISTANCE VALUES

AND THIS
HOLD FUNCTION FREEZES DISPLAY

SHIPPING INSTRUCTIONS:

All units shipped out F.O.B. Buffalo NY via United Parcel Service (except Hawaii & Alaska) unless otherwise indicated (in which case shipments will be F.O.B. Canada)

PLEASE SEND ME		U.S. FUNDS
(QUANTITY) MC300(S) (r)	\$169.95	\$ _____
CARRYING CASE	\$ 16.95	\$ _____
AC ADAPTOR	\$ 9.95	\$ _____
SHIPPING AND HANDLING (r) \$5.00 PER INSTRUMENT		\$ _____
<input type="checkbox"/> CHECK <input type="checkbox"/> MONEY ORDER		\$ _____
<input type="checkbox"/> VISA <input type="checkbox"/> MASTERCARD	TOTAL	\$ _____
<input type="checkbox"/> CARD NO		
EXPIRY DATE	SIGNATURE	
NAME	TELEPHONE	
ADDRESS		
CITY	STATE	ZIP CODE

DEALER ENQUIRIES INVITED

CIRCLE 191 ON FREE INFORMATION CARD

GUARANTEED PERFORMANCE!!

METERS
FLUKE

- 73 3 1/2" digit, DMM **\$67**
- 75 3 1/2" digit, DMM 99
- 77 3 1/2" digit, DMM 119
- 8060A 4 1/2" digit-true RMA 323
- 8062A 4 1/2" digit-true RMA 260
- 37 Bench/portable DMM 217
- 8010A Bench/portable true RMS 255
- 8012A Bench/portable true RMS 318
- 8050A Bench/portable true RMS 349

- BECKMAN**
Beckman Industrial
- DM15B 3 1/2" digit, 26 ranges, beeper **\$51.98**
 - DM25L 3 1/2" digit, 29 ranges, logic probe, cap measure 94.50
 - DM850 4 1/2" digit, frequency counter, data hold 207.83
 - Tech300 Diode Test 113.00
 - Tech330 True RMS, Diode Test 206.00
 - DM73 Probe-Auto-ranging, beeper, data hold 55.00
 - CC6 Clamp-on meters (measure up to 600 amps) 68.18

SCOPES
HITACHI Hitachi
3 Years Manufacturers Warranty parts & labor

- Special**
- V-212 20 MHz dual trace scope **\$365**
 - V-222 20 MHz dual trace scope 550
 - V-423 40 MHz dual trace, delayed sweep scope 795
 - V-660 60 MHz dual trace scope 999
 - V-665 60 MHz dual trace/cursor readout scope 1245
 - V-1060 100 MHz dual trace scope 1294
 - V-1065 100 MHz cursor readout scope 1544
 - V-6020 20 MHz digital storage scope 1745

- Beckman**
- 9020 20 MHz dual trace scope, component tester, delay sweep 468
 - 2120 20 MHz dual trace scope 385

- IWATSU**
- DS-6411 40 MHz digital storage scope 223.78
 - DS-6612 60 MHz digital storage scope **\$147**
 - SS-5706 30 MHz 3 channel scope 220
 - SS-5705 40 MHz 3 channel scope 205

POWER SUPPLIES
Viz

- WP-702A Dual 0-20VDC (r) 0-200MA, dual meter **\$190**
- WP-703A Single 0-20VDC (r) 0-500MA, single meter 146
- WP-704A Single 0-40VDC (r) 0-250MA, single meter 146
- WP-705A Single 0-50VDC (r) 0-2A, digital meter 349
- WP-706A Single 0-25VDC (r) 0-4A, digital meter 370
- WP-707A Dual 0-25VDC (r) 0-2A, digital meter 465
- WP-31A Isolation transformer 1.5KVVA, 3 fixed 350VA outputs 223.78

IC TESTER
B&K

- 560 Programmable IC tester **\$297.00**
- 541 Component tester 364
- 550 T.T.L. IC comparator 364
- 552 CMOS i.C. comparator 364

SOLDERING SUPPLIES
Ungar

- UTC 100 Temperature controlled soldering system **\$67**
- 4024 De-soldering service station 414
- 9000 Temperature controlled soldering station 208
- 6970 HD Heat gun (gives 1000 watts) 72
- 1095 Heat gun (gives 1000 watts) 35
- 1100 Soldering gun 100/140 watts 20

WELLER

- WTCPR Control output soldering station **\$119**
- 8200 All purpose soldering gun 21
- D550 28.58

Kester solder and multicore solder available CALL!



"I GUARANTEE YOUR SATISFACTION!"

For 43 years professionals have counted on KELVIN, for the lowest prices and immediate delivery, from our huge inventory. Count on KELVIN!
Lisa S. Hadar
Executive V.P., C.P.A.

WE CARRY
Panavise, Xcelite Tools, Vaco Tools, X-Acto, Kester Solder, Sellastron Safety Equipment

- Electronic Parts
 - Electrical Parts
 - Large Selection of State of the Art Educational Kits.
- Not Responsible For Typographical Errors.

KELVIN **FREE CATALOG** **1-800-645-9212**

ELECTRONICS 7 FAIRCHILD AVE., PLAINVIEW, N.Y. 11803 (516)349-7620 FAX: 516-349-7830

CIRCLE 195 ON FREE INFORMATION CARD

www.americanradiohistory.com

Nine Test Probes with only one difference between them and your scope's original equipment

Manufacturers Scope	Original Probe	Price	Coline/TPI Equivalent	
TEKTRONIX				
2300 Series	P6101A	\$53	M12X1	\$38
	P6108A	\$75	M12X10	\$62
2200 Series	P6121	\$100	M12X10AP	\$68
	P6122	\$58	P100	\$38
2400 Series	P6131	\$140	M15X10HFAP	\$87
	P6133	\$115	M12X10AP	\$68
400 Series	P6105A	\$93	M12X10AP	\$68
	P6106A	\$140	M15X10HFAP	\$87
	P6130	\$130	M12X10AP	\$68

IWATSU				
SS-5321	SS-0014	\$92	M12X10	\$62
SS-5711	SS-0012	\$77	M12X10	\$68

LEADER				
LBO-315	LP-060X	\$60	SP100	\$68
LBO-518	LP-100X	\$76	SP100	\$68

PHILIPS				
PM3267	PM8924	\$60	M12X1	\$68
& PM3256	PM8926	\$70	P100	\$38
PM3264	PM8928	\$95	M12X10	\$62

HITACHI				
V-1100A	AT-10AL1.5	\$64	SP100	\$68
V-670				
V-509				

HEWLETT PACKARD				
1715A	10018A	\$135	M20X10	\$68
1722B	10017A	\$130	M15X10HF	\$79
1725A	10017A	\$130	M15X10HF	\$79
1740 Series	10041A	\$135	P100	\$38
	10021A	\$85	IP20	\$29

Take up the TPI challenge and compare our prices with the probes you currently use. In many cases you can replace both probes on your dual trace scope at the cost of one probe from the scope manufacturer. Plus, bandwidth and overall performance of the TPI probe typically exceed that of the original equipment. Satisfaction is guaranteed with a ten day return privilege. TPI Specialists in probes for over 15 years.

Available from your local distributor.

TOLL FREE INFORMATION LINE
1-800-368-5719,
1-800-643-8382 in California

TEST PROBES, INC. TPI

9178 Brown Deer Road, San Diego CA, 92121. Phone: (619) 535-9292.

SEND NOW FOR YOUR **FREE CATALOGUE**

Name _____
 Address _____
 City _____
 State _____ Zip Code _____

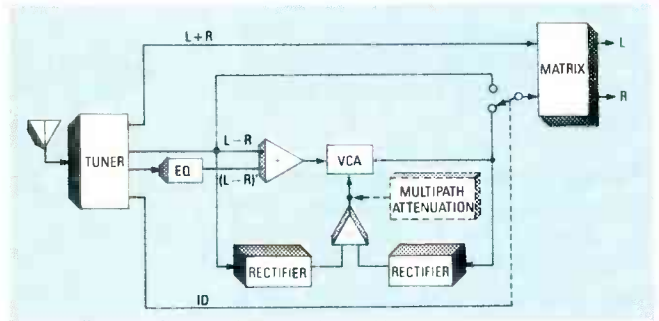

FIG. 3

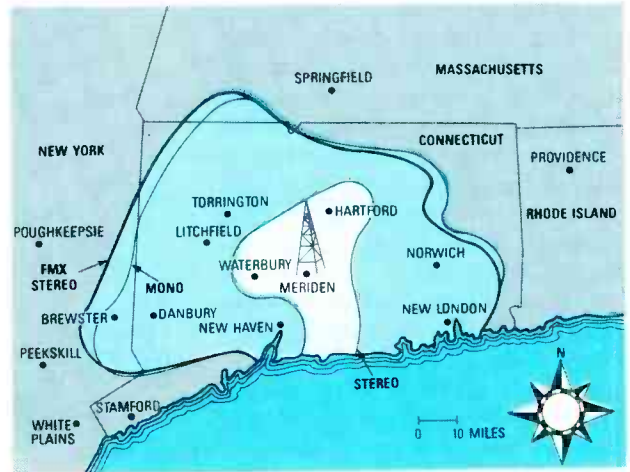

FIG. 4

broadcasters, that translates into an immediate expansion of their stereo-program coverage area. And since a wider audience usually means enhanced revenues, one might have predicted rapid adoption of FMX by the broadcast industry, particularly since their trade organization, the National Association of Broadcasters (NAB) is given joint credit along with CBS for having developed FMX.

The broadcast and reception of the companded L-R signal requires modifications of both transmitters and home receivers. At the broadcast end, the problem is how to incorporate the compressed L-R signal in the transmitted composite FM signal without using additional bandwidth, or invoking other FCC concerns. The compressed L-R signal can't simply be substituted for the normal L-R signal because it's not usable by receivers that aren't equipped with expansion decoders. The FMX solution was to separately modulate the compressed L-R in quadrature (out of phase) with the normal L-R signal. The normal L-R signal then provides normal stereo with non-FMX receivers; in FMX equipment it serves only as a reference signal to ensure the accurate decoding (expansion) of the compressed L-R signal. Figures 2 and 3 show the block diagrams of an FMX-equipped transmitter and receiver respectively. The noise reduction achieved by FMX was originally claimed to be better than 20 dB. Incidentally, the FMX transmission also includes a 10-Hz pilot signal that serves to automatically switch equipped receivers to the FMX mode—and to turn on an FMX-signal light.

As an extra bonus, FMX was also claimed to reduce car-stereo picket-fencing effects. Picket fencing re-

sults from rapid fluctuations of signal strength above and below the noise level; FMX's ability to maintain an effectively high signal level helps keep the signal above the noise.

Start-up difficulties

When FMX was first announced, many audio companies expressed interest. Here was an opportunity to significantly enhance FM reception in the home. The technology was relatively inexpensive and would increase the effective sensitivity of existing tuner designs beyond previous theoretical limits. One company, NAD, committed themselves solidly to FMX by including FMX circuits in a production run of their excellent 4300 monitor series tuner.

There appears to be some controversy as to exactly how things went wrong at that point. Broadcast field tests of the FMX system by station WPKT in Meridan, Connecticut, had been completed—and deemed successful. Figure 4 shows how the coverage area for FMX stereo reception is as large as the coverage area for mono. But subsequent tests by WFMT in Chicago during the Summer 1986 Consumer Electronics Show were judged disappointing at best. It seems that FMX-encoded transmissions somehow worsened multipath effects in *conventional* receivers. And then, for reasons having to do with company restructuring rather than technology, in September 1986 CBS closed down the technology center that developed FMX.

The designers and other parties that were involved in FMX formed Broadcast Technology Partners with the intention of proceeding with the development of FMX. Given its technical problems, did FMX go back to the drawing board in late 1986? No, because it had never really left it, according to Emil Torick, one of the inventors. Others, including the press (and apparently at least one manufacturer) had the impression that what we were shown was a finalized system.

In any case, work on debugging and enhancing the system continued, and the final version was on demonstration throughout the

recent Winter 1988 Consumer Electronics Show. Three local Las Vegas stations transmitted FMX encoded material, and Denon, Fisher, Luxman, Sansui, and others showed and played FMX home-component prototypes. Among the car-stereo manufacturers, there were prototypes from Alpine, Clarion, Concord, Kenwood, Sanyo, Fujitsu, and others. Perhaps more important to the future of FMX, some of the units operated with early samples of FMX

decoder IC's produced by Sanyo. Sprague is also said to be working on an IC. The manufacturer's cost to include FMX circuitry in a receiver is said to be under \$5.

The final version

Referring back to the original technical description of FMX, there are several changes in the way the new circuit handles the compressed L-R signal. First of all, compression has been re-

continued on page 83



CABLE TV SPECIALS CONVERTERS



	JRX-3 DIC—36 Channel Corded Remote	\$129.95
	RCA 58-3 58 channel set top with Jerrold Decode	\$119.95
	SB-3 — 'The Real Thing'	\$109.95
	SB-M-Refurbished	\$89.95
	DRZ-3D1C—68 Channel Wireless with Decoder	\$199.95
ZENITH:	Z-TAC Cable Add-On	\$189.95
VIEW STAR:	MXC 2001—60 Channel Wireless— with Parental Lockout	\$99.95
	MXC 2001 A-B—Same as above with A-B Switch	\$109.95
	MXC 2501—60 Channel Wireless with Volume	\$119.95
	Universal V7472—72 Channel Wireless Remote MTS Stereo Converter-Full Feature Decoder Compatible	\$139.95

MISCELLANEOUS

OAK:	N-12 Mini-Code	\$89.95
	N-12 Mini-Code Vari-Sync	\$99.95
	N-12 Mini-Code Vari-Sync Plus Auto On-Off	\$139.95
OAK:	Sine-wave Anti-Jammer Kit	\$39.95
JERROLD:	400 & 450 Handheld Transmitters	\$29.95
HAMLIN:	MLD-1200 Channels 2 or 3	\$99.95
NEW ITEMS:	Ripco Tape Copy Stabilizer	\$109.95
	Scientific Atlanta SA-3	\$129.95

GENERAL

INSTRUMENTS:	VCU Amplified Video Switch Signal Amplifier	\$59.95
--------------	--	---------

ALL UNITS GUARANTEED. QUANTITY PRICES AVAILABLE.

UNITED ELECTRONIC SUPPLY

P.O. BOX 1206 • ELGIN, ILLINOIS 60121 • 312-697-0600

SHORTWAVE RADIO



STANLEY LEINWOLL,
CONTRIBUTING EDITOR

What makes shortwave possible

AS DAYS CONTINUE TO LENGTHEN IN the northern hemisphere, the ionosphere warms and expands, and the manner in which shortwave radio signals propagate changes dramatically. The longer days mean that the 15-, 17-, and 21-MHz bands will be open for extended periods, with 15 MHz open virtually around-the-clock.

During the nighttime hours, when both the transmitter and the receiving locations are in darkness, 6-, 7-, 9-, and 11-MHz bands will be open for DX, in addition to the 15-MHz openings, which will be most common from Latin America, Africa, the Middle East, and Australasia. As far as your best DX bets are concerned, for daytime try 17 MHz, and for nighttime, use 9 and 11 MHz.

On May 1, many broadcasters will make major frequency changes with the inauguration of their summer schedules. Those schedules will reflect not only increased use of the higher frequencies, but will also be characterized by fewer frequency changes during the broadcast day.

In May and June, noise levels increase because of increased thunderstorm activity. The noise produced by lightning affects primarily the lower frequencies, and proper reception in the 3- and 4-MHz tropical bands will be more difficult.

Shortwave fundamentals

As mentioned in our last column, the ionosphere actually consists of several distinct regions, generally referred to as "layers". Although the height of those

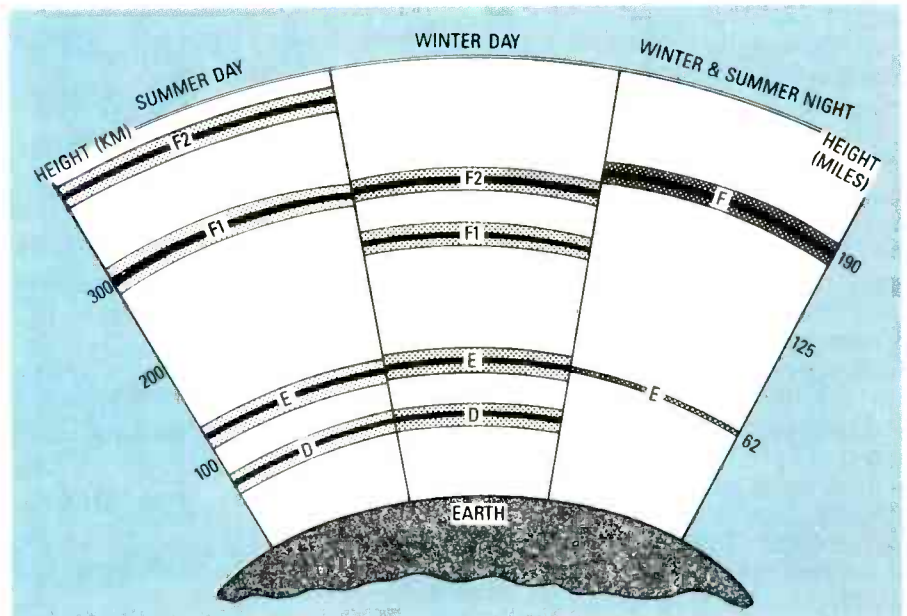

FIG. 1

layers overlap to some extent, they actually are distinct, having different levels of maximum intensity. The layers have been designated as D, E, F1, and F2. The letters were assigned by Sir Edward Appleton, when he discovered the ionosphere (first called the Kennelly-Heaviside layer, after two early researchers). Appleton allocated the letter E to the first layer he discovered because E is the symbol of an electric vector. In 1925 Appleton assigned the letter F to the next layer he discovered, and shortly thereafter the letter D was given to a layer Appleton found below the E layer. That, he said, would give future researchers additional letters to assign as new discoveries were made. The different layers can be seen in Fig. 1.

The D layer

The D layer is the lowest layer of the ionosphere. It extends from about 30 to 55 miles (50 to 90 kilometers) above the surface of Earth. It exists only during the daylight hours, peaking around noon, and then disappearing soon after sunset.

Because of the relatively low levels of ionization in the D layer, it has very little influence on the propagation of shortwave signals. That holds true except during ionospheric storms, when absorption in that region prevents shortwave signals from reaching the higher layers of the ionosphere.

The E layer

The upper boundary of the D layer blends into another region called the E layer. That layer is pres-

ent mainly during the daylight hours at heights between 50 and 75 miles (90 to 120 kilometers). While the height of the E layer may vary somewhat from season to season, it remains relatively constant throughout the day.

The intensity of ionization in the E region is considerably greater than in the D layer, and follows closely the sun's position in the sky. Maximum ionization occurs near noon when the sun is almost directly overhead. As soon as the sun sets, recombination takes place, and the E layer weakens considerably.

The F layers

The F layers are the most important regions of the ionosphere where long-distance shortwave-radio communication is concerned. During the daylight hours, there are two well-defined regions; the F1 layer, at an altitude of 90 to 150 miles (150 to 250 kilometers), and the F2 layer, whose height varies from season to season. In winter, F2's maximum height is about 200 miles; in the summer it is about 300 miles.

The F1 layer behaves much the same way the E layer, with maximum ionization occurring around midday; the layer weakens significantly after sunset. However, unlike the other layers of the ionosphere, the F2 layer exists to a significant extent both day and night. It is the most highly ionized of the layers, and the most important to long-distance shortwave communication. During the nighttime hours, the F2 layer (generally referred to as the F layer because it exists by itself) varies in height from approximately 150 to 250 miles (240 to 400 kilometers). The F layer exists at night because the recombination rate in that region is relatively slow. The intensity of ionization in the F region is in an almost continuous state of flux, with hourly, seasonal, geographical, and cyclical changes taking place.

The sporadic-E (E_s) layer

In addition to the D, E, and F layers, there is another ionized region which is especially interesting. It does not occur with any degree of predictability, and is

therefore referred to as "sporadic". It occurs in the E region of the ionosphere, but is distinct from that region because it isn't primarily dependent upon solar radiation.

Sporadic-E occurs in patches that are highly ionized at an altitude of about 60 miles (100 kilometers). Quite often, those patches are not greater than 50 to 100 miles in diameter. E_s patches are frequently so densely ionized that shortwave signals don't penetrate them. As a result, shortwave signals intended for distant targets are cut off and returned to Earth far short of their target area. (The phenomenon is known as *short skip*). Sometimes, ionization is so intense that it reflects frequencies in the TV portion of the spectrum (mainly channels 2 to 4), as well as the amateur 6-meter band. Very intense E_s sometimes extends to the FM bands and the higher TV channels, as well as the amateur 2-meter band.

Sporadic-E is seasonal in nature. It peaks in the summer months, during the late afternoon. There is a secondary peak in the winter time, often in the late afternoon and at night. In rural and suburban areas E_s can result in serious TV interference on the lower channels, when an E_s propagated signal infringes upon a local signal on the same channel.

Sporadic-E is caused by shearing forces brought on by winds in the lower ionosphere having velocities of the order of several hundred miles per hour. Those winds, which travel in opposite directions, force electrons into a very thin region—sometimes only a few miles thick.

Chit-chat

The number of privately owned U.S. shortwave broadcasting stations continues to grow. At last count there were fifteen stations licensed by the FCC, with six more granted construction permits.

The largest of the privately owned U.S. stations is WYFR, which is scheduled to bring into service its thirteenth and fourteenth transmitters this summer. WYFR, which is a Christian broadcaster, operates transmitters lo-

continued on page 83

Put Professional Knowledge and a COLLEGE DEGREE in your Technical Career through HOME STUDY

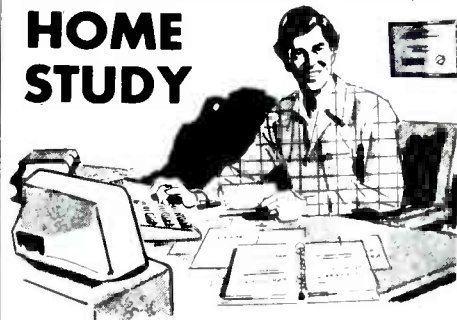

Add prestige and earning power to your technical career by earning your Associate or Bachelor degree through directed home study.

An important part of being prepared to *move up* is holding the right college degree, but the absolutely necessary part is *knowing your field*. Grantham can help you accomplish both objectives—to learn more *and* earn your degree, both of which together will prepare you for promotion in your present employment or for new better employment. Learn much more about

ELECTRONICS and COMPUTERS,

as Grantham helps you *understand* your subjects and become a highly qualified expert, as you move thru the home study program and earn your accredited college degree.

No commuting to class. Study at your own pace, while continuing on your present job. Learn from easy-to-understand lessons, with help from your Grantham instructors when you need it.

Write for our free catalog (see address below) or telephone us at (213) 493-4421 (no collect calls) and ask for our "degree catalog."

Accredited by
the Accrediting Commission of the
National Home Study Council

GRANTHAM
College of Engineering
10570 Humbolt Street
Los Alamitos, CA 90720

JUNE 1988

ANTIQUE RADIOS

Drawing radio schematics



RICHARD D. FITCH,
CONTRIBUTING EDITOR

BACK IN THE 1920'S THERE WAS HARDLY a man on the street who couldn't read a schematic. That was the era of home-built radios. The schematics and parts were available through the radio magazines of that era.

As antique-radio restorers, we need the schematic of an old radio even more than the radioman of that era. At the time, they were working on current models and were more likely to be able to identify faulty components that they would often come across. Unfortunately, even with a schematic we can't always identify some of those old parts.

That's because over the years, there have been many changes in the appearance of certain electronics symbols. Looking at the late 1920's triode in Fig. 1-a, for instance, it appears somewhat different than the way a modern triode is shown in Fig. 1-b. Studying the early diagram (Fig. 1-a), the plate is on one side of the filament, and the grid is on the other. If we didn't know better, we'd think the grid was just a resistor.

Further, many early schematics were not too generous with component values, and voltages were usually non-existent. The power supply was not part of an early schematic diagram at all. To add to the problem, there was the lack of standards in color coding for resistors as well as the wiring in circuits, transformers, and speakers.

But an old-fashioned schematic is better than none at all. Working under the chassis of an early set, many a hobbyist has tried to trace wires with their fingertips, only to

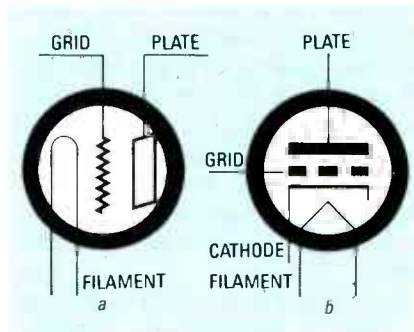

FIG. 1

have to start over again when the wire gets lost under a component or in a maze of other wires. Sometimes we try to draw the circuit on a piece of paper while tracing it, but that's hard to do and there is a better way.

Draw your own

If you have an old set, but don't have a schematic, it's really not too hard to draw your own. You can draw separate sections, or preferably the entire schematic. And you'll find that a hand-drawn schematic is much easier to read than a confusing mess of wires on a piece of paper.

To draw my own schematic I usually start with the tubes. Starting at the left side of a sheet of paper, I draw a circle for each tube and one in the center for the rectifier. I space them across the page leaving a good margin on both sides. Of course, on a superheterodyne receiver, you must leave space between the tubes for the IF transformers. For a complete schematic, make the circles large enough to fit the proper symbols for each type of tube.

Next I get out my tube-base diagrams (all antique-radio hobbyists should have those) and complete the connections for the tubes. On the left margin draw the schematic symbol for an aerial, and on the right margin draw the schematic for the reproducer (the speaker or earphones).

We now have the basic schematic. The input is on the left side and the output is on the right—the usual arrangement. The power supply, while sometimes omitted on early schematics, is usually drawn under the signal circuits. The power supply, including the power transformer, filter condensers, line cord, and the on/off switch are all drawn in that lower section. I finish the power supply by drawing the power transformer. I start with a smaller primary winding on the left, about six vertical lines for the iron core, and the top winding for the rectifier filament, which is not part of the tube filament string.

While the schematic diagram isn't intended to show physical location, you will notice that the component layout on the chassis often somewhat agrees with the component layout on the schematic that you've drawn. The main contradiction to the order is the field coil. If used, the field coil is usually schematically located near the power-supply section. Physically, the field coil is, of course, on the speaker array.

On some large receivers, it would be unwieldy to draw all the tubes on the top line. On those sets, the output section is dropped down to the right side of

R-E Engineering Admart

Rates: Ads are 2 1/4" x 2 7/8". One insertion \$825. Six insertions \$800 each. Twelve insertions \$775 each. Closing date same as regular rate card. Send order with remittance to **Engineering Admart**, Radio Electronics Magazine, 500-B Bi-County Blvd., Farmingdale, NY 11735. Direct telephone inquiries to Arline Fishman, area code-516-293-3000. **Only 100% Engineering ads are accepted for this Admart.**

MIDI PROJECTS

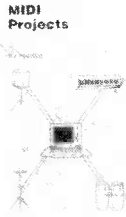

BP182—MIDI interfacing enables any so equipped instruments, regardless of the manufacturer, to be easily connected together and used as a system with easy computer control of these music systems. Combine a computer and some MIDI instruments and you can have what is virtually a programmable orchestra. To get your copy send **\$6.95 plus \$1.00 for shipping** in the U.S. to **Electronic Technology Today Inc.**, P.O. Box 240, Massapequa Park, NY 11762-0240.

FCC LICENSE PREPARATION

The FCC has revised and updated the commercial license exam. The **NEW EXAM** covers updated marine and aviation rules and regulations, transistor and digital circuitry. **THE GENERAL RADIOTELEPHONE OPERATOR LICENSE - STUDY GUIDE** contains the necessary preparation for **ONLY \$25.00.**

WPT PUBLICATIONS
979 Young Street, Suite A
Woodburn, Oregon 97071
Phone (503) 981-6122

CIRCLE 182 ON FREE INFORMATION CARD

117 PRACTICAL IC PROJECTS BUILD YOU CAN

2645T—117 PRACTICAL IC PROJECTS YOU CAN BUILD..... \$10.95. Dozens of fully-tested, ready-to-build circuits you can put together from readily-available, low cost IC's! There are a total of 117 IC circuits ranging from an audio mixer and a signal splitter to a tape-deck amplifier and a top-octave generator organ! From TAB Books. To order your copy send **\$10.95 plus \$2.75 shipping** to **Electronic Technology Today Inc.**, P.O. Box 240, Massapequa Park, NY 11762-0240



117 PRACTICAL IC PROJECTS YOU CAN BUILD..... \$10.95. Dozens of fully-tested, ready-to-build circuits you can put together from readily-available, low cost IC's! There are a total of 117 IC circuits ranging from an audio mixer and a signal splitter to a tape-deck amplifier and a top-octave generator organ! From TAB Books. To order your copy send **\$10.95 plus \$2.75 shipping** to **Electronic Technology Today Inc.**, P.O. Box 240, Massapequa Park, NY 11762-0240

the second row. That section of the receiver includes the output tubes, output transformer, and the speaker.

Filament string

There are probably more ways to depict the filament connections for the tubes than any other kind of circuit. If you are drawing your own schematic, you can eliminate quite a few lines by checking out some of the variations on those connections. Eliminating a few lines can make quite a difference on the appearance of the finished schematic, and, of course, in the ease of following it.

For instance, if the receiver you're drawing a schematic for has a series filament, just draw the string near the power supply. Designate each tube number and filament prong number in the proper order, and be sure to include any resistors or panel lights, where they are applicable.

It is even easier to draw the filament designations for transformer-type sets. While some schematics have the entire parallel filament connections just to the right of the power transformer, they may or may not show the symbol for the filament. An easier way, I think, is just to designate the filament winding with an X or F where

it comes off the secondary of the transformer, and draw the filament and pin numbers up in the tube symbol. Either way, you can see all the drawing you saved by not drawing lines from the filament source to each tube that appears in the schematic. And how much clearer the resulting diagram is.

Standardizing your drawing

A few methods are used to represent wires between connections and components. Looking at the schematics, you can see that it would be impossible to draw all of the lines without crossing over some. It has to be made clear whether or not the crossed lines indicate a connection. The method used was not standard in older schematics and is sometimes indicated in the corner of the schematic along with other information that everyone wasn't able to agree on.

When drawing your own schematics, adopt a standard for yourself. I use the little bridge for lines that don't connect and a little circle at a junction to indicate a connection—that method leaves no doubt. Various voltages are usually indicated as they come off the power transformer. All connections that go to a certain voltage are indicated by a small arrow and

Be an FCC LICENSED ELECTRONIC TECHNICIAN!



Earn up to \$30 an hour and more!

Learn at home in spare time. No previous experience needed.

No costly school. No commuting to class. The Original Home-Study course prepares you for the "FCC Commercial Radiotelephone License". This valuable license is your "ticket" to thousands of exciting jobs in Communications, Radio-TV, Microwave, Computers, Radar, Avionics and more! You don't need a college degree to qualify, but you do need an FCC License.

No Need to Quit Your Job or Go To School
This proven course is easy, fast and low cost! **GUARANTEED PASS** - You get your FCC License or money refunded. **Send for FREE facts now. MAIL COUPON TODAY!**

COMMAND PRODUCTIONS
FCC LICENSE TRAINING, Dept. 90
P.O. Box 2223, San Francisco, CA 94126

Please rush **FREE** details immediately!

NAME _____
ADDRESS _____
CITY _____ STATE _____ ZIP _____

the voltage. Otherwise, the schematic would be a maze of lines and it would be impossible to trace a circuit. When drawing your sche-

R-E Service Admart

Rates: Ads are 2 1/4" x 2 7/8". One insertion \$825. Six insertions \$800 each. Twelve insertions \$775. each. Closing date same as regular rate card. Send order with remittance to **Service Admart**, Radio-Electronics Magazine, 500-B Bi-County Blvd., Farmingdale, NY 11735. Direct telephone inquiries to Arline Fishman, area code-516-293-3000. **Only 100% Service ads are accepted for this Admart.**

INTRODUCTION TO VCR REPAIR ON VIDEO TAPE

There is no other tape like ours on the market.

You will learn how the video signal is processed in both record and playback. You will also learn how the servo systems control the video drum and capstan motor. **To save time & money on your VCR repairs, order your tape now!**

Price \$29.95 + \$3.00

Postage or Simply call: (513) 548-6113
Master Card and Visa are accepted.

UCANDO

VCR EDUCATIONAL PRODUCTS CO.
P.O. BOX 386
GREENVILLE, OHIO 45331

ELEVEN-PIECE RATCHET TOOL KIT



Includes reversible ratchet handle, extension bar, six bits, two precision screwdrivers, and a cutter. Comes in fitted case. Get one for your shop, another for your car, another for your tool kit. To order send **\$10.00 plus \$1.75 for shipping** in the U.S. to **Electronic Technology Today Inc., P.O. Box 240, Massapequa Park, NY 11762-0240.**

POCKET BATTERY TESTER



Tests all 1.5-volt cells including A, AA, AAA, C, and D. Also checks miniature watch and calculator batteries. Special side connector provides rapid check of square 9-volt batteries. Positive meter reading shows "GOOD, LOW, REPLACE". **\$6.00 each. Two for \$10.00.** Add \$1.75 for UPS. Send check to **Electronic Technology Today Inc., P.O. Box 240, Massapequa Park, NY 11762.**

CIRCLE 202 ON FREE INFORMATION CARD

NEW SUPER LONG PLAY TAPE RECORDERS

12 Hour Model — \$105.00*
USES D-120 TAPE

Modified Panasonic Slimline, high quality, AC-DC Recorders provide 6 continuous hours of quality recording & playback on each side of cassette for a total of 12 hours.

Built-in features include:
• Voice level control
• Digital counter, etc. TDK DC 120 Cassette Furnished.

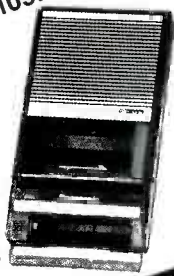

PHONE RECORDING ADAPTER

Records calls automatically. All Solid state connects to your telephone jack and tape recorder. Starts recording when phone is lifted. Stops when you hang up.



VOX VOICE ACTIVATED CONTROL SWITCH
Solid state. Self contained. Adjustable sensitivity. Voices or other sounds automatically activate and control recorder. Uses either recorder or remote mike.



*Add for ship & hdlg. Phone Adapter & Vox \$1.50 ea. Recorders \$4.00 ea. Cal. Res. add tax. Mail order. VISA, M.C. COD's OK. Money Back Guarantee. Qty. disc. avail.. Dealer Inquiries invited. Free data.
AMC SALES INC. Dept A 9 35 Lubec St., Box 928, Downey, CA (213) 904-21 Phone 869-8519

CIRCLE 108 ON FREE INFORMATION CARD

matic, be sure to identify all parts, such as R1 and C1, and the component's value can be limited elsewhere on the schematic

ATTENTION! ELECTRONICS TECHNICIANS

EARN YOUR **B.S.E.E. DEGREE**



THROUGH HOME STUDY

Our New and Highly Effective Advanced-Placement Program for experienced Electronic Technicians grants credit for previous Schooling and Professional Experience, and can greatly reduce the time required to complete Program and reach graduation. No residence schooling required for qualified Electronic Technicians. Through this Special Program you can pull all of the loose ends of your electronics background together and earn your B.S.E.E. Degree. Upgrade your status and pay to the Engineering Level. Advance Rapidly! Many finish in 12 months or less. Students and graduates in all 50 States and throughout the World. Established Over 40 Years! Write for free Descriptive Literature.

COOK'S INSTITUTE OF ELECTRONICS ENGINEERING

4251 CYPRESS DRIVE JACKSON, MISSISSIPPI 39212

CIRCLE 58 ON FREE INFORMATION CARD

Originally, the wiring in your antique radio was probably color coded, and if the colors didn't fade, you can make a note of them on

your schematic. It doesn't matter whether or not they conform to any standard color code, although wires that conform to standard codes are a big help.

The radio companies that did conform to a wire color code in the 1930's used the following: For conductors that are used in one circuit only, A+ : yellow; A- : black with a yellow line; B+ : red and/or maroon; B- : black with a red line; C+ : green; C- : black and green. The loudspeaker connections were brown and black with a brown line.

Now that you have completed the schematic for your antique radio, it should be a big help in making any future repairs. That is assuming you don't forget to make a note of all repairs and circuit changes on your schematic.

Did you ever find a parched, rolled-up piece of paper with some diagram on it inside your antique radio? Hieroglyphics? No, it was just a little note left by a competent radioman of long ago. He wanted to be sure that future antique-radio collectors would be aware of a circuit change he made. If you follow his lead, you'll make things easier on future owners, or yourself, if further servicing is ever needed.

R-E

SHORTWAVE

continued from page 79

cated near Okeechobee, Florida. Its programs are beamed to the Americas, Europe, Africa, the Middle East, and Asia, in nine languages—English, French, Spanish, German, Portuguese, Arabic, Russian, Mandarin, and Hindi.

WYFR is the only privately owned U.S. broadcaster with an exchange agreement with another country. It currently relays programs from the Republic of China to east and west Canada, Mexico, and Central and South America. In exchange, WYFR programs in English, Russian, Hindi, and Mandarin are relayed by the Broadcasting Corporation of China facilities near Taipei, Taiwan.

WYFR was the first U.S. broadcaster to operate in the 13-MHz band, commencing operations on 13695 kHz last winter. A complete program and frequency schedule can be obtained by writing WYFR, Oakland, CA 94621. R-E

AUDIO UPDATE

continued from page 77

duced from 20 to 14 dB and the signal is equalized to optimize psychoacoustic masking, very much as is done in the Dolby home noise-reduction systems. In addition, the polarity of the quadrature subcarrier has been inverted, which apparently eliminates inter-

ference problems. Otherwise, the basic operating principles of FMX remain the same, although the 6-dB reduction in compression implies a slight scaling down of the original noise-reduction claims.

FMX appears bug-free and the rush to it seems underway. It is estimated that at least 14 stations will be broadcasting FMX-encoded programs by this fall. A supplier already has off-the-shelf FMX encoders available. R-E

CABLE-TV SIGNAL ELIMINATOR

ELIMINATE A CHANNEL

that you find unsuitable for family viewing, but is poorly scrambled by your cable company.

or

CLEAR UP A CHANNEL

that presently contains severe interference, by ELIMINATING whatever signal is causing this.

NOTE: If picture and sound are equally affected, this IS interference and CAN be removed by our product. If only picture is affected, this usually IS NOT interference and CANNOT be removed by our product.

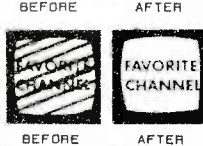

\$30 each

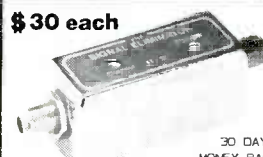

30 DAY
MONEY-BACK
GUARANTEE

* All models in stock
* Fast, free shipping
* One year warranty
* Quantity discounts to 50%
TO ORDER, SEND CHECK OR MONEY ORDER TO:

WORKS ON CABLE TV OR BROADCAST TV

EXTERNAL ADJUSTMENTS ALLOW PRECISE TUNING TO ANY FREQUENCY REQUIRED
THREE MODELS AVAILABLE:

MODEL 26-Tuneable to channels 2 thru 6 [54-108 Mhz]

MODEL 1422-Tuneable to channels 14(A) thru 22(I) [120-174 Mhz]

MODEL 713-Tuneable to channels 7 thru 13 [174-216 Mhz]

STAR CIRCUITS - (DEPT. F)

P.O. BOX 8067

PENBROKE PINES, FLORIDA 33084

Try the Radio Electronics

bulletin board
system

(RE-BBS)
516-293-2283

The more you use it the more
useful it becomes.

We support 300 and 1200 baud
operation.

Parameters: 8N1 (8 data bits, no
parity, 1 stop bit) or 7E1 (7 data
bits, even parity, 1 stop bit).

Add yourself to our user files to
increase your access.

Communicate with other R-E
readers.

Leave your comments on R-E with
the SYSOP.

RE-BBS
516-293-2283

Get A Complete Course In

ELECTRONIC ENGINEERING

8 volumes, over 2000 pages,
including all necessary math and
physics. 29 examinations to help
you gauge your personal pro-
gress. A truly great learning
experience.

Prepare now to take advan-
tage of the growing demand for
people able to work at the engin-
eering level.

Ask for our brochure giving
complete details of content. Use
your free information card num-
ber, or write us directly. \$99.95,
Postage Included. Satisfaction
guaranteed or money refunded.



**Banner
Technical
Books, Inc.**

1203 Grant Ave.
Rockford, IL 61103

CIRCLE 186 ON FREE INFORMATION CARD

TELEPHONE SCRAMBLER

Installs on most phones
including cellular



Easily installed between phones to scramble com-
munication, including tone, wireless and cellular.
Scrambler makes it impossible to intercept or
decode. Solid state unit has 13000 selectable
codes. Excellent sound quality allows immediate
voice recognition. Fully self-contained and easy to
use. Small, light weight and portable. Two units
required. Only \$369.00 each plus \$4.00 shipping
and handling.

OTHER AMC PRODUCTS 12 hr. modified
Panasonic Recorder, Brief Case Recorder, Tele-
phone Recording Adaptor, VOX Switch, Micro
Recorder, Tie clip mike, VOX activated micros,
Wired mikes, Transmitter detectors, etc. Send for
FREE data. Mail order, VISA, M/C, C.O.D. ok.,
Cal. Res. add tax.

AMC SALES INC., Dept. A • (213) 869-8519
9335 Lubec St., Box 928, Downey, CA 90241

CIRCLE 176 ON FREE INFORMATION CARD

Radio-Electronics mini-ADS



ZENITH SSAVI UHF input from \$199, ch. 3 input \$229, reconditioned. UHF SSAVI project handbook \$6.50 ppd. Used Sylvania 4040s \$169. N-12s & MLD-1200s. Converters, amplifiers & accessories. Satellite systems. Radar speed guns for car/boat racing, bowling, skiing, baseball, etc., from \$275 used. Professional police models. Multi-line business telephone systems from \$1395. Catalog \$1. **AIS SATELLITE, INC.**, P.O. Box 1226-J, Dublin, PA 18917. 215-453-1400 or 215-249-9411.

CIRCLE 81 ON FREE INFORMATION CARD

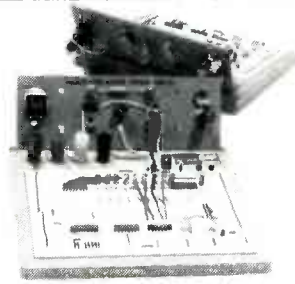

X-TRA EDGE SOLDERLESS BREAD-BOARDS. Four (4) models, each includes the Multi-use Edge Panel for mounting components which don't fit the 0.1" DIP size bread-board spacing. Transistors, SCRs, Triacs, Regulators, Heat Sinks, Switches, Lamps, Fuses, Pots, Buzzers, etc. Models include 810, 1620, 2230 and 2940 tie-points. Priced at \$16.95, \$34.95, \$49.95 and \$59.95. **CHENESKO PRODUCTS**, 21 Maple St., Centereach, NY 11720, 516-736-7977, Fax: 516-732-4650

CIRCLE 79 ON FREE INFORMATION CARD

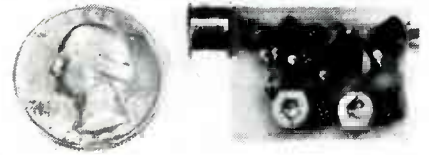

SIMPLY SNAP THE WAT-50 MINIATURE FM TRANSMITTER on top of a 9v battery and hear every sound in an entire house up to 1 mile away! Adjustable from 70-130 MHZ. Use with any FM radio. Complete kit \$29.95 + \$1.50 S + H. Free shipping on 2 or more! COD add \$4. Call or send VISA, MC, MO. **DECO INDUSTRIES**, Box 607, Bedford Hills, NY 10507. (914) 232-3878.

CIRCLE 127 ON FREE INFORMATION CARD

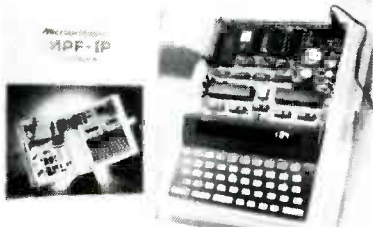

MICROPROFESSOR 1-P—LEARN ASSEMBLY LANGUAGE PROGRAMMING Z-80 C.P.U. 8 bit trainer. 158 instruction set. Teaches essential programming and hardware skills for technicians, trouble-shooters, circuit designers, system architects and engineers. Industrial controller. Additional languages-BASIC and FORTH. Fully expandable with I/O, EPROM Programmer, Printer and Accessories. Three manuals included. \$199.95 plus \$7.50 shipping. **ETRONIX Dept. RE 688**, 5326 Ninth N.E., Seattle, WA 98105, 1-800-426-1044.

CIRCLE 111 ON FREE INFORMATION CARD



PANASONIC CABLE CONVERTERS, Wholesale and Retail. Scientific Atlanta and Pioneer Cable Converters in stock. Panasonic model 140N 68 channel converter \$79.95, Panasonic Amplified Video Control Switch Model VCS-1 \$59.95. Scientific Atlanta Brand new Model #8528 550MHZ 80 Channels Converter \$89.95. Video Corrector (MACRO, COPYGUARD, DIGITAL) ENHANCER \$89.95. We ship to Puerto Rico, Caribbean countries, & So. Amer. Write or call **BLUE STAR IND.**, 4712 AVE. N, Dept 105, Brooklyn, NY 11234. Phone (718) 258-9495.

CIRCLE 85 ON FREE INFORMATION CARD

CALL NOW AND RESERVE YOUR SPACE

- 6 x rate \$815.00 per each insertion.
- Fast reader service cycle.
- Short lead time for the placement of ads.
- We typeset and layout the ad at no additional charge.

Call 516-293-3000 to reserve space. Ask for Arline Fishman. Limited number of pages available. Mail materials to: mini-ADS, RADIO-ELECTRONICS, 500-B Bi-County Blvd., Farmingdale, NY 11735.



THE MODEL WTT-20 IS ONLY THE SIZE OF A DIME, yet transmits both sides of a telephone conversation to any FM radio with crystal clarity. Telephone line powered - never needs a battery! Up to 1/4 mile range. Adjustable from 70-130 MHZ. Complete kit \$29.95 + \$1.50 S + H. Free Shipping on 2 or more! COD add \$4. Call or send VISA, MC, MO. **DECO INDUSTRIES**, Box 607, Bedford Hills, NY 10507. (914) 232-3878.

CIRCLE 127 ON FREE INFORMATION CARD



RADAR SPEED GUNS. Professional units for clocking speeds in baseball, car & boat racing, etc., starting at \$275 used, \$350 reconditioned. Moving and stationary units available with dual displays. All units are road tested and have 30-day warranties. Catalog \$1. Complete line of TV accessories. Multi-line key business telephone systems from \$1395. **AIS SATELLITE, INC.**, P.O. Box 1226-R, Dublin, PA 18917. 215-453-1400 or 215-249-9411.

CIRCLE 192 ON FREE INFORMATION CARD

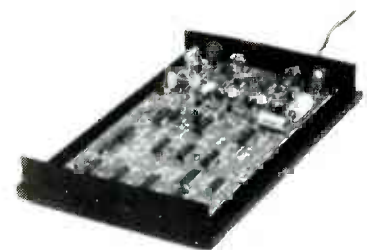

TRI-MODE DESCRAMBLER PARTS Original parts as called up in Radio Electronics Feb 1987 article on tri-mode descrambling. Includes pc board, ac adaptor, resistors, capacitors, diodes, pots, transistors, IC's, LED's, toko coil and Plessey SAW filler. Article included. \$59 plus \$2.50 shipping. **ELECTRONIC PARTS**, Box 276, Alburg, VT 05440 (514) 739-9328.

CIRCLE 80 ON FREE INFORMATION CARD

COMPUTER DIGEST

VOL. 5 NO. 6 JUNE 1988

A NEW KIND OF MAGAZINE FOR ELECTRONICS PROFESSIONALS

MICROCOMPUTER MICE

A market roundup

A
GERNSBACK
PUBLICATION

Page 87

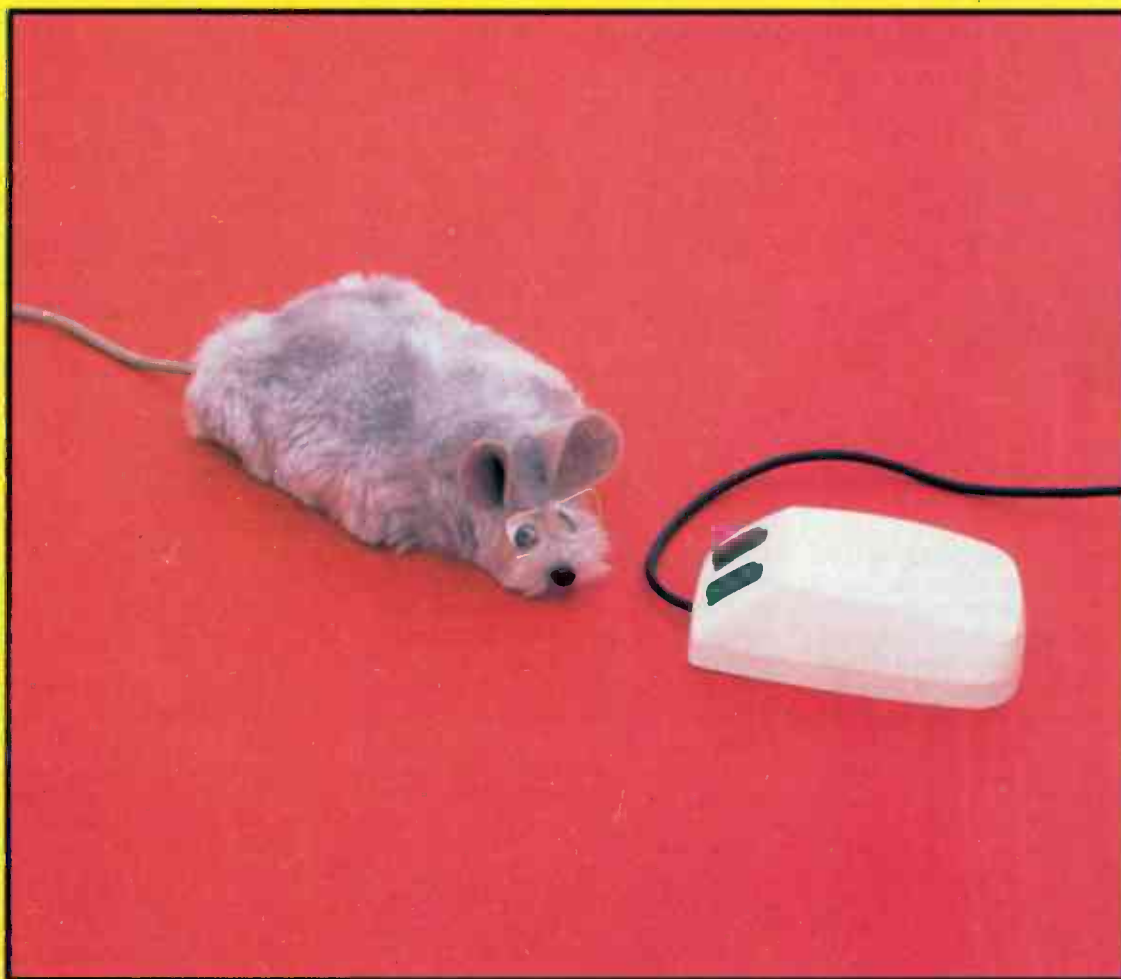

CD CLASSROOM

Dynamic RAM in the PT-68K

Page 93

MULTIMODE VIDEO GRAPHICS

Hands-on look at Orchid's Designer VGA Page 86

EDITOR'S WORK- BENCH

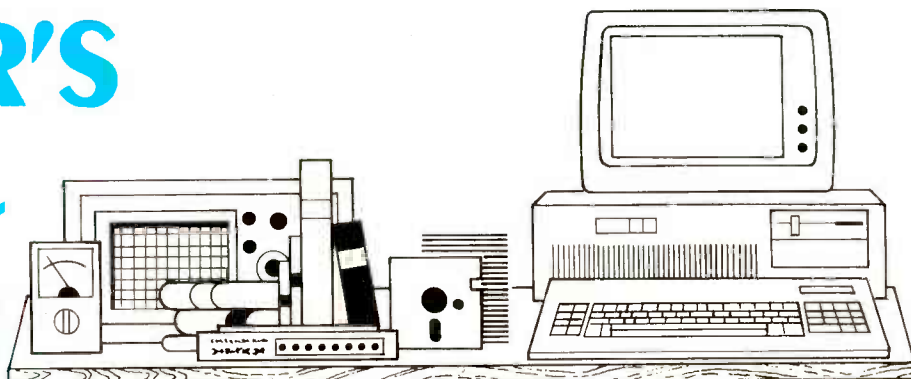

Orchid's Designer VGA

Video standards for the IBM family have come a long way since the lowly Color/Graphics adapter. At maximum resolution (640 × 200) only two colors are available; at lower resolution (320 × 200) a maximum of four colors are available. In text modes, a total of 16 colors are available.

The EGA standard raises the stakes somewhat, permitting 16 colors (of a possible 64) on a 640 × 350 screen. But that's still unsatisfactory; consequently, most of the major display-adapter manufacturers came out with higher resolution formats (often 640 × 480 with 16 colors) that, although providing more resolution, are incompatible with each other. Consequently, special software drivers had to be written by each hardware manufacturer for each program it

wanted to support. Obviously, that's economically unattractive.

That all changed last year when IBM introduced its new line of computers. Not only were new operating systems (DOS 3.30 and OS/2) and a new expansion bus (the Micro Channel) introduced, so was a new video standard: the VGA (Video Graphics Array). It's built right on the motherboard of the high-end PS/2 machines, and it's available as an option for the low-end machines. In addition, IBM offers an adapter that provides VGA capabilities for traditional bus machines (PC's, XT's, AT's, and clones). Of course all the major display-adapter manufacturers are racing to provide similar capabilities.

VGA provides both enhanced resolution and a greater number of colors than previous modes, although not necessarily both simultaneously. The new and enhanced modes with corresponding numbers of colors are summarized in Table 1. Modes 0–7 are enhanced versions of previous C/GA and monochrome modes; Modes 11–13 are the most interesting new modes.

It's important to understand that the number of colors available in a specific mode is a fraction of a total of 256K possible colors. For example, Mode 13h allows 256 colors out of a total of 256K (262,144) different colors. Although resolution in that mode is very low (C/GA level), the sheer number of colors allows for striking

possibilities. (See the August 1987 cover of **Computer Digest** for one example, and IBM's PS/2 tutorials for others.)

Of course, you can't display 256K colors on a C/GA monitor, or even on an EGA monitor. One of IBM's new analog monitors is required, or else a NEC Multisync (or compatible) will do the job. With an older multi-frequency monitor, you may have to fiddle with the knobs (especially vertical hold and size) when changing between an 80 × 25 text mode and a high-resolution text or graphics mode. The IBM monitors are single-frequency analog types, available in monochrome and color; the relatively inexpensive monochrome monitor displays colors in various shades of gray.

The Designer VGA

Orchid Technology, maker of accelerator cards, networking products, and video adapters, is one of the first companies to introduce a multi-mode VGA adapter for traditional-bus machines. The Designer VGA provides compatibility with all previous video standards: C/GA, EGA, Hercules monochrome, and all VGA modes. Through separate ports, the board can drive TTL (monochrome or EGA) or analog (Multisync or fixed-frequency analog) monitors. It's a short card that will fit in an eight-bit slot in any machine with an old-style bus.

We tested a Designer VGA card in an AST Premium/286, driving a NEC Multisync monitor in both TTL and analog modes. (A special adapter cable is required to plug older Multisync's into the new 15-pin VGA port connector.) In EGA (TTL) mode, the board flawlessly ran the following software: AutoCAD 9.0, AutoSketch, Windows 2.0, PageMaker 1.0, Excel, Dr. Halo III, and IBM's version of OS/2. In VGA mode, it flawlessly ran Dr. Halo and OS/2. In addition, special drivers are

continued on page 98

TABLE 1—VGA MODES AND COLORS

Mode	Vertical Resolution	Horizontal Resolution	Colors	Type
0h, 1h	360	400	16	Text
2h, 3h	720	400	16	Text
07h	720	400	2	Text
11h	640	480	2	Graphic
12h	640	480	16	Graphic
13h	320	200	256	Graphic

MICROCOMPUTING MICE

Mice demystified

JEFF HOLTZMAN

The mouse is invading! In programs ranging from drafting (AutoCAD, AutoSketch) to drawing (Dr. Halo, PC Paintbrush), from spreadsheet (Excel) to word processor (Word)—not to mention operating environments (DESQview, Windows)—they're everywhere! More than half a dozen manufacturers are hawking their wares, and several more are hawking alternate technologies that in some way hope to alleviate one or more weak points of the mouse. In this article, we'll examine the basics of how mice work, and then examine some popular devices.

Types of mice

There are three basic mouse types: mechanical, optical, and wheel. The most common is the mechanical, shown in Fig. 1. It has a roller ball that drives two pressure rollers mounted at right angles to one another, one each corresponding to the X and Y dimensions.

The pressure rollers in turn drive two encoder wheels. In a purely mechanical mouse, the encoder wheels have contact points around the circumference that serve to make and break an electric circuit. In an opto-mechanical mouse, slits in the encoder wheel make and break an optical circuit (i.e., an LED/photodetector pair). In either case, signal-shaping circuitry cleans up the signals and converts them to a form digestible by a computer.

The wheel mouse is quite similar to the mechanical mouse, except that there is no wheel. Instead, the shafts from the encoder wheels terminate in small wheels that contact the table directly.

The distinguishing feature of the optical mouse is that it has no moving parts. Instead, a pair of LED's shine through the case of the mouse. Their beams are reflected by a specially lined pad and are then detected by photodetectors in the mouse. As with the mechanical mouse, those raw signals are then cleaned up and converted for computer use. Because they have no moving parts, optical mice are more reliable and easier to maintain.

As for alternate devices, the most popular is the trackball, which can be viewed as just a mouse lying on its back. Instead of contacting a table, the ball contacts your hand. Internally, either mechanical or opto-mechanical technology can be used to decode motion.

Digitizing tablets can also emulate mice, through a combination of both hardware and software. For example, Keytronic's KB5153 keyboard contains what amounts to a miniature high-resolution digitizing tablet. Output from the keypad is transmitted along with the usual scan codes from the keyboard; a special software driver separates keyboard codes from tablet codes, and can translate the latter into equivalent mouse codes if desired.

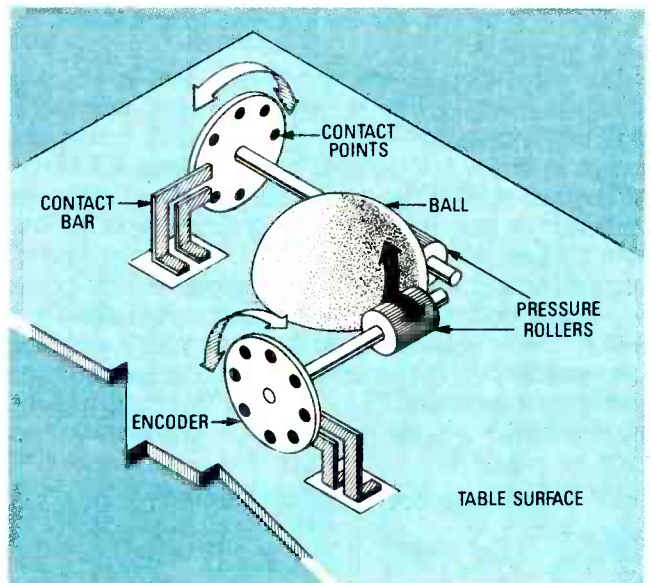
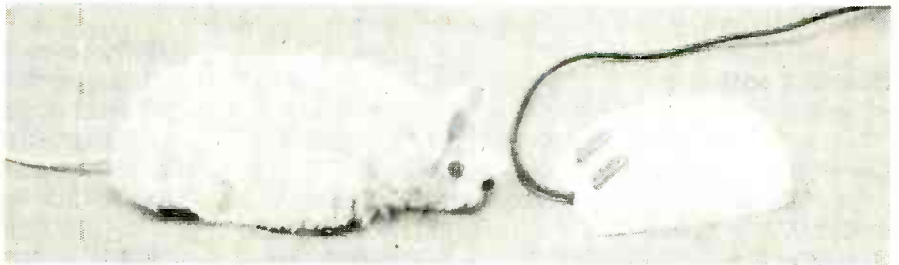

FIG. 1—Inside a mechanical mouse. The roller ball drives two pressure rollers mounted at right angles to each other.

Number of buttons

Among human-interface designers, discussions of the optimum number of buttons on a mouse is akin to arguing about the number of angels that can fit on the head of a pin. The arguments become heated, but most real-world software is written to use only one button (occasionally two). For example, even though the Microsoft mouse has two buttons, Windows uses only one. A few mice have three buttons, but there is almost no commercial software that uses all three.

Interface hardware

Whatever the underlying technology, the mouse must have a way to get signals to your PC. There are two basic interface techniques: serial and bus. A serial mouse connects directly to any standard RS-232 port; a bus mouse has its own interface card. (Trackballs are generally serial devices.)

It is claimed that a bus mouse provides better response, but unless you're in the habit of racing your mouse across your desk at full speed, you're not likely to notice any difference. So choose the type of mouse depending on whether you have a free serial port or a free slot. The only other thing to keep in mind is that, when installing a bus mouse, you'll have to select an interrupt level that is not used by other devices in your PC.

Microsoft has an additional mouse interface, called the

InPort. The InPort is a special type of serial interface that is available on Microsoft's Mach 10 and PC Technologies' Rainbow Plus accelerator cards, and a few others. The InPort connector is non-standard, so you cannot plug an InPort mouse into a standard serial-port connector.

Interface software

Several protocols exist by which a mouse may communicate with the host PC, including Summagraphics Bit Pad One (binary and ASCII protocols), Retrographics RG-512, three-byte relative, Houston Instruments HiPad, five-byte relative (Mouse Systems), Tektronics Plot 10, Microsoft, USI OptoMouse, Hitachi Tiger, and others. As the names suggest, some of those protocols were originally developed for digitizing tablets, but are available as emulations for some mice.

The most popular protocol, one that is at least provided as an option by almost all mice and many digitizing tablets for PC's, is the Microsoft format. As shown in Table 1, it consists of three seven-bit bytes, transmitted at 1200 baud, with no parity, and with one start and one stop bit. The most-significant bit of the first byte is a sync bit that indicates the beginning of a transmission frame. The next two bits indicate the state of the two mouse buttons; a zero bit corresponds to a pressed switch. The next two bits are the high-order Y-axis bits, followed by the high-order X-axis bits. The second byte contains the remaining X bits, and the third byte contains the remaining Y bits. The high-order bits of bytes two and three are not used.

TABLE 1—MICROSOFT MOUSE PROTOCOL

Byte Bit	6	5	4	3	2	1	0
1	1	S1	S2	Y7	Y6	X7	X6
2	0	X5	X4	X3	X2	X1	X0
3	0	Y5	Y4	Y3	Y2	Y1	Y0

Normally, you needn't concern yourself with the software interface protocol. Name-brand mice (Microsoft, of course, as well as Logitech and Mouse Systems) are supported directly in their own format by most major

software packages; almost invariably they include Microsoft emulation modes as well. You should be safe buying an off-brand mouse (or an alternate device), assuming it can emulate the Microsoft protocol competently.

Utility software

Using a mouse with Windows or AutoCAD is a snap—but what about all the other programs that don't know mice from lice? Many mice now include special programs that let you build your own mouse interface for your favorite application program.

To generate a mouse-based menu interface, you write a program using your favorite ASCII text editor, compile it, and then run it before running your application. In the application, special menus pop up depending on which buttons you push, what's displayed on the screen, etc. With careful thought, you can add a complete menu interface to just about any program that operates in text mode. The menu-programming language is simple to use, easy to master, and easy to experiment with. Microsoft's menu language is something of a standard; compilers made by other companies (Logitech for one) can compile Microsoft menu files directly.

Maintenance

Unless you are a total slob, mouse maintenance is minimal or non-existent. One claimed advantage of optical over mechanical mice is that no cleaning is ever required. That may be true, but cleaning a mechanical mouse is a 30-second procedure that must be performed only a few times a year.

Product evaluations

What follows are our experiences installing and using more than half a dozen different mice and other devices. Although there are differences among them, and we certainly have our favorites, not one has serious defects, and every one is well built. Features are summarized in Table 2. A serial version of each device was installed on an IBM PC XT with a 12-MHz BreakThru 286 accelerator card (made by PCSG) and tested with the following software: Microsoft Windows 2.0, DesqView 2.0, Auto-

TABLE 2—FEATURE COMPARISON CHART

	Fulcrum Trackball Plus	Numonics Manager Mouse Cordless	Logitech Mouse	Microsoft Mouse	Keytronic KB5153	PC Mouse
Length (inches)	4.5	3.6	4.8	4.0	3.5	3.8
Width (inches)	5.8	2.4	2.8	2.1	3.5	2.6
Height (inches)	1.8	1.1	1.0	1.2	1.3	1.0
External power	Y	Y	N	N	N	N
Battery	Y	Y	N	N	N	N
Microsoft emulation	Y	Y	Y	Y	Y	N
Total emulations	10	3	3	1	1	1
Cable length (inches)	48	40*	72	90	72	60
Technology	O	M	OM	M	M	O
Number of buttons	6	3	3	2	2	3
Menu software	N	N	Y	N	N	Y
Other utility software	N	Y	Y	Y	Y	Y
RAM used by basic driver (K)	8	8	10	10	6	7
Software version tested	6.02	6.11	3.41	6.11	3.0	5.03
Price	\$95	\$199	\$119	\$150	\$249	\$149

*With charging cable

Sketch, and Dr. Halo. Except as noted, all devices performed adequately with each program. Reviews are presented alphabetically by manufacturer.

Fulcrum

To some, a big disadvantage of the mouse is that you must maintain a flat, fairly clean area on your desk in which to operate the device. The trackball overcomes that problem; you can set the trackball's housing on just about anything (including your lap) and still obtain acceptable results. In addition, sometimes you run off the edge of the desk when using a mouse, after which you must pick it up, set it down, and then continue working. That never happens with a trackball.

Fulcrum's Trackball Plus (shown in Fig. 2) has six buttons and emulates nearly all standard protocols (including Microsoft). You can set the emulation protocol using either a software driver or by pressing various combinations of buttons.

There is a potential problem with "dragging," the process of pressing a button while moving a mouse. Because of the mechanical arrangement, dragging can be difficult or impossible with a trackball. Fulcrum solves the problem by dedicating the fourth button to initiating a drag. First press it, followed by the desired button. The trackball will continue responding as if that button is depressed until you press another button.

The fifth button is a dedicated "alternate cursor" switch, useful in AutoCAD for getting at the menus without actually moving the drawing cursor from its current position.

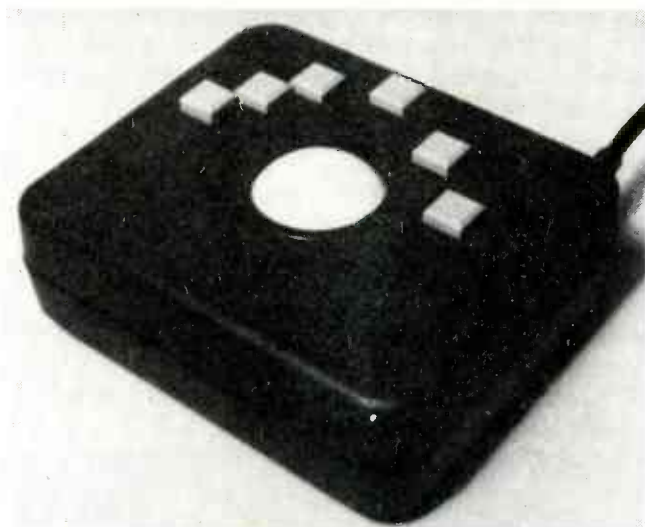

FIG. 2—The Fulcrum Trackball Plus

The trackball itself has a very nice feel. But because of the height of the enclosure, there is no support for your wrist, so your arm may get tired. The buttons generate a nice click when pressed, and they have a stiff feel that is almost too stiff. The interface cable is somewhat short, and due to the non-symmetric layout of the six buttons, the device is definitely biased toward right-handed users. But you needn't maintain a clear space on your desk to use the Trackball Plus, and the trackball itself allows very precise cursor positioning.

Keytronic

The KB5153 keyboard was originally reviewed in the

July 1987 issue, where we concentrated on its function as a keyboard. Since then, Keytronic has released new software for the keyboard that provides better support for graphics programs.

The keyboard itself is laid out in the AT style, with the Escape key appearing in the numeric keypad. Next to the numeric keys is the pad itself (shown in Fig. 3), which measures about 3½ inches on a side. The pad has a resolution of about .001", about five to ten times that of most mice.

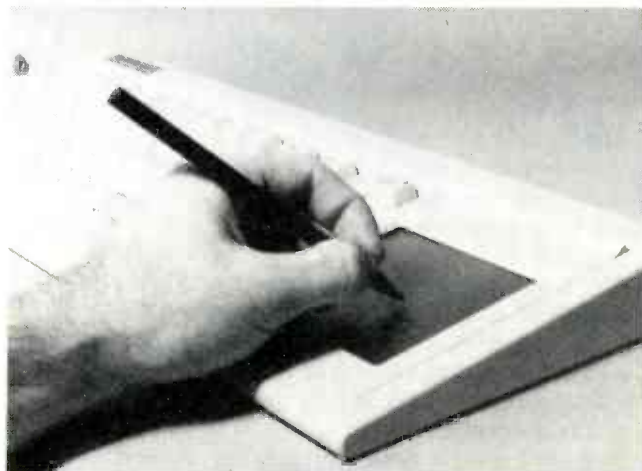

FIG. 3—The Keytronic KB5153

The pad is programmable and may be used in several modes, including Function (wherein areas of the pad function as keys that are user-programmable), Cursor (wherein the pad functions like the cursor keys), Mouse (wherein the pad emulates a Microsoft mouse), Graphics (wherein the pad emulates a digitizing tablet), and various combinations of the above.

Separate programs are supplied to use the pad as a mouse under DOS and under Windows. Installing the Windows driver is slightly difficult, because the installation instructions refer to an old version of the program (1.0), and because Windows itself is "cantankerous." After getting through the installation, however, the pad works well. Special drivers and plastic overlays are available for use with PageMaker and Ventura Publisher. By touching the plastic stylus to various parts of the pad, you can open and save files and perform other common functions. Other parts of the pad function (simultaneously) as a "drawing" area for mouse emulation.

Mouse emulation works fairly well, but, depending on your software, you may need to experiment with some of the emulation settings (in consultation with Keytronics' technical support personnel, who are available by toll-free telephone). The only oddity is that you must get used to working with both hands, because the mouse buttons are simulated by pressing keyboard keys.

Since our original review, Keytronic has decreased the price and increased the functionality of the KB5153. It needs neither a slot nor a serial port, so in its present incarnation, it's a winner. Left-handers watch out, though; the pad is contained in the right side of the keyboard.

Logitech

Although boxy looking (as shown in Fig. 4), Logitech's mouse has an excellent feel, good emulation, and good utility software. It is available in serial, bus, and PS/2

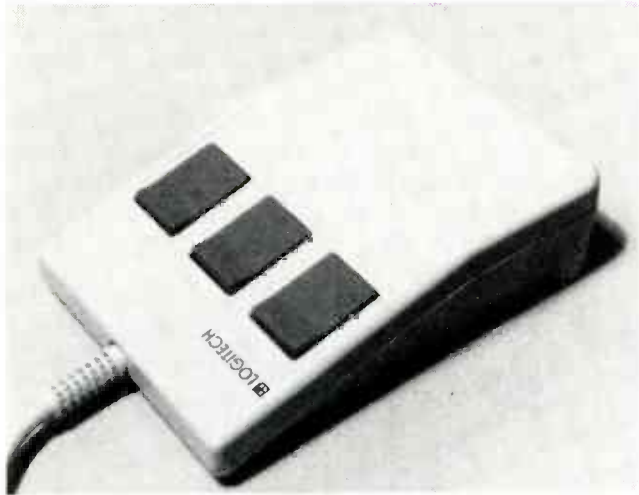

FIG. 4—The Logitech Mouse

versions, and may also be purchased with one of several applications programs (desktop publishing, CAD, draw/paint). In addition, a high-resolution version of the mouse is also available for use with large-screen monitors. (The standard model is sufficient for use with EGA, Hercules, and similar adapters.)

Logitech's mouse driver can emulate several types of mice; a separate program called CLICK allows you to adjust mouse sensitivity on the fly, and also attaches itself to DOS in such a way that it knows when you load applications for which you have defined mouse menus. When you do, it loads the appropriate menus for you, followed by your application.

Like the new Microsoft mouse, the Logitech mouse buttons have audible and tactile feedback that is just right. Unlike that mouse, however, the Logitech mouse's center of gravity is near the rear of the housing, which makes fingertip control slightly more difficult than with the Microsoft. But just a little.

Unlike Microsoft, Logitech includes menu-generating software at no extra cost, as well as pre-written menus for quite a few applications programs. In addition, a competent mouse-based multi-window text editor (called Point) is included; Logitech claims to use it for all internal program development.

Microsoft

Before release of the new mouse (shown in Fig. 5), the feel of the old mouse was good, and on a par with that of the competition. However, the feel of the new mouse overshadows the old mouse, as well as the competition. The buttons are firm but not stiff, they provide audible as well as tactile feedback (unlike the old mouse), and, because the ball has been moved forward within the mouse's housing, you can control movement of the mouse with your fingertips, almost like a trackball. (The old Microsoft mouse is no longer in production, but may still be available from some distributors.) The Microsoft mouse is available in bus, serial-port, and InPort configurations. (The serial version of the new mouse also includes an adapter for using the mouse on a PS/2 machine.) They are also available bundled with various paint and CAD packages.

Operation of the control software is simple. You needn't specify which port the serial mouse is connected



FIG. 5—The Microsoft Mouse

to; the software will find it. A separate memory-resident program (CPANEL.COM) allows you to adjust motion sensitivity on the fly. A demonstration program allows you to "play" a piano by moving the mouse and clicking on the screen representation of the white and black keys. Several menu programs are included (for Lotus 1-2-3, IBM DisplayWrite, MultiMate, WordStar, etc.); to write your own programs, you'll need a copy of the *Microsoft Mouse Programmer's Reference Guide*, an extra-cost (\$25) purchase. A very capable draw/paint program (Microsoft Paintbrush) is included with each mouse.

The only disadvantage of the new Microsoft mouse is that you must pay extra for the menuing software and documentation. However, pre-written mouse menus are included for several packages, including WordStar, Lotus 1-2-3, and others.

Mouse Systems

The PC Mouse is an optical mouse that glides over a specially marked pad (shown in Fig. 6) that measures about 8" x 10". You might think that using the pad would be inconvenient, but in some ways the opposite is true. For example, if you don't use your mouse very often, it tends to get buried. Then, when you are ready to use the mouse, you have to dig it out and clear a space for it. With the PC Mouse, you could simply drop the pad on top of the pile and get right to work.

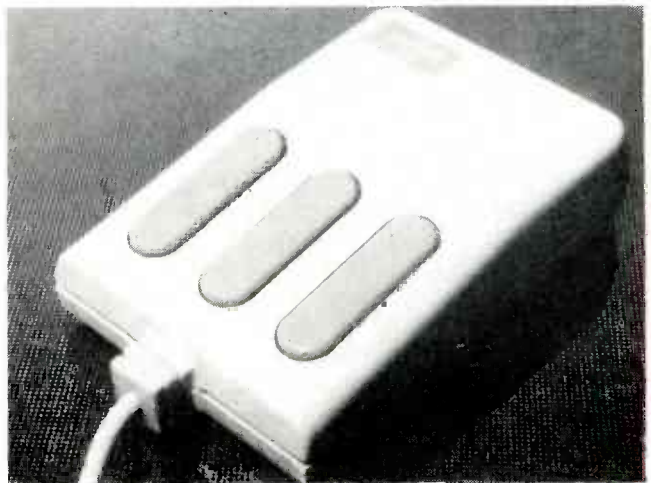

FIG. 6—The PC Mouse

The mouse itself resembles the Logitech mouse in shape, but is only slightly harder to use because the felt pads it rides on provide more friction than does the usual mouse trackball. In addition, depending on where you press them, the buttons are slightly harder to press than those on the Logitech and Microsoft mice. Having said all that, however, we should state that using the mouse is in no way fatiguing. We're really nit-picking.

As for software, the PC Mouse comes with a menu-generator and pre-built menus for a number of popular applications (Lotus 1-2-3, WordStar, etc.). In addition, it comes with PC Paint, a draw/paint program.

The documentation is logically organized and well written. It includes a good troubleshooting section that helped us pin-point and resolve an installation problem.

Numonics

The Manager Mouse was originally designed by a company called Torrington, and that company was bought by a company called Numonics. Installation programs for various software packages may refer to the mouse as the Manager Mouse or by either company's name.

The mouse itself (as shown in Fig. 7) is unique in that it is cordless. The mouse communicates with a receiver via a pair of infrared LED's, and the receiver delivers signals to your PC via its serial port. A small wall-mount transformer powers the receiver.

The mouse contains a built-in rechargeable battery so it can be operated in cordless mode. To charge the battery, you connect a cable between the mouse and the receiver; a full charge takes about fourteen hours. You can also operate the mouse while charging. Numonics claims that a full charge should last for three or four days of typical use, because the mouse has a built-in "sleep" mode, wherein it turns off power to itself after not being used for about 60 seconds.

The Manager Mouse comes with software that allows it to emulate the Microsoft mouse and several others. Dur-

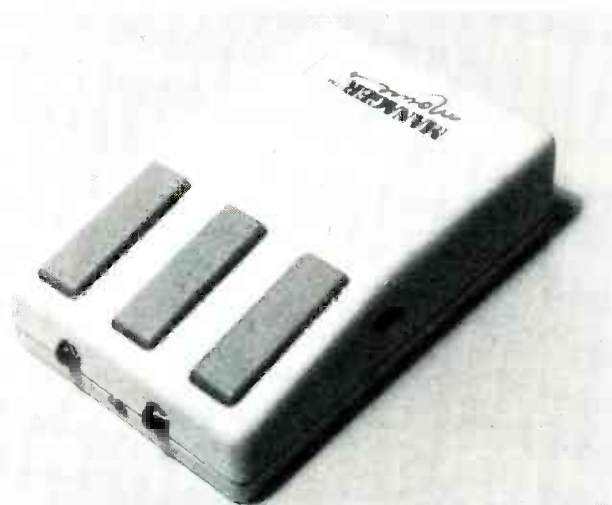

FIG. 7—The Manager Mouse

ing the course of this review, I saw several versions of the software, each of which provided progressively better compatibility with the test programs. Even the latest version, however, had problems with some software. In both AutoSketch and Dr. Halo, while emulating the Microsoft mouse the Manager Mouse's sensitivity was approximately half what it should have been, even after installing it for maximum sensitivity.

Other than that problem, using the mouse was pleasurable. It has a fairly good feel; the buttons are fairly stiff and not mushy; our test surface (a fairly slick wooden desk) provided plenty of friction for the dual plastic rollers. Use with the charging cord attached is slightly awkward, because of the cord's lack of flexibility. However, the receiver is quite sensitive and has a very wide angle of response, so you never need to worry about placement of the mouse with respect to the receiver.

No menuing software is included; in fact, the only utility software is a rather limited program called KeyFree that allows you to use the mouse for simple cursor motion in programs that don't support a mouse. In addition, KeyFree allows you to program each button to deliver a series of keystrokes, much like a keyboard macro processor. However, with only three buttons, that limits the program's capability.

Conclusions

Because none of the devices discussed here has any serious problem, choosing one is largely a matter of preference. Our personal favorite is the Microsoft mouse. Its sleek design, its excellent tactile and audible feedback, and its overall feel won us over. ▶◀

Products Discussed

- Fulcrum Trackball (\$95), Fulcrum Computer Products, 451 Allan Court, Healdsburg, CA 95448. (707) 433-0202.

CIRCLE 30 ON FREE INFORMATION CARD

- KB5153 (\$249), Keytronic, P.O. Box 14687, Spokane, WA 99214-0687. (509) 928-8000.

CIRCLE 31 ON FREE INFORMATION CARD

- Logitech Mouse (\$119), Logitech, 6505 Kaiser Drive, Fremont, CA 94555. (415) 795-8500.

CIRCLE 32 ON FREE INFORMATION CARD

- Microsoft Mouse (\$149.95), Microsoft Corporation, 16011 NE 36th Way, Box 97017, Redmond, WA 98073-9717. (206) 882-8080.

CIRCLE 33 ON FREE INFORMATION CARD

- PC Mouse (\$149), MSC Technologies, 2600 San Tomas Expressway, Santa Clara, CA 95051. (408) 988-0211.

CIRCLE 34 ON FREE INFORMATION CARD

- Manager Mouse Cordless (\$199), Numonics, 101 Commerce Drive, Montgomeryville, PA 18936. (800) 247-4517.

CIRCLE 35 ON FREE INFORMATION CARD

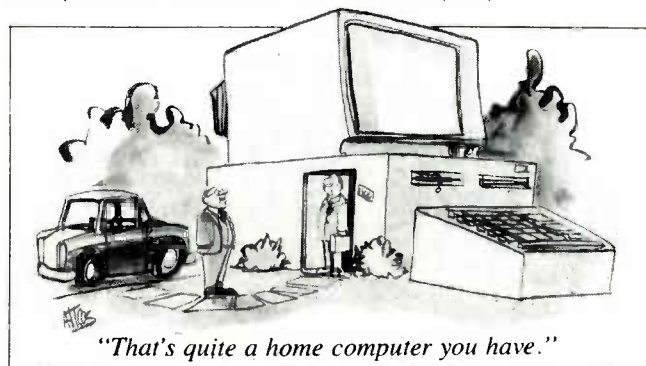

R-E Computer Admart

Rates: Ads are 2 1/4" x 2 7/8". One insertion \$825. Six insertions \$800 each. Twelve insertions \$775. each. Closing date same as regular rate card. Send order with remittance to Computer Admart, Radio Electronics Magazine, 500-B Bi-County Blvd., Farmingdale, NY 11735. Direct telephone inquiries to Arline Fishman, area code-516-293-3000. **Only 100% Computer ads are accepted for this Admart.**

ICs PROMPT DELIVERY!!!

SAME DAY SHIPPING (USUALLY)

QUANTITY ONE PRICES SHOWN FOR MARCH 15, 1988

OUTSIDE OKLAHOMA NO SALES TAX

DYNAMIC RAM		
1Mbit	1048Kx1	100 ns \$36.50
51258	* 256Kx1	80 ns 9.55
41256	256Kx1	60 ns 10.50
41256	256Kx1	80 ns 9.25
41256	256Kx1	100 ns 9.25
41256	256Kx1	120 ns 9.15
41256	256Kx1	150 ns 8.40
41264	+ 64Kx4	120 ns 9.25

EPROM		
27C1024	64Kx16	150 ns \$37.95
27C1000	128Kx8	200 ns 37.50
27C512	64Kx8	200 ns 14.95
27256	32Kx8	250 ns 6.75
27128	16Kx8	250 ns 6.50

STATIC RAM		
43256L-12	32Kx8	120 ns \$10.95
5864LP-12	8Kx8	120 ns 4.85

OPEN 6 1/2 DAYS, 7:30 AM-10 PM SHIP VIA FED-EX ON SAT.

WE EXPORT ONLY TO CANADA, GUAM, PUERTO RICO & VIRGIN ISLANDS

SAT DELIVERY INCLUDED ON FED-EX ORDERS RECEIVED BY: Th: \$8.00, Fr: \$4.10, Sa: \$11.00, Su: \$10.50/2 lb. No minimum order. Please note that prices are subject to change. Shipping & insurance extra & up to \$1 for packing materials. Orders received by 9 PM CST can usually be delivered the next morning, via Federal Express Standard Air in \$4.00, or guaranteed next day Priority One in \$19.50!

MasterCard/VISA or UPS CASH COD
Factory New, Prime Parts μ Proc
MICROPROCESSORS UNLIMITED, INC.
24,000 S. Peoria Ave.
BEGGS, OK 74421
(918) 267-4961

CIRCLE 61 ON FREE INFORMATION CARD

Why waste time?

ACCELERATE with VCACHE™

HARD DISK ACCELERATOR

- Caching eliminates repetitive disk accesses
- Use up to 15 Mb of extended/expanded or 500 Kb of standard memory

DISKETTE ACCELERATOR

SCREEN ACCELERATOR

FAST — FRIENDLY — SAFE

VCACHE

GOLDEN BOW SYSTEMS

\$49.95

Add \$3 for shipping/handling
California residents add 6% sales tax



2870 Fifth Avenue
Suite 201
San Diego, CA 92103
800/284-3269

CIRCLE 199 ON FREE INFORMATION CARD

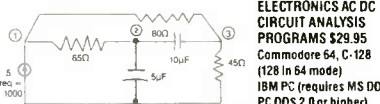

ELECTRONICS AC DC
CIRCUIT ANALYSIS
PROGRAMS \$29.95
Commodore 64, C-128
(128 in 64 mode)
IBM PC (requires MS DOS
PC DOS 2.0 or higher)

... you type computer displays ...
I 0 1 5 current source	#1 RV MG = 27.265 A = -19.47
R 1 2 65 resistor from 1 to 2	#2 RV MG = 11.163 A = -55.18
C 0 2 5E 6 capacitor from 0 to 2	#3 RV MG = 13.124 A = 43.35
C 2 3 10E -6	
R 1 3 80	ect.
R 0 3 45	
FQ 1000 set frequency	
SV solve	

Program calculates and displays general numerical solution to up to 40 node electronic circuits of resistors, capacitors, inductors, voltage or current sources, or 4 types of controlled sources, VCCS, CCCS, VCVS or CCVS. Computer displays node voltages, branch voltages branch powers and power factors (AC). Menu commands make it possible to change parameters and recalculate the solution. Programs also allow log or linear stepping of frequency or branch parameters with solution graphically displayed. Programs are menu controlled, user friendly and very easy to use.

Computer Heroes
P.O. Box 79 S
Farmington, CT 06034

ORDERS ONLY
1-800-622-4070

CIRCLE 198 ON FREE INFORMATION CARD

COMPUTER

ASSEMBLY

MANUALS



Eliminate
Guesswork!
Build with
Confidence!

BIG BLUE SEED for IBM™ BUILDERS!

Parts list, placement diagrams, instructions, mods, for assembling over 90 IBM-compatible bare cards. Latest version with guides for 640K, Turbo, AT & Baby AT MthBds. \$17.95

APPLE™ BUILDERS NEED APPLE SEED!

Instructions for assembling over 90 Apple-compatible bare cards including II+ & IIe MthBds. For ALL Apple enthusiasts and hobbyists \$14.95

SAVE 10% - ORDER TWO OR MORE MANUALS OVER 40 BARE IBM & APPLE CARDS IN STOCK (MthBds • Disk • Video • Burner • MultiFn • I/O • Modem • Proto • etc)

Check/Money-order, VISA/MasterCard to:

NuScope Associates*, Dept RE

In U.S.A.

In CANADA

P.O. Box 790

P.O. Box 742, Stn B

Lewiston, NY 14092

Willowdale, Ont. M2K 2R1

*A Division of Kosmic MicroTech Inc.

CIRCLE 72 ON FREE INFORMATION CARD

LOW COST MOTION CONTROL, INPUT, OUTPUT DATA ACQUISITION, RELAYS, A/D, Etc.

Analog Input Card 8 channel, 8 bit, 0-5 V	AD-142: \$129
Input card 8 channel on/off with opto isolators	IN-141: \$59
Relay card 8 relays, 3 Amp contacts	RE-140: \$129
24 Line TTL I/O General purpose programmable I/O (8255)	DG-148: \$65
Touch Tone Decoder for keypad or phone interface	PH-145: \$79
12 bit Analog Input Card 1 channel, 1mV resolution	AN-146: \$139
Stepper Motor/Lamp driver 8 outputs, 350mA ea.	ST-143: \$79
Clock/Calendar with alarm	CL-144: \$89
Quad Smart Stepper Controller. World's Best	SC-149: \$299

On board Z-80 controls 4 stepper motors simultaneously, 100 HZ-Level commands.

Adapters make any combination of cards work with: IBM

PC, XT, AT & compatibles; Apple II, IIe; Tandy Models

100, 102, 200, 1, 111, 4, 4P, 4D CoCo 1-3; Commodore 64, 128.

Please call (203) 656-1806 for Catalog



ALPHA Products

242-R West Avenue, Darien CT 06820

CIRCLE 200 ON FREE INFORMATION CARD

AN INTRODUCTION TO BASIC PROGRAMMING TECHNIQUES



BP86—This book is based on the author's own experience in learning BASIC and also in helping others, mostly beginners to programming, to understand the language. Included is a program library of programs that the author has actually written and run. Order your copy today. Send \$5.00 plus \$1.00 for shipping in the U.S. to Electronic Technology Today Inc., P.O. Box 240, Massapequa Park, NY 11762-0240.

GETTING THE MOST FROM YOUR PRINTER

Getting The Most From Your Printer



BP181—It is probable that 80% of dot-matrix printer users only ever use 20% of the features offered by their printers. This book will help you unlock the special features and capabilities that you probably don't even know exist. To order your copy send \$6.95 plus \$1.50 for shipping in the U.S. to Electronic Technology Today Inc., P.O. Box 240, Massapequa Park, NY 11762-0240.

BUILD THE PT-68K

Basic DRAM theory
is our topic this month.

PETER A. STARK
STARK SOFTWARE SYSTEMS CORPORATION



Copyright (C) 1988 by Peter A. Stark

Now that the PT-68K can run simple programs, it's time to add the circuitry that makes it into a full-blown system. This month we start with dynamic RAM (DRAM), one of the more complex sections of any computer. To understand how it works, let's look first at how DRAM differs from regular (static) RAM.

Computer memory organization

To begin, let's examine a simple memory IC, shown in Fig. 1. The heart of the IC is the *memory array*, which contains the actual *memory cells* in which data is stored.

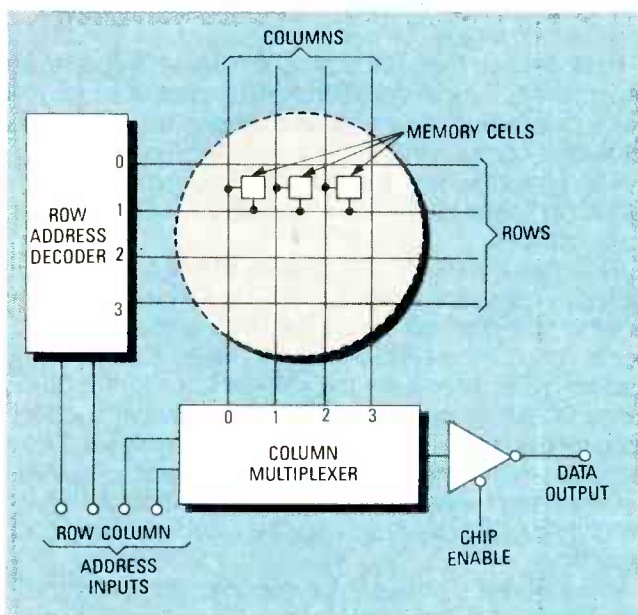

FIG. 1—BASIC ARRAY-STRUCTURE OF A MEMORY IC. In spite of differences in cell structure, both DRAM's and SRAM's use this technique.

The array shown consists of four horizontal rows and four vertical columns. A real memory chip, on the other hand, may contain hundreds of rows and columns.

At the intersection of each row and column is a cell. Since we have four rows and four columns, the array shown has room for exactly sixteen (4×4) cells, although for simplicity the figure only shows a few cells. Note that the row and column wires do not actually connect to each other. Instead, there is a cell at each intersection, and that cell has one connection to the row wire and another connection to the column wire.

To accommodate 16 cells, we could have used one row and sixteen columns, or two rows and eight columns, etc., but in practice memory arrays generally have the same number of rows and columns because that simplifies the required support circuitry. In other words, memory arrays generally tend to look like a square rather than a rectangle. Furthermore, the number of rows and columns is usually a power of 2. For example, a 16K memory chip has 128 rows and 128 columns, for a total of $128 \times 128 = 16,384$ cells. The next larger chip has 256 rows and 256 columns, for a total of $256 \times 256 = 65,536$ cells. Occasionally you see IC's with memory contents that are not an even power of two, but they're built by piggybacking two IC's or some other means. Regardless, the chip inside the IC usually has a number of cells that is an even power of two.

Each cell in the array stores one bit, so the circuit of Fig. 1 can store 16 bits. That circuit has 16 locations, each of which stores one bit, so it would be called a 16×1 memory, where the first number gives the number of locations, and the second gives the number of bits in each location. Small memory IC's often have more than one bit per location, whereas large memory IC's almost always have just one bit in each location, but many thousands of locations.

JUNE 1988

Each of the locations in the memory (that is, each cell) has an *address*; each time we read from or write to a cell, we must specify the address of the cell we want by giving the IC a binary address on its address input lines. The circuit has sixteen cells, so it requires a four-bit address to specify the cell we want. The general rule is that n address bits are needed to specify 2^n addresses, so four address bits specify 2^4 or 16 locations in our simple circuit.

The four-bit address is split into two parts: a two-bit row address and a two-bit column address. Since there are four rows, we need two bits to choose one of them (again, because 2^2 is 4); since there are four columns, we need two bits to choose a column. Keeping in mind that a memory IC has a square array (the same number of rows and columns), that means that it will need the same number of row-address bits as column-address bits. Which means that the *total* number of address bits is an even number. For example, a 16K \times 1 IC with 128 rows and 128 columns has 7 row address bits and 7 column address bits (because $2^7 = 128$), for a total of 14 address bits (and $2^{14} = 16,384$). Similarly, a 64K \times 1 IC has 256 rows and columns, eight row and column address bits ($2^8 = 256$), and a total of 16 address bits ($2^{16} = 65,536 = 64K$).

Suppose that we want to read the bit in the memory cell at the junction of row address 1 and column address 0. To do so, we send binary address 0100 (4 decimal) to the address inputs. The left two bits, 01, become the row address, and the right two bits, 00, become the column address. The row address is sent to the *row address decoder*, which has two inputs (for the row address) and four outputs (labeled 0, 1, 2, and 3) which correspond to rows 0, 1, 2, and 3. (By the way, a decoder normally has a number of outputs, only one of which is active at a time—the one specified by the binary input. In this case, the binary input (the row address) is 01, so the decoder turns on its 1 output and turns off the 0, 2, and 3 outputs.)

Of the sixteen cells in the array, the 12 cells in rows 0, 2, and 3 receive no signal from the decoder, so they do nothing. But the four cells in row 1 all receive a signal from the 1 decoder output, so they all get enabled. Each of those four cells sends its bit down a column wire to the *column multiplexer*. In other words, even though we want the contents of only one cell, all four send their contents down to the multiplexer.

The multiplexer's job (which is opposite that of the decoder) is to select the desired bit and send it to the

DRAM Price Increase

Due to the escalating cost of DRAM IC's (which have doubled in price during the past few months), Peripheral Technology regrettably must raise the prices charged for various versions of the PT-68K kit. The price of the basic kit (which has no DRAM) remains unchanged at \$200, but the price of the full kit has been raised from \$470 to \$530. Before ordering, contact the company for current prices at 1480 Terrell Mill Road, No. 870, Marietta, GA 30067, (404) 984-0742.

output buffer. The multiplexer acts like an SP4T switch (a single-pole switch with four positions) that selects one of the four inputs and sends it out the output. The input it selects depends on the binary column address. In our case, the column address is 00, so the multiplexer selects the signal entering input 0, and sends it to the three-state output buffer. If the chip-enable input is on (i.e., low, because the buffer has an active-low enable input, as shown by the bubble), then that bit goes out the data output.

As mentioned earlier, the circuit of Fig. 1 is simplified. In an actual memory IC, the chip-enable signal might also go to the decoder or to the multiplexer to prevent either from working (and drawing power) unless the chip was selected. In addition, there would be circuitry to write into cells (along with a $\bar{R}\bar{W}$ input), the array would be much larger, and there would be more components that we haven't discussed yet.

The next question is this: What is in a cell? The answer depends on the type of memory IC we are discussing. In a ROM or PROM (which, of course, is a programmable ROM), the cell might consist of just a diode, or a diode in series with a fuse. Such a cell can store either a 0 or a 1 bit, depending on whether the diode is connected or not (or on whether the fuse is blown). In an EPROM (which is an erasable programmable ROM), the cell consists essentially of a FET that is biased on or off by a charge stored in an insulating region.

There are two main kinds of cells in RAM IC's. In a static RAM (SRAM), the cell consists of a flip-flop that stores a 0 or a 1, depending on whether it is set or reset, plus some additional components that connect the flip-flop to the row and column wires. Since the flip-flop involves several transistors (often six or more per cell), the SRAM cell is quite complex.

By contrast, a DRAM cell consists of just one MOSFET and a tiny capacitor, which stores a 1 or a 0 depending on whether it is charged or not. Since the DRAM cell is so much simpler than a SRAM cell, DRAM IC's generally contain many more cells than SRAM IC's. On the other hand, DRAM memories require more external support circuitry than SRAM, and are somewhat slower. For those reasons, smaller memories are usually made of SRAM, whereas larger memories are generally made of DRAM, except when absolute top speed is a necessity and cost is no object.

In the PT-68K computer, for example, there is a small amount of SRAM (consisting of two IC's) which allows us to get the system up and running quickly. But the one megabyte of main memory is strictly dynamic to keep cost down.

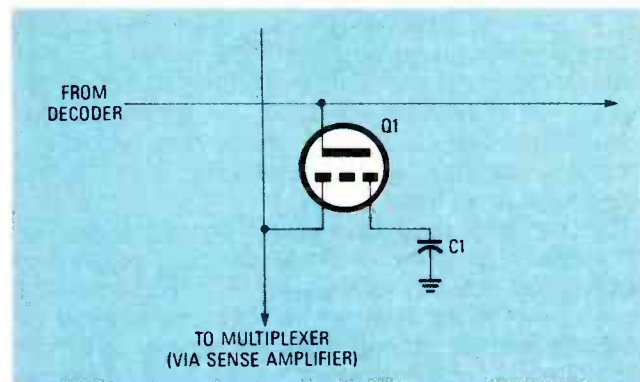

FIG. 2—BASIC DRAM CELL. The row-address decoder enables the MOSFET, which allows the charge (if any) stored on the capacitor to be presented to the column multiplexer.

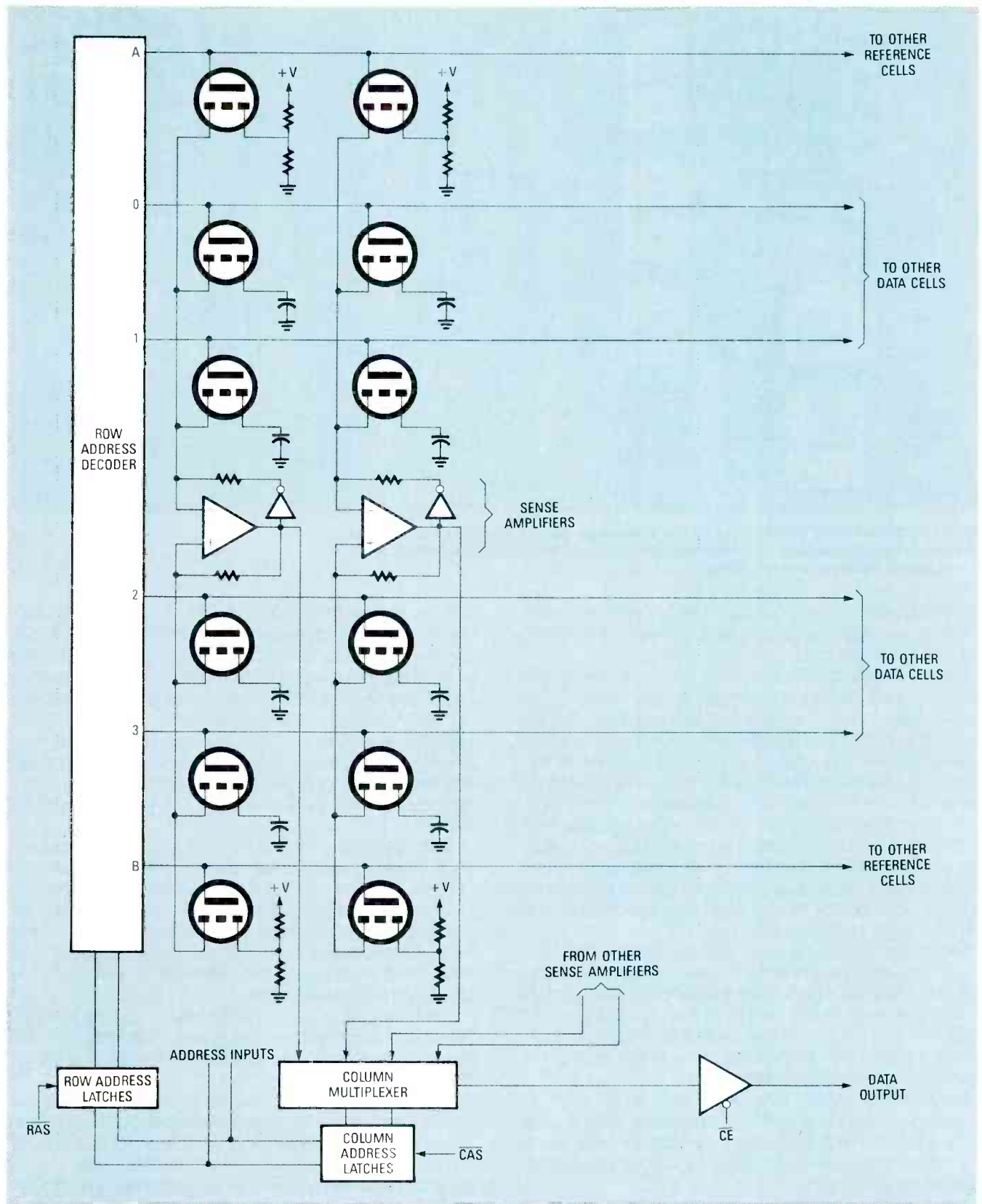

FIG. 3—REAL-WORLD DRAM. An actual IC has sense amplifiers and reference cells that serve to refresh all cells in the row currently being accessed.

Dynamic memory

Figure 2 shows a typical DRAM cell, consisting of a storage capacitor (which holds the bit of data) in series with a MOSFET. In normal operation, the decoder output is off, so the MOSFET is biased off. That isolates the storage

capacitor from the rest of the circuit, so it can retain its charge. But when the row holding the cell is selected by the decoder, the MOSFET is biased on, and the capacitor is connected to the column wire through the transistor. Now the cell can be read from, because the capacitor's

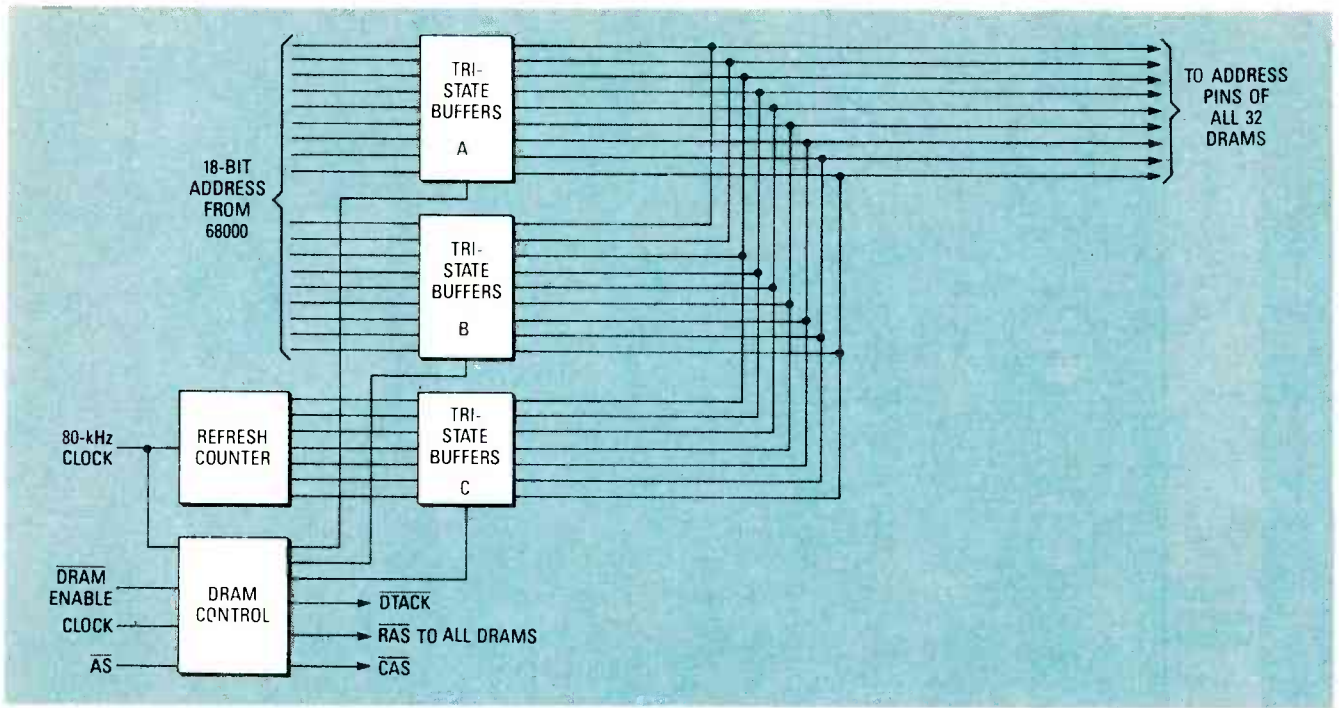

FIG. 4—PT-68K's DRAM CONTROLLER. The three-state buffers multiplex the address lines and the refresh-counter lines onto the address bus of the DRAM IC's. Details of the control circuit will be shown next time.

voltage appears on the column wire, or written to, by sending a signal up the column wire, through the MOSFET, and into the capacitor.

With no additional circuitry, there would be two major problems. First, since the capacitor is very small, it discharges very quickly. In fact, just reading the cell (by turning the MOSFET on) loads the capacitor so much that it discharges almost instantaneously. But even when the MOSFET is biased off, the capacitor typically will hold its charge for only a few seconds, and under some conditions, only a few milliseconds. Moreover, whenever a row wire is turned on by the decoder to select a cell in that row, *all of the MOSFET's in that row are turned on!* In other words, reading just one cell causes all cells in that row to be selected, with the result that all the capacitors in that row discharge immediately.

Therefore, something must prevent those cells from losing their data, and in fact the DRAM system has additional circuitry that will perform that function. That circuitry will (1) rewrite all the data back into all cells in a row whenever any cell in that row is read or written, and (2) rewrite the data into all the cells of the entire memory at intervals of a few milliseconds.

The first job—which is rewriting cells when a row is accessed—is handled internally by each DRAM IC; the second job—which is rewriting all memory cells every few milliseconds—is called *refresh* and is handled by an external *refresh circuit*.

Figure 3 shows the circuitry a typical DRAM IC uses to rewrite data into the cell capacitors whenever a row is selected. Although DRAM's typically contain thousands of cells, for simplicity and clarity the diagram in Fig. 3 shows only a small 16×1 IC with an array of four rows and four columns. And only the left two columns of that device are actually shown.

That circuit has several components we haven't seen

before. Although the 16×1 DRAM circuit needs four address bits, the diagram shows only two address bits, and they're connected to both the row-address decoder and the column multiplexer through two sets of flip-flops called the *row address latches* and the *column address latches*. Actually, the four-bit address is sent to the IC two bits at a time. The first two bits are stored in the row-address latches by a pulse on \overline{RAS} (row-address strobe), and then the second two bits are stored in the column-address latches by a pulse on \overline{CAS} (column-address strobe).

That technique is used to save pins. For example, a 256K DRAM would normally need eighteen address lines ($2^{18} = 262,144 = 256K$) to address all locations. However, by splitting the address into two parts, the eighteen bits may be input through nine address pins and two address-strobe pins. That allows eleven pins to do the work of eighteen, so the DRAM can be packaged in a smaller, less expensive case.

There are, of course, disadvantages to that process. Those disadvantages are that external circuits must split the address into two parts, and the process takes longer than it would otherwise.

As before, the two-bit row address is again sent to the row-address decoder, which outputs a pulse on one of the four row lines labeled 0–3, depending on the value of the row address. Note, however, that the array is now divided by a row of *sense amplifiers* running across the middle of the diagram. The sense amplifiers are essentially op-amps or comparators, and have inverting (–) and non-inverting (+) inputs.

In addition, there are two more rows, labeled A and B, each of which contains a row of *reference cells*, which are similar to regular cells, except that they are connected to a voltage divider instead of a capacitor. Therefore they always output a constant voltage, whose value is halfway

between logical 0 and 1. In addition, the decoder is modified so that whenever it selects a data row (0–3), it also selects a reference row, making sure that the reference row is on the opposite side of the sense amplifiers.

For example, again let's assume we want to read the contents of location four (0100 binary). The row address (01) entering the decoder selects row 1; at the same time, the decoder enables the row of reference cells connected to output B. Note that the reference row is opposite the sense amplifiers: row B is selected with rows 0 and 1, and row A is selected with rows 2 and 3.

When row 1 is selected, all MOSFET's connected to that row are turned on, and all four capacitors on that row send their voltage to the inverting input of a sense amplifier. At the same time, the non-inverting input of each sense amplifier gets a reference voltage from a reference cell at the bottom. Since the reference is a voltage between (logical) 0 and 1, the sense amplifier can compare the capacitor voltage against the reference and decide whether the capacitor holds a 0 or a 1.

All of that must happen very quickly, because the capacitor discharges almost immediately. By then, however, the bit stored in the capacitor has already arrived at the output of the sense amplifier, which sends it down to the multiplexer and the output.

But each of the sense amplifiers has a positive-feedback circuit connected from the output back to both inputs. The actual circuit is somewhat different and more complicated than what is shown in Fig. 3, but the main idea is this: As soon as the bit arrives at the output of the sense amplifier, it is immediately sent back to the inputs through the two resistors. The signal fed through the inverting buffer to the inverting input of the sense amplifier returns in the opposite polarity, but larger. That signal then recharges (refreshes) the capacitor. If the original capacitor voltage was lower than the reference voltage, the feedback circuit pushes it back down toward ground; if it was higher than the reference, the circuit pushes it up toward the positive supply voltage.

Even though we only wanted to read the bit stored in the capacitor in row 1, every capacitor in that row was read out and refreshed by its own sense amplifier. And that's an important concept: *reading out any cell automatically refreshes all the cells located in the same row.*

When such a DRAM IC is connected to a microprocessor, each time the processor reads (or writes—Fig. 3 does not show any of the circuitry for writing into a cell, but that is accomplished by feeding bits back through the multiplexer), it refreshes an entire row of each DRAM IC. If the computer were to use data from every row, then the entire IC would be refreshed automatically and we wouldn't have to do anything. In general, though, we cannot trust that to happen, because the computer could easily get stuck in a loop in which it accessed only one or two rows, with the result that the remainder of memory would be lost. Therefore we must add external refresh circuitry to make sure that every row of each DRAM IC is properly refreshed.

DRAM refreshing

Most current DRAM's must be completely refreshed once every two milliseconds, so the refresh circuits must ensure that every row of memory is accessed at least once every two milliseconds. To minimize the effort

required, IC makers build larger DRAM IC's differently than smaller ones. In smaller DRAM's (up to $16K \times 1$), the array is essentially square as we have discussed, and has 128 or fewer rows. In larger memories, the array wiring is split to make several smaller arrays out of the one large array, with each smaller array having only 128 rows and all arrays being refreshed at the same time. As a result, instead of a $256K \times 1$ DRAM having 512 rows and therefore needing 512 reads for refreshing, it only needs 128 reads. That makes refreshing faster.

There are two basic ways of refreshing DRAM. The cheapest, requiring little hardware, is to build an oscillator that interrupts the CPU once every two milliseconds, forces it to stop the current program, and then execute an interrupt routine that does a read from every row and then returns to the main program. That software approach has the disadvantage that it wastes a significant portion of the computer's time and slows down every program. For instance, if a read of one row (counting the time to fetch and perform the read instruction) requires four microseconds (which is not unusual for an average 8-bit microprocessor), then 512 microseconds (plus interrupt processing time) would be taken up out of every 2 milliseconds for refresh. In other words, more than a quarter of the processor's time would be used up just on refresh.

The second approach is to build a counter that counts from 0 to 127, and sends its output as a refresh address to the memory. The counter must go through the complete cycle at least once every 2 milliseconds, and every one of those counts must be sent to the memory. The trick is to do it without slowing down the processor or affecting any programs. To accomplish that goal, designers use several techniques, some of which are better than others.

One approach is to halt the processor periodically and send 128 counts to the DRAM's instead, either individually or as a burst. If the computer has a direct memory-access (DMA) circuit, then that is easily handled by the same circuitry. IBM PC's and clones use that approach; unfortunately, it slows down programs, so it's not the best possible approach.

The best—and the most expensive—approach is to split the memory into two halves. Whenever the CPU accesses one half, refresh the other half. For example, in an eight-bit computer, all the even locations could be in one half of the memory, and all the odd locations in the other half. Since most of a computer's time is spent accessing consecutive locations, it mostly alternates from one half to the other, so each half of memory is unused roughly 50% of the time. That leaves plenty of time to do memory refresh without slowing down the processor.

A middle-of-the-road approach is to detect clock cycles during which the CPU is doing internal operations instead of using the memory, and then to squeeze refresh accesses into those unused slots. With a processor that uses many cycles for internal operations, it's easy to sneak in refreshes without slowing down the processor at all. However, that approach doesn't work as well with processors that use the address bus fairly heavily. In that case, the refresh circuits may be able to sandwich many—or even most—of their memory accesses between CPU memory accesses, but there may still be occasional conflicts when both need to access memory at the same time. In that case the refresh circuit must get priority to

avoid losing data in memory, so there must be a fairly complex circuit that arbitrates between CPU and refresh accesses to memory. That is the approach used in the PT-68K computer, and it slows down CPU operation an average of one or two percent.

Back to the PT-68K

A block diagram of the DRAM circuit is shown in Fig. 4. Overall refresh timing is handled by the DRAM control circuits, which receive the \overline{DRAM} enable signal from the address decoder, the \overline{AS} address strobe, and a clock, and which generate the \overline{RAS} , \overline{CAS} , and \overline{TACK} signals, as well as three enable signals which control three sets of three-state buffers.

Those buffers are separately enabled by the DRAM control circuits, and only one set of buffers is enabled at any one time. That way, three different inputs can be combined onto one set of pins. When the CPU is accessing memory, the buffers work in this order:

1. The 68000 outputs an address, the address decoder recognizes a DRAM address and sends the \overline{DRAM} enable signal to the DRAM control circuits.

2. The control circuits enable three-state buffer A (and disables B and C), which sends nine bits of the address to the DRAM IC's. Then \overline{RAS} is pulsed, latching the appropriate addresses in the row-address buffers within each DRAM.

3. The control circuits then enable buffer B (and disables A and C), which in turn sends the other nine bits of the address to the DRAM. Then \overline{CAS} is pulsed, latching the appropriate addresses in the column-address buffers within the DRAM.

The \overline{RAS} signal goes to each DRAM IC so that all IC's, even those not being used, receive a row address. But \overline{CAS} goes back to the address decoder (shown in Fig. 3 in the January issue), which steers \overline{CAS} to the appropriate group of IC's.

The PT-68K uses 32 256K \times 1 DRAM IC's to provide a total of one megabyte of RAM. Those IC's are organized in four banks of 256K bytes each as follows:

IC38 through IC45 hold all the odd bytes for the first 512K.

IC53 through IC60 hold all the even bytes for the first 512K.

IC67 through IC74 hold all the odd bytes for the second 512K.

IC80 through IC87 hold all the even bytes for the second 512K.

When a particular byte (or 16-bit word, in the case of a two-byte transfer) is accessed, only one or two banks need be enabled. Therefore, the address decoder does the final selection, based on the state of A19, \overline{UDS} , and \overline{LDS} ; and it sends \overline{CAS} only to those banks being accessed. The DRAM IC's use \overline{CAS} as their main chip enable, and only those IC's getting \overline{CAS} do an actual read or write.

Refresh is initiated by the 80-kHz clock input to the refresh counter and the DRAM control circuits. Once every 12.5 microseconds a clock pulse arrives, increments the refresh counter to a new row address, and sends a refresh request to the DRAM control circuits. The control circuits then wait until the 68000 stops using the memory and then begin the refresh sequence by enabling three-state buffer C (meanwhile disabling A and B), which sends the refresh address to the DRAM chips, followed by pulsing \overline{RAS} . Since \overline{RAS} as well as the address lines go to all 32 DRAMs, all the DRAMs are refreshed at the same time.

The complete refresh cycle for all 128 rows takes 1.6 milliseconds (12.5 microseconds between clock pulses times 128 rows), which is somewhat less than the 2 milliseconds specified for most DRAM's. (There is nothing at all wrong with refreshing the DRAMs more often.)

Next time

Now that we understand the concepts behind DRAM refreshing and operation, we can continue with the complete DRAM memory circuit of the PT-68K. But we are running out of room this month, so we'll have to wait for that until next time. See you then. \blacklozenge

EDITOR'S WORKBENCH

continued from page 86

provided for AutoCAD and Windows that allow you to run those programs at a resolution of 800 \times 600. The results are simply stunning. In fact, the Designer EGA has a maximum resolution of 1024 \times 768, but the Multisync used for testing has a maximum resolution of 800 \times 600. An additional driver (untested) is supplied that allows Lotus 1-2-3 to run with 132 columns and 25, 28, or 44 lines.

Tseng Labs (whose EVA/480 was reviewed in the May 1987 issue) designed the VLSI IC that is the core of the board (and those sold by several other manufacturers as well). Several utility programs are provided with the Designer VGA that strongly resemble similar programs provided with the EVA/480: a font editor (for creating your own on-screen fonts), a program for setting text mode in

DOS (40 \times 25, 80 \times 25, 80 \times 60, 132 \times 25, 132 \times 28, and 132 \times 44), and a program that allows you to do hardware zooming in AutoCAD and other programs. WordStar 4.0 (which can be configured for various screen sizes) worked in the large text formats (80 \times 60 and 132 \times 44) just fine.

Compatibility is an issue with VGA adapters. Attaining BIOS-level compatibility is relatively simple, but hardware-level compatibility is much more difficult. In fact, IBM itself has stated that its own old-bus VGA adapter may not be 100% compatible with the built-in PS/2 VGA adapter. As stated, we detected no problems whatsoever with the Designer VGA. However, the board did fail a test program distributed by Paradise Systems (whose own VGA card has been delayed several times attempting to attain full hardware-level compatibility). It may turn out that the tests in question will not be relevant to real-world software, but at this time no one knows for sure. \blacklozenge

NOTICES

Mario Maniscalco's reader challenge that appeared in his article on data encryption in the April 1988 issue has been extended until April 30, 1989. After that date, the author will send the encryption key and the decrypted message to any reader who sends an SASE to the following address: P.O. Box 11235, Cleveland, OH 44111. The IBM format disk containing source and executable code for the encryption program, as well as files containing the encrypted message, a proof of the algorithm's efficacy that had to be omitted from the published article because of space, and other information is still available at that address for \$10. \blacklozenge

PRODUCT REVIEWED

• Designer VGA (\$445), Orchid Technology, 45365 Northport Loop West, Fremont, CA 94538. (415) 490-8526

MARKET CENTER

FOR SALE

TV tunable notch filters, free brochure. **D.K. VIDEO**, Box 63/6025, Margate, FL 33063 1-(305) 752-9202.

TWO-Way-Radio, Atari, Uniden service. General Radiotelephone licensed technician. Catalog-**RAYS**, 2025 Moline, Ft. Worth, TX 76117 (817) 831-7717.

CLASSIFIED AD ORDER FORM

To run your own classified ad, put one word on each of the lines below and send this form along with your check to:

Radio-Electronics Classified Ads, 500-B Bi-County Boulevard, Farmingdale, NY 11735

PLEASE INDICATE in which category of classified advertising you wish your ad to appear. For special headings, there is a surcharge of **\$23.00**.

() Plans/Kits () Business Opportunities () For Sale
() Education/Instruction () Wanted () Satellite Television
()

Special Category: \$23.00

PLEASE PRINT EACH WORD SEPARATELY, IN BLOCK LETTERS.

(No refunds or credits for typesetting errors can be made unless you clearly print or type your copy.) Rates indicated are for standard style classified ads only. See below for additional charges for special ads. **Minimum: 15 words.**

1	2	3	4	5
6	7	8	9	10
11	12	13	14	15 (\$42.75)
16 (\$45.60)	17 (\$48.45)	18 (\$51.30)	19 (\$54.15)	20 (\$57.00)
21 (\$59.85)	22 (\$62.70)	23 (\$65.55)	24 (\$68.40)	25 (\$71.25)
26 (\$74.10)	27 (\$76.95)	28 (\$79.80)	29 (\$82.65)	30 (\$85.50)
31 (\$88.35)	32 (\$91.10)	33 (\$94.05)	34 (\$96.90)	35 (\$99.75)

We accept MasterCard and Visa for payment of orders. If you wish to use your credit card to pay for your ad fill in the following additional information (Sorry, no telephone orders can be accepted.):

Card Number

Expiration Date

Please Print Name

Signature

IF YOU USE A BOX NUMBER YOU MUST INCLUDE YOUR PERMANENT ADDRESS AND PHONE NUMBER FOR OUR FILES. ADS SUBMITTED WITHOUT THIS INFORMATION WILL NOT BE ACCEPTED.

CLASSIFIED COMMERCIAL RATE: (for firms or individuals offering commercial products or services) \$2.85 per word prepaid (no charge for zip code)...**MINIMUM 15 WORDS.** 5% discount for same ad in 6 issues; 10% discount for same ad in 12 issues within one year; if prepaid. **NON-COMMERCIAL RATE:** (for individuals who want to buy or sell a personal item) \$2.30 per word, prepaid...no minimum. **ONLY FIRST WORD AND NAME** set in bold caps at no extra charge. Additional bold face (not available as all caps) 50¢ per word additional. Entire ad in boldface, \$3.40 per word. **TINT SCREEN BEHIND ENTIRE AD: \$3.55 per word. TINT SCREEN BEHIND ENTIRE AD PLUS ALL BOLD FACE AD: \$4.15 per word. EXPANDED TYPE AD: \$4.30 per word prepaid.** Entire ad in boldface, \$5.15 per word. **TINT SCREEN BEHIND ENTIRE EXPANDED TYPE AD: \$5.40 per word. TINT SCREEN BEHIND ENTIRE EXPANDED TYPE AD PLUS ALL BOLD FACE AD: \$6.25 per word. DISPLAY ADS:** 1" x 2 1/4"—\$320.00; 2" x 2 1/4"—\$640.00; 3" x 2 1/4"—\$960.00. **General Information:** Frequency rates and repayment discounts are available. **ALL COPY SUBJECT TO PUBLISHERS APPROVAL. ADVERTISEMENTS USING P.O. BOX ADDRESS WILL NOT BE ACCEPTED UNTIL ADVERTISER SUPPLIES PUBLISHER WITH PERMANENT ADDRESS AND PHONE NUMBER.** Copy to be in our hands on the 12th of the third month preceding the date of the issue. (i.e., Aug. issue copy must be received by May 12th). When normal closing date falls on Saturday, Sunday or Holiday, issue closes on preceding working day. Send for the classified brochure. Circle Number 49 on the Free Information Card.

DESCRAMBLERS. All brands. Special: Jerrold combo 400 and SB3 \$165. Complete cable descrambler kit \$39. Complete satellite descrambler kit \$45.00. Free catalog. **MJM INDUSTRY**, Box 531, Bronx, NY 10461-0531.

TUBES, new, unused. Send self-addressed, stamped envelope for list. **FALA ELECTRONICS**, Box 1376-2, Milwaukee, WI 53201.

PHOTOFAC folders, under #1400 \$3.00. Others \$5.00. Postpaid. **LOEB**, 414 Chestnut Lane, East Meadow, NY 11554.

TRANSISTORS-tubes: MRF421 \$24.00, MRF454 \$14.50, MRF455-MRF477 \$11.75, MRF492 \$16.00, SRF2072 \$12.75, SRF3800 \$17.50, 2SC2290 \$16.75, 2SC2879 \$22.00, 6LF6, 6LQ6, 6JS6, 8950, etc-call. New **Ranger AR3500** all mode 10 Meter transceiver \$319.00. Quantity discounts! Best prices on hard-to-find parts, antennas, mics, power supplies, & equipment! Catalog \$1.00 (refundable), or free with order. **RFPC**, Box 700, San Marcos, CA 92069. For information or same day shipment—call (619) 744-0728. Visa/MC/C.O.D.

LASERS, components and accessories. Free catalog. **M.J. NEAL COMPANY**, 6672 Mallard Court, Orient, OH 43146.

PICTURE flyer lists quality surplus electronics at low prices. Since 1970. Send for the last 3 issues. **STAR-TRONICS**, Box 683, McMinnville, OR 97128.

FREE CATALOG

FAMOUS "FIRESTIK" BRAND CB ANTENNAS AND ACCESSORIES. QUALITY PRODUCTS FOR THE SERIOUS CB'er. SINCE 1962
FIRESTIK ANTENNA COMPANY
2614 EAST ADAMS
PHOENIX, ARIZONA 85034

MICROWAVE antennas, multichannel 1.9-2.7 Ghz dual polarity. From only \$49.95. "Best in the west!" **GALAXY ELECTRONICS**. Call 1 (602) 939-1151.

SATELLITE & cable equipment. We have those hard-to-find units ready to go. Tired of junk that doesn't work properly? Try our 10 day satisfaction guarantee & 90 day warranty (wholesale only). **HI TECH ELECTRONICS**, PO Box 42423, Detroit, MI 48242, (313) 722-9381.

TUBES, name brands, new, 80% off list. **KIRBY**, 298 West Carmel Drive, Carmel, IN 46032.

IS it true...jeeps for \$44 through the government? Call for facts! 1-(312) 742-1142, ext. 4673.

NUTS & VOLTS P.O. Box 1111-E
MAGAZINE Placencia, CA 92670
714-632-7721

GIVE YOURSELF A BREAK — A PRICE BREAK!
NUTS & VOLTS WILL **Save YOU MONEY**
ON ELECTRONIC PARTS & EQUIPMENT
**Plus SHOW YOU WHERE TO FIND UNIQUE,
UNUSUAL AND HARD-TO-FIND ITEMS.**

SUBSCRIBE TODAY!

A National Publication For The Buying And Selling Of Electronic Equipment

Subscription Rates	3.5 INCH SQUARES
1st Class Mail - USA	One Year \$10.00
	Two Years \$18.00
	Lifetime \$50.00
1st Class Mail	
	One Year USA \$18.00
	Canada/Mexico \$20.00
Air Mail	
	Foreign 1 Yr \$30.00

GREAT buys! Surplus prices, ICs, linears, transformers, PS, stepping motors, vacuum pump, phototransistor, meters, Isase, **FERTIK'S**, 5400 Ella, Phila., PA 19120.

SALE! SCR, transistor, diode tester. Dropproof jeweled meter. \$69.00 + UPS shipping. **GALAXY**, 1834 S.E. 22nd, Portland, OR 97214.

LEADER LFC-945A signal level meter \$395.00 (312) 771-4661.

SURPLUS Zenith Z100 computer motherboards. No RAM/ROM, over 100 chips in sockets including 8088, 8085, 74LSxxx, crystals and more, \$49.95. Boards without chips \$12.95 shipping included. Visa Master. **LYNBAR INDUSTRIES**, (616) 983-3389.

AMAZING SCIENTIFIC & ELECTRONIC PRODUCTS

PLANS—Build Yourself—All Parts Available In Stock

- LC7—BURNING CUTTING CO₂ LASER \$ 20.00
- RUB4—PORTABLE LASER RAY PISTOL 20.00
- TCC1—3 SEPARATE TESLA COIL
- PLANS TO 1.5 MEV. 20.00
- IOG1—ION RAY GUN 10.00
- GRA1—GRAVITY GENERATOR 10.00
- EML1—ELECTRO MAGNET COIL GUN/LAUNCHER 6.00

KITS

- MFT3K—FM VOICE TRANSMITTER 3 MI RANGE 49.50
- VWP7—TELEPHONE TRANSMITTER 3 MI RANGE 39.50
- BTC3K—250.00 VOLT 10-14" SPARK TESLA COIL 199.50
- LHC2K—SIMULATED MULTICOLOR LASER 39.50
- BLS1K—100,000 WATT BLASTER OFFENSE DEVICE 69.50
- ITM1K—100,000 VOLT 20" AFFECTIVE RANGE INTIMIDATOR 69.50
- PSP4K—TIME VARIANT SHOCK WAVE PISTOL 59.50
- PTG1K—SPECTACULAR PLASMA TORNADO GENERATOR 149.50
- MVIK—SEE IN DARK KIT 199.50

ASSEMBLED

- PTW1K—SPECIAL EFFECT VISUAL PLASMA GENERATOR FOR GLOBES/NEON TUBING ETC \$59.50
- BTC10—50,000 VOLT—WORLD'S SMALLEST TESLA COIL 49.50
- LGU40—1MW HeNe VISIBLE RED LASER GUN 249.50
- TAT30 AUTO TELEPHONE RECORDING DEVICE 24.50
- GPV10—SEE IN TOTAL DARKNESS IR VIEWER 349.50
- LIST10—SNOOPER PHONE INFINITY TRANSMITTER 169.50
- IPG70—INVISIBLE PAIN FIELD GENERATOR—MULTI-MODE 74.50

• CATALOG CONTAINING DESCRIPTIONS OF ABOVE PLUS HUNDREDS MORE AVAILABLE FOR \$1.00 OR USE OUR PHONE FOR "ORDERS ONLY" 603-673-4730

PLEASE INCLUDE \$3.00 PH ON ALL KITS AND PRODUCTS PLANS ARE POSTAGE PAID. SEND CHECK, MO, VISA, MC IN US FUNDS.

INFORMATION UNLIMITED
P.O. BOX 716 DEPT. RE, AMHERST, NH 03031

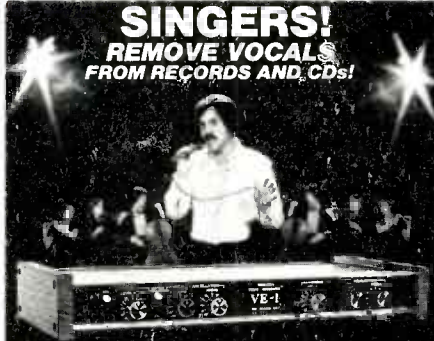

SINGERS! REMOVE VOCALS FROM RECORDS AND CDS!

SING WITH THE WORLD'S BEST BANDS!
An Unlimited supply of Backgrounds from standard stereo records! Record with your voice or perform live with the backgrounds, Used in Professional Performance, yet connects easily to a home component stereo. This unique product is manufactured and sold Exclusively by LT Sound - Not sold through dealers. Call or write for a Free Brochure and Demo Record.

LT Sound, Dept. R L-3, 7980 LT Parkway
Lithonia, GA 30058 (404) 482-4724
Manufactured and Sold Exclusively by LT Sound
24 HOUR PHONE DEMO LINE: 14041482-2485

RUN three-phase motors on single phase, free brochure. **MOTORS**, Box 63/6025, Margate, FL 33063 1-(305) 752-9202.

TUBES, "Oldest," "latest." Parts and schematics. SASE for lists. **STEINMETZ ELECTRONICS**, 7519 Maplewood Ave., R.E. Hammond, IN 46324.

SOLAR battery chargers. Homes, RVs, boats. From \$30.00. Brochure. **SUNPOWER**, Texas, Dept. 01B, P.O.B. 2788A, Freeport, TX 77544.

TESLA coils—Kirlian electrophotography—plasma bulbs... Free 1988 science plan catalog! **SCIEN-TIFIC**, Box 1054HRH, Duvall, WA 98019.

ELECTRONIC liquidators, computer kits, thousands of parts, chips, transistors, speakers, hardware, hobby kits, surplus, send \$3.50 for catalog. **BOX 27656**, Lansing, MI 48901.

C.A.T.V. Descrambling manual. 220+ full pages with schematics, \$24.95. Others available. Catalog \$2.00. **DATA DISTRIBUTORS**, P.O. Box 5612, Springfield, VA 22150. C.O.D.'s welcome (703) 425-0652.

ATTENTION laser holographic experimenters: optical computer components, instructions. \$22.95 postpaid. **STELLAR TECHNOLOGIES**, 4710 University Way N.E., #1003, Seattle, WA 98105.

TECHNICAL manuals for military surplus electronics: radios, transmitters, test sets, etc. Hundreds in stock. Send SASE with want list. **BOOKS**, 7218 Roanne Drive, Oxon Hill, MD 20745.

CB RADIO OWNERS!
We specialize in a wide variety of technical information, parts and services for CB radios. 10-Meter and FM conversion kits, repair books, plans, high-performance accessories. Over 12 years of satisfied customers! Catalog \$2.
CBC INTERNATIONAL
P.O. BOX 31500RE, PHOENIX, AZ 85046

RADAR detectors whistler all remotes spectrum 1,2 modified completely hidden your dashboard, flash brakelite. Send \$1.00 info-prices: No N.J. orders!
CARMODS ELECTRONICS, 33 Aldom Circle, West Caldwell, NJ 07006.

PROGRAMMER for single component micro computer. Learn to program, control circuits, generate waveforms. SASE details. **DELL COMMUNICATIONS**, 536 Griscom Dr., Deptford, NJ 08096.

SOFTWARE: IBM/compatible, high quality and priced under \$15. For catalog send \$2 to **GROB-MAN ENTERPRISES**, 2892 Saddle Ridge Drive, Yorktown Heights, NY 10598.

AIDS? Yes we have! Cable aids to help you. Zenith, Jerrold, Scientific Atlanta, Oak, Hamlins, much more. No Michigan sales! **HOTRONICS**, (313) 675-5834.

VCR/ TV adjustment tape VHS \$18.50 VCR maintenance/repair guide \$7.50 western **HEMISPHERE ENTERPRISES**, Box 673, Commack, NY 11725.

ATTENTION, are you looking for surplus test equipment volt meters oscilloscope, etc. **J.B. ELECTRONICS**, 9518 W. Grand, Franklin Park, IL 60131, (312) 451-1750.

LIMITED surplus electronic components send SASE for list. **JENNINGS**, Box 185, Washington Depot, CT 06794.

ROOM or telephone monitor. Range unlimited. \$88.00, catalog \$3.00. **LISTEN**, 603 Elgin, Muskogee, OK 74401. 1 (800) 633-8277.

RESTRICTED technical information: Electronic surveillance, schematics, locksmithing, covert sciences, hacking, etc. **Huge selection. Free brochures.** **MENTOR-Z**, 135-53 No. Blvd., Flushing, NY 11354.

CONVERTER sales and repairs on all types S.A., Jerrold, Panasonic, Pioneer. **REDCOAT ELECTRONICS**, (718) 459-5088.

Oak M35B combo \$90.00; **VSM35B** \$100.00; **Eagle** channel 3 double notch filters \$24.00; **Jerrold DRZ-3DIC** rebuilt combos, new cases, new remotes, \$175.00; **Sylvania 4040** combos, wireless remotes, \$135.00; **Eagle EVPDC** wireless remote converter, descrambler, parental, favorite channel, fine tune, \$175.00; all prices COD delivered to you! **PONDEROSA**, (719) 661-1659.

VIDEO sender no wires watch TV in any room even on patio \$69.95 plus \$5.95 shipping, mo. ck. C.O.D. to **VIDEO SENDER**, 481 West Willow #103R, Long Beach, CA 90806.

HAVE various selections of electronic parts, and/or equipment ready made or needs assembly for sale, Call (201) 752-0181 for info.

FREE remote control converter with purchase of SB3, N12, VN12, SA3, etc. While quantities last. **PONDEROSA**, (719) 661-1659.

FREE power supply, connectors (\$8.95 value) with assortment #103 (February 1984 article) contains **PCB, Toko coils, transistors, IC's, diodes**. \$25.00. Five/\$112.50. **Assortment #104 contains all other parts**. \$10. Shipping \$2.00. **JIM RHODES, INC.**, PO Box 3421, Bristol, TN 37625.

20 to 40% off retail computer parts! Free catalog. Dealers wanted. **NETCOM**, Box 12056-RE, Omaha, NE 68152.

CABLE descrambler liquidation. Major makes and models available. Industry pricing! (Example: Hamlin Combo's, \$44 each... minimum 10 orders). **Dealers only!** Call **WEST COAST ELECTRONICS**, (818) 989-0890.

COMMODORE Amiga chips or repairs. C-64 repair \$39.95 includes parts/labor. We sell low cost Commodore/Amiga chips—6526/6510—\$8.95, 82S100/PLA—\$11.95 and many others. Heavy duty C64 P.S. \$27.95 + pp. "Commodore Diagnostician," a complete chart for diagnosing faulty IC's \$6.95 + UPS. Send for complete catalog. **VISA/MC. KASARA INC.**, 31 Murray Hill Drive, Spring Valley, NY 10977, 1-(800) 248-2983 (Nationwide) or (914) 356-3131.

HACKER'S handbook, \$12.95. **Computer under-ground**, \$14.95, send \$1 postage. **CABLETRONICS**, Box 30502R, Bethesda, MD 20814.

CLOSEOUTS: SB3's \$59.95 telephones real thing "Bell" dial desk/wall \$29.95. Garfield wall T/P \$36.95. 25' handset cords \$1.49. **Repairs** cordless phones \$31.50 + parts, scanners \$36.00 + parts, 2-way FM radios \$45.00 + parts. COD's, Visa/MC, warranty, \$1-brochure/order form. **RADD**, 104 S. Broadway, Peru, IN 46970.

PLANS AND KITS

TELEPHONE extension in-use indicator. Ends interrupted calls and eavesdropping. Complete kits \$9.95. **D.A. AIREY**, 54 Nelson Street, Winchester, MA 01890.

CRYSTAL radio sets, plans, parts, kits, catalog \$1.00. **MIDCO**, 660 North Dixie Highway, Hollywood, FL 33020.

CONSOLIDATED ELECTRONICS

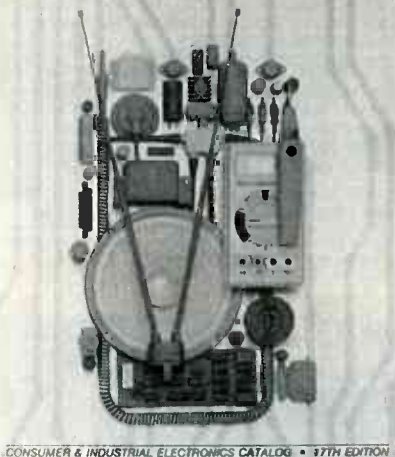

CONSUMER & INDUSTRIAL ELECTRONICS CATALOG • 17TH EDITION

THE ULTIMATE ELECTRONICS CATALOG.

Order your 260 page catalogue packed with over 10,000 money saving electronic parts and equipment. Send \$3.00 check or money order, or call 1-800-543-3568 today and use your Mastercard or Visa.
Consolidated Electronics, Incorporated
705 Watervliet Ave., Dayton, Ohio 45420-2599

NAME _____
ADDRESS _____
CITY _____
STATE _____ ZIP _____

CIRCLE 203 ON FREE INFORMATION CARD

RADIO-ELECTRONICS

High fidelity loudspeaker kits, and components from the world's finest manufacturers. For beginners, audiophiles and service. **Free literature. A&S SPEAKERS**, 3170 23rd Street, San Francisco, CA 94110. (415) 641-4573.

VOICE disguisers! FM bugs! Telephone transmitters! Phone snoops! More! Catalog \$1.00 (Refundable): **XANDI ELECTRONICS**, Box 25647, 60B, Tempe, AZ 85282.

BUILD this five-digit panel meter and square-wave generator including an ohms, capacitance and frequency meter. Detailed instructions \$2.50. **BAGNALL ELECTRONICS**, 179 May, Fairfield, CT 06430.

THE DECODER. National monthly technical satellite/cable descrambling newsletter. News-schematics-modifications-reviews \$18.00/year. Sample \$3.00. **TELECODE**, Box 6426, Yuma, AZ 85364-08740.

STRANGE stuff. Complete items, plans, kits. Laser eavesdropping, hidden weapons, bugging and countermeasure sources, adult toys. Informational photo package \$3.00 refundable. **DIRIJO CORPORATION**, Box 212-R, Lowell, NC 28098. Information (704) 868-3408.

REMOTE CONTROL KEYCHAIN



Complete w/mini-transmitter and +5 vdc RF receiver. Fully assembled including plans to build your own auto alarm and extend the range.

Check, Visa or M/C. \$19.95. 30 days return.

VISITECT INC. (415) 872-0128
PO BOX 5442, SO. SAN FRAN., CA 94080.

CHEMICAL magic. Those hard-to-find formulas. Catalog \$1. **CFC**, Box 30007 Des Moines, IA 50310.

VIDEOPHILIP II technical manuals. 120+ pages. Volume 1—hardware, Volume 2—software. Either \$29.95 both \$49.95. Catalog—\$3.00. **MICROTRONICS**, Box 6426, Yuma, AZ 85364-0840.

MAKE your light bulbs last 10 years. Free information. **INTERNATIONAL**, 5425-E West Almeria, Phoenix, AZ 85035.

PROJECTION TV...Convert your TV to project 7 foot picture. Results comparable to \$2,500 projectors...total cost less than \$30.00. Plans and 8" lens \$24.95...Illustrated information free...**MACROCOMA-GJ**, Washington Crossing, PA 18977. Creditcard orders 24hrs (215) 736-3979.

(EP)ROM Emulator/programmers. Develop ROMs for your own microprocessor-based designs. Free information sheet. **SOLICON**, 8825 El Matador Dr., Gilroy, CA 95020.



DETAILED PLANS: \$4.95
TV-SCOPE
PENN RESEARCH,
Box 3543
Williamsport, PA 17701

FINALLY!

An interesting and worthwhile project. This **EASY-TO-BUILD** circuit lets you use any regular TV set as a simple **OSCILLOSCOPE**. Build for less than \$10. **NO MODIFICATIONS TO TV!** Single or dual trace. Send for **FREE CATALOG** of other plans and kits.

CATALOG: Hobby/broadcasting/HAM/CB: Cable TV, transmitters, amplifiers, bugging devices, computers, more! **PANAXIS**, Box 130-F6, Paradise, CA 95967

VIDEO catalog, electronic kits, remote control items much more. Write **VIDEO VIBES**, 670 Central Park Ave., Yonkers, NY 10704. (914) 476-4864.

FREE catalog 99-cents kits—audio, video computer parts. **ALLKIT**, 434 W. 4th St., West Islip, NY 11795.

"CB Trick of the Trade book". Learn CB repair tricks and transmitting theory. Send \$19.95 to **MEDICINE MAN**, CB P.O. Box 37, Clarksville, AR 72830.

SPECIALTY circuits/computer programs designed for your projects send \$2.50 for details to **DESIGN SPECIALTIES**, RD #1, Box 117-A, Weirton, WV 26062.

CABLE-TV

WE'LL MATCH OR BEAT ANYONE'S ADVERTISED RETAIL OR WHOLESALE PRICES!

BONANZA!

ITEM	1 UNIT	10 OR MORE
RCA 36 CHANNEL CONVERTER (Ch. 3 output only)	29.00	18.00
PANASONIC WIRELESS CONVERTER (our best buy)	88.00	69.00
400 OR 450 CONVERTER (manual fine tune)	88.00	69.00
JERROLD 400 COMBO	169.00	119.00
JERROLD 400 HAND REMOTE CONTROL	29.00	18.00
JERROLD 450 COMBO	199.00	139.00
JERROLD 450 HAND REMOTE CONTROL	29.00	18.00
JERROLD SB-ADD-ON	89.00	58.00
JERROLD SB-ADD-ON WITH TRIMODE	99.00	70.00
M-35 B COMBO UNIT (Ch. 3 output only)	99.00	70.00
M-35 B COMBO UNIT WITH VARISYNC	109.00	75.00
MINICODE (N-12)	89.00	58.00
MINICODE (N-12) WITH VARISYNC	99.00	62.00
MINICODE VARISYNC WITH AUTO ON-OFF	145.00	105.00
ECONOCODE (minicode substitute)	69.00	42.00
ECONOCODE WITH VARISYNC	79.00	46.00
MLD-1200-3 (Ch. 3 output)	99.00	58.00
MLD-1200-2 (Ch. 2 output)	99.00	58.00
ZENITH SSAVI CABLE READY	175.00	125.00
INTERFERENCE FILTERS (Ch. 3 only)	24.00	14.00
EAGLE PD-3 DESCRAMBLER (Ch. 3 output only)	119.00	65.00
SCIENTIFIC ATLANTA ADD-ON REPLACEMENT DESCRAMBLER	119.00	75.00

*CALL FOR AVAILABILITY

Quantity	Item	Output Channel	Price Each	TOTAL PRICE
			SUBTOTAL	
			Shipping Add \$3.00 per unit	
			COD & Credit Cards — Add 5%	
			TOTAL	

California Penal Code #593-D forbids us from shipping any cable descrambling unit to anyone residing in the state of California.

Prices subject to change without notice.

PLEASE PRINT

Name _____

Address _____ City _____

State _____ Zip _____ Phone Number () _____

Cashier's Check Money Order COD Visa Mastercard

Acct # _____ Exp. Date _____

Signature _____

FOR OUR RECORDS:

DECLARATION OF AUTHORIZED USE — I, the undersigned, do hereby declare under penalty of perjury that all products purchased, now and in the future, will only be used on cable TV systems with proper authorization from local officials or cable company officials in accordance with all applicable federal and state laws. **FEDERAL AND VARIOUS STATE LAWS PROVIDE FOR SUBSTANTIAL CRIMINAL AND CIVIL PENALTIES FOR UNAUTHORIZED USE.**

Dated: _____ Signed: _____

Pacific Cable Company, Inc.

7325 1/2 RESEDA BLVD., DEPT. # R-6 • RESEDA, CA 91335
(818) 716-5914 • No Collect Calls • (818) 716-5140

IMPORTANT: WHEN CALLING FOR INFORMATION
Please have the make and model #. of the equipment used in your area. *Thank You.*

© Copyright 1987 PACIFIC CABLE CO., INC.

JUNE 1988

Are you tired of paying outrageous fees? Then let us provide you with a Converter or Descrambler that will entertain you, and your family for hours.

For Your FREE CATALOG write:

INTERNATIONAL VIDEO IMPORTERS
8867 Highland Rd
Baton Rouge, LA 70808

or call on our **24-hour HOTLINE (800) 642-6866**

We also offer Security and Survival books for full list send large (#10) S.A.S.E.

AWSOME light sequencer with unbelievable sound sync. Plans, board, cpu \$39.95; complete and tested unit \$199.95. **DUCK INDUSTRIES**, 27 Linda, Colonia, NJ 07067.

PRINTED circuit artwork kit-Convert your ideas to electronic reality-complete step-by-step instructions and materials for making 1:1 exposure ready artwork positives-single or double sided PC board-\$24.95-VISA/MC (include card no. and expiration date) / Check or M.O. We pay tax, postage. Another quality product by **CXT INC.**, 313 E. Walnut, Wheeling, IL 60090.

KITS*parts*plans. We have hard to find parts! Variable tuning capacitors, tuning coils, crystal headphones, germanium diodes, shortwave, crystal, CB radio kits (no soldering). Very inexpensive. Send large SASE for catalog. **YEARLY COMMUNICATIONS**, 12922 Harbor #800, Garden Grove, CA 92640.

SCRAMBLING news. New series **SSAVI-SAVVY** and **KEYS-R-US CHIPS**. \$24.95/yr. Samples (refundable) \$3. Box 1732, Niagra, NY 14302.

Multi-Channel Microwave T.V. Receivers

1.9-2.7 GHz Parabolic Dish 40+ dB Gain
LIFETIME WARRANTY
Complete System \$99.95 (Shipping Incl.)
Replacement Components & Expert Repairs Available

K & S ELECTRONICS Call now for same day shipping!
P.O. BOX 34522 PHOENIX, AZ 85067 (602) 230-0640

VISA/MC/COB \$2 CREDIT ON PHONE ORDERS

SATELLITE TV

VIDEOCYpher II descrambling manual, schematics, both video and audio encoding, DES, cloning, musketeering, EPROM codes. (HBO, Cinemax, adult channels.) \$13.95, \$1 postage. **CABLETRONICS**, Box 30502R, Bethesda, MD 20814.

RADIATION MONITOR
continued from page 48

printed-circuit board in the high-voltage section. In addition to being a safety precaution, the coating protects against humidity that might cause leakage in the high-impedance regulator circuit.

The two printed-circuit boards mate together through a 16 pin connector. Make sure the high voltage capacitors, C20-C24, are bent over to provide at least a 0.2-inch clearance between them and the top board.

Short leads

Clip the component leads very close in the area of the top board that is adjacent to the Geiger tube. Use care when handling the Geiger tube because both the mica window and the glass evacuation bulb adjacent to the anode connector are delicate. Install the Geiger tube after all other components have been soldered to the bottom board. Connect the Geiger tube's anode—the terminal with the solder lug—to the printed-circuit board through a 3/4-inch length of

DESCRAMBLING, new secret manual. Build your own descramblers for cable and subscription TV. Instructions, schematics for SSAVI, gated sync, sinewave. (HBO, Cinemax, Showtime, etc) \$8.95, \$1 postage. **CABLETRONICS**, Box 30502R, Bethesda, MD 20814.

CATALOG free for asking plans and kits for computers, radio, audio and video. **F.T.A.**, Box 574-A, White Plains, NY 10603.

DETECTION—surveillance, debugging, kits. Latest high-tech. Catalog \$2.00. **DETECTION SYSTEMS**, 2515 E. Thomas, Suite 16-864, Phoenix, AZ 85016.

insulated wire. The wire already welded to the Geiger tube is the cathode. The tube is positioned in the cut-out space of the bottom board and is held in place by double-faced adhesive foam on the bottom of the case. Insulate the Geiger tube from the top board with a small piece of fish paper or other insulating material rated for at least 1000-volts DC insulation. Make sure the tube is insulated from all components and the PC board. If necessary, trim your cabinet so the boards and switches fit properly.

Testing

Make sure all leads are trimmed close to the printed-circuit board. Look for cold solder joints and solder bridges between traces before turning the power on. Measuring battery drain will usually reassure you that everything is connected properly; the current should be between 100 and 150 microamperes.

Check the regulated 5-volt supply at IC18 pin 2. Check the 525-volt regulated high-voltage supply at the Geiger tube's anode if you have a meter having an input resistance of at least 10 megohms. (A lower resistance will load down the power supply, causing a false voltage drop.)

After testing is complete and voltages are correct, apply the conformal coating previously described.

Using the Radalert

Now that you have the Radalert operating, it's time to put it to work. But that's another story, and it's found in the following article. **R-E**

JUST SIMPLY PUT . . .
"When you're looking for a company that provides service and up-to-date technical advances, call us. That's what we're here for."
800-85-AMCOM

CABLE EQUIPMENT

NEW Super Z-TAC ADD-ON
ELIMINATES LINE 20 FALSE FLASHING
AUTOMATICALLY HANDLES NORMAL & INVERTED VIDEO. NO SWITCHES.
\$219.00

Standard SSAVI ADD-ON
CH #3 IN CH #3 OUT
VHF TUNER \$149.00
NO BLOCK CONVERTER
5 UNITS \$130.00 10 UNITS \$110.00
50 UNITS \$100.00 100 UNITS \$ CALL

INTERFERENCE FILTERS \$15.00
CHANNEL #2, 3, 8, 9, 17 ONLY
ADVANCED TRIMODE ADD-ON \$99.00

TV TUNER VARACTORS
VHF/MID/UHF MITSUMI \$25.00
UHF ONLY MITSUMI \$ 5.00

TOCOM

THIS KIT WORKS ON ALL TOCOM SYSTEMS.
CHANNEL #3 IN/CHANNEL #3 OUT.
BUILD IT YOURSELF AND SAVE.

Assembled and tested **\$150.00**
Kit includes all parts **\$9.00**

TEN-TEC DW-12
Metal Enclosure
W = 10"
L = 10.25" **\$22**
H = 4.50"
WITH HARDWARE

"BLASTER" \$25.00
UHF PREAMP KIT
25 db gain with only .5 NF loss when mass mounted.
USES PHANTOM POWER STRIPLINE CIRCUITRY

WALL PWR SUPPLIES

24 VAC 525 MA N/C .50
12 VAC 600 MA W/C 2.00
12 VAC 265 MA W/C 1.75

UHF SSAVI UNIT
w/power supply **\$40.00**

ORIGINAL Z-TAC AND SSAVI POWER SUPPLY \$15.00

LINEAR	CMOS	OTHER	RARE IC CHIP
LM318 80 MC1210 1.00	CD4002 20 CD4007 25	CD4520	CAMERA SYNC CHIP
LM319 80 MC1302 75	CD4011 15 CD4040 55	CD4526	SUPPLIES ALL SYNC
LM324 25 MC1390 1.25	CD4012 25 CD4047 55	7490	AND COLOR INFO
LS353 80 CA1398 4.00	CD4013 25 CD4053 55	74LS04	ONLY
LM358 1.25 MC1468 25	CD4015 25 CD4058 25	74LS74	
LM393 40 LM1498 75	CD4016 25 CD4060 20	74LS123	
LM393 25 LM1498 1.00	CD4017 25 CD4071 20	74C006	
LM365 75 TL082 75	CD4018 40 CD4081 25		
NE562 75 TL084 1.25	CD4024 40 CD4082 20		

DEALERS WANTED!! GREAT QUANTITY PRICES

AMCOM
P. O. Box 68391
Virginia Beach, VA 23455
804-456-5505 (TECHNICAL)
800-852-6266 (ORDERS ONLY)

UPS DAILY
COD ACCEPTED
MINIMUM ORDER \$15.00
CALL ANYDAY BEFORE 3 PM
ORDER WILL BE SHIPPED THAT DAY.
NO INSTATE SALES

RADIO-ELECTRONICS

*****SCRAMBLING NEWS***
PAY TV AND SATELLITE DESCRAMBLING**

Schematics, theory, bypasses 13 cable, 7 satellite. New SA turn-on. MLD-1200-3 \$14.95. Experiments With Videocipher Cloning, musketeering \$14.95. Cable TV Security design \$12.95. MDS MMD5 Handbook Microwave hacking 99.95. Build Satellite Systems Under \$600 \$12.95. Any 3/327. Scrambling News, Monthly. Feature articles, product reviews, law history, patents. \$24.95/yr. Sample \$5. Catalog \$1. PTV vol. 2 \$12.95.

Shojiki Electronics Corp. 1327A Niagara St.
Niagara Falls, NY 14303. COQ's 716 284-2163

CABLE TV Secrets—the outlaw publication the cable companies tried to ban. HBO, Movie Channel, Showtime, descramblers, converters, etc. Supplier's list included \$8.95. **CABLE FACTS**, Box 711-R, Pataskala, OH 43062.

SATELLITE TV receiver kits! Instruction manual, boards, semiconductor parts! 59' LNAs! LNBs! Ku-Band LNBs! Catalog \$1.00 (refundable): **XANDI ELECTRONICS**, Box 25647, Dept. 21FF, Tempe, AZ 85282.

DESCRAMBLERS for movies, networks, \$149. video only. \$399 complete. Catalog \$4 **SKYWATCH**, 238 Davenport Road, Toronto, Ontario, Canada, M5R-1J6.

DISHES systems upgrades, Chaparral, Drake, Houston, etc. **SAVE \$\$\$\$** Toll free, (800) 334-6455 **SKYVISION**, 2066R Collegeway, Fergus Falls, MN 56537

SCRAMBLE FACTS
718-343-0130

PHONE TODAY for 3 minutes of satellite TV industry news, technical tips, and new product information.

Big Profits!
LEARN VCR CLEANING-REPAIR. Prior Experience UNNECESSARY. Need only small hand tools & average mechanical abilities. **BIG DEMAND** performing VCR cleaning and repairs. **REAL EXAMPLES** of VCR malfunctions and their solutions. Photos and illustrations. ALSO: Information on starting your own business.

Free information: Write:
Vicjo VCR Repair
23010 Lake Forest Dr. #155
Laguna Hills, CA 92653
(714) 768-1925

BUSINESS OPPORTUNITIES

EARN thousands with your own part time electronics business. I do. Free proof, information. **INDUSTRY**, Box 531, Bronx, NY 10461.

EASY, lucrative. One man CRT rebuilding machinery. Free info: (815) 459-0666 **CRT**, 1909 Louise, Crystalake, IL 60014.

MECHANICALLY inclined individuals desiring ownership of small electronics manufacturing business—without investment. Write: **BUSINESSES**, 92-R, Brighton 11th, Brooklyn, NY 11235.

Big Profits!
ELECTRONIC ASSEMBLY BUSINESS

Start home, spare time, investment knowledge or experience unnecessary. **BIG DEMAND** assembling electronic devices. Sales handled by professionals. Unusual business opportunity.

FREE: Complete illustrated literature
BARTA, RE-O Box 248
Walnut Creek, Calif. 94597

YOUR own radio station! AM, FM, TV, cable. Licensed/unlicensed. **BROADCASTING**, Box 130-F6, Paradise, CA 95967.

PROJECTION TV...Make \$\$\$s assembling projectors...easy...results comparable to \$2,500 projectors... Total cost less than \$30.00. Plans, 8" lens and dealers information \$20.50... Illustrated information free. **MACROCOMA GJX**, Washington Crossing, PA 18977. Creditcard orders 24hrs (215) 736-2880.

CABLE T.V. "BOXES"

Converters—Descramblers
Remote Controls—Accessories

★ **Guaranteed Best Prices** ★
★ **1 Year Warranty—C.O.D.'s** ★
★ **Immediate Shipping** ★
★ **FREE CATALOG** ★

Call or Write
TRANS-WORLD CABLE CO.
12062 Southwest 117th Court, Suite 126
Miami, Florida 33186
800-442-9333

DIGITAL CAR DASHBOARDS

BUILD yourself complete electronic dashboards. Instruction manual: \$14.45; details free. **MODERN LABS**, Dept. 12V, 2900 Ruisseau, St. Elizabeth, QC, J0K 2J0, Canada.

PRINTED CIRCUIT BOARD LAYOUTS

GUARANTEED low pricing for single, double sided artwork layouts. (704) 464-1164. **PCBAL, RT-3**, Box 662-H, Conover, NC 28613.

300W HQ HI-FI POWER AMPLIFIER (MONO)
TA-3600 **NEW**

QUASI-COMPLEMENTARY-SYMMETRY WITH PARALLEL HIGH OUTPUT TRANSISTORS! SPECIFICATIONS:

- *POWER OUTPUT: 300W (RMS) INTO 8 OHMS 245W (P.M.P.O.) INTO 8 OHMS
- 540W (MUSIC POWER) INTO 8 OHMS
- *LOAD IMPEDANCE: 4 OHMS OR 8 OHMS
- *FREQUENCY RESPONSE: 10Hz-200,000Hz
- *TOTAL HARMONIC DISTORTION LESS THAN 0.05%
- *INPUT SENSITIVITY AND IMPEDANCE AT 1KHz: 1V-1.5V 47K OHMS
- *SUPPLY VOLTAGE: DC ±75V OR AC 53V x 2 BA
- KIT/ASM WITH TESTED \$80/92
- X'FORMER (WEIGHT: 15 lb) \$30.00

8 Digit 1GHz Multifunctional Counter
FC-1000A **NEW**

A versatile laboratory bench digital counter with FIVE FUNCTION performance: FREQUENCY, PERIOD, UNIT (TOTALIZE), DATA HOLD & SELF-CHECK. The period function makes the instrument outstanding for video tape recorder service applications. 0.5" Bright LED display assure easy readability of values. High stabilized dual crystal oscillators are used to ensure the accuracy in measurement. Durable alloy cabinet with a fancy looking panel. Comes complete with test lead and owners manual.

FEATURES:
Frequency range: 10Hz-10MHz GUARANTEED, 5Hz-1.2GHz typically
Input sensitivity: 10Hz-100MHz (10mV-32mV)
100MHz-1.2GHz (15mV-20mV)
Period range: 0.5µs-10µs
Unit counting capacity: 99999999
Accuracy: ±1 count, ±1ms base accuracy
Hold function: Hold the last input signal (Max. 8 digits)
Power source: 117V AC (100-50-50Hz)
Dimensions: 9.59"(W) X 8.7"(D) X 3"(H)
ASSM. WITH TESTED & CAL. \$188.00

NF-CR BI-FET PRE-AMP TA-2800 **NEW**

WITH TREBLE, MID-RANGE AND BASS 3 WAY TONE CONTROL

Match with TA-477 TA-3600 or other main power \$44.50

0-15V 2A REGULATED DC POWER SUPPLY
TR-100A

- Output voltage is adjustable from 0-15V DC, two current limit range are available for selection: 200mA or 2A
- An elaborated protection system is specially designed, a 'BB' sound and a sparkle light will appear when the output is overloaded.
- High stability and reliable resulting from employing high quality voltage regulate IC.
- 3/4" x 3 1/8" king size meter makes the reading of voltage and current more clearly and accurately.
- A metal case, meter and all accessory are enclosed for both kit and assembly form. Most suitable for factory, professional or even amateur.

Ass. with tested \$69.50

MARK V ELECTRONICS INC.
8019 E. SLAUSON AVE.
MONTEBELLO CA 90640
TELEX: 3716914 MARK 5

1-800-423-3483
TOLL FREE
Only for orders paid by Master or Visacard
MasterCard
IN CAL.: 1-800-521-MARK

INFORMATION: (213) 888-8988

FREE BALL POINT-PEN
WITH ANY PURCHASE

FREE 9 1/4" FLYER
WITH EVERY PURCHASE OF \$100 OR MORE
(AVAILABLE UNTIL STOCKS LAST)

WALK IN FOR YOUR FREE GIFT

100W DYNAMIC CLASS "A" MAIN POWER AMPLIFIER
TA-1000A **NEW**

KIT \$51.95
METAL CABINET/X'FORMER \$26/\$16.80

ELECTRONIC ECHO AND REVERBERATION AMPLIFIER
TA-2000A **NEW**

Ass. with tested \$99.85

RECORDS W/ ECHO EFFECT YOURSELF!

OVER 5000'S SOLD!

We've rated our goods with a **Δ** indicating the level of difficulty for kit assembly:
 Δ beginner Δ intermediate level;
 ΔΔΔ advanced level;
 * indicates the product has already been assembled.

FREE CATALOG

DIGITAL MENO TA-28 **NEW**

NO TAPE REQUIRED
Message Reminder!

SPECIFICATIONS:
16 SEC. RECORD TIME * LED FUNCTION INDICATOR *
AUTO RECORD CIRCUIT * INTERNAL 256K ORAM MEMORY *
INTERNAL MIC AMPLIFIER * ONE PUSH ON/OFF POWER *
TWO RECORD FUNCTION TALK-BACK MODE & MESSAGE MODE *
LOW POWER CONSUMPTION * SUPPLY VOLTAGE: 9V 20MA D.C.
KIT/ASM WITH TESTED \$20/30

HIGH QUALITY PRE-AMPLIFIER WITH 10 BAND EQUALIZER TA-2500 **NEW with CD input stage**

Ass. with tested \$90.00

PROFESSIONAL COLOR LIGHT CONTROLLER SM-328 **NEW**

FEATURES:
1. FOUR GROUPS OF INDEPENDENT OUTPUT SYSTEM 1000W/CH. MAX. 4880W (100-117V) 2. PROFESSIONAL COLOR CONTROL SYSTEM (KEYBOARD TYPE) 3. INDEPENDENT INPUT SIGNAL ADJUSTMENT 4. FOUR GROUPS OF INDEPENDENT DIMMER CONTROL 5. SPEED CONTROL 6. AUTOMATIC CHASING CONTROL SYSTEM 7. FOUR KINDS OF SPECIAL CHASING PROGRAM 8. COMBINATION OF PROGRAM AND MUSIC CHASING EFFECT 9. FORWARD/BACKWARD CHASING CONTROL. SM-328 color light controller is specialized for ballroom, night club disco and advertisement lighting. It consorts with several color control characteristics, which employ professional color control system and keyboard program selection. Therefore, it is capable of producing lighting effects by using chasing program and fluctuating music signal. There are two kinds of lighting effects. The first type is controlled by 'music' signal. In order to adjust the brightness of four groups of lightings, each music signal will be separated into high, medium low A, and low B frequency range. Furthermore, each group of lightings is incorporated with an independent signal adjustment. The second kind is composed of electrical circuits and this is the main part for creating a special lighting effect. It has four chasing programme.
Dimensions: 14 5/16" x 8 15/16" x 3 3/16"
Ass. with tested \$150.00 **ONLY**

OFFICE HOURS: (PACIFIC TIME)
MON.—FRI.: 9:30 to 5:00 SAT. 10:00 to 5:00

TERMS: \$10 min order • \$20 min charge card order • Check, money order or phone order accepted • We ship UPS Ground • Add 10% of total order (min \$2.5) for shipping, outside USA add 20% (min \$5.00) • Transit insurance, add 5% of total invoice (USA only) • CA residents add sales tax • All merchandise subject to prior sale • Prices are subject to change without notice • Any goods proved to be defective MUST BE RETURNED IN ORIGINAL FORM WITH A COPY OF YOUR INVOICE WITHIN 30 DAYS FOR REPLACEMENT.

Cable TV Converters

Why Pay A High Monthly Fee?

Jerrold Products include "New Jerrold Tri-Mode," SB-3. Hamlin, Oak VN-12, M-35-B, Zenith, Magnavox, Scientific Atlanta, and more. (Quantity discounts) 60 day warranty. For fast service C.O.D. orders accepted. Send SASE (60 cents postage) or call for info (312) 658-5320. **MIDWEST ELECTRONICS, INC.**, 5143-R W. Diversey, Chicago, IL 60639. MC/Visa orders accepted. No Illinois orders accepted. Mon.-Fri. 8 A.M.-5 P.M. CST

ROBOTIC SENSORS

TACTILE and pressure sensors, \$5/element, singles and arrays available. For info, send address to: **RECEPTOR TECHNOLOGY INC.**, 2 Kenwood Street, Somerville, MA 02144.

CABLE TV CONVERTERS

CABLE TV converters. Scientific Atlanta, Jerrold, Oak, Zenith, Hamlin. Many others. "New" Video Hopper "The Copy Killer." Visa, M/C & Amex. 1-(800) 826-7623. **B&B INC.**, 4030 Beau-D-Rue Dr., Eagan, MN 55122.

EDUCATION & INSTRUCTION

F.C.C. Commercial General Radiotelephone license. Electronics home study. Fast, inexpensive! "Free" details. **COMMAND, D-176**, Box 2223, San Francisco, CA 94126.

ENGINEERING software for IBM-PC. CompDes...circuit design. CompMath... math tutor. CompView...digital signal analysis. \$49 each. (614) 491-0832. **BSOFT SOFTWARE**, 444 Colton Road, Columbus, OH 43207.

100 FCC actual sample test questions. \$10 and 500 SASE. **PEI**, Box 12056-RE, Omaha, NE 68152.

IDEAL school projects. KIR-1 stereo image expander \$97. KVSP-1 stereo synthesizer \$92. Plans \$1.00. **SOUND CONCEPTS**, Box 135, Brookline, MA 02146 (617) 566-0110.



TUBES - 2000 TYPES DISCOUNT PRICES!
Early, hard-to-find, and modern tubes. Also transformers, capacitors and parts for tube equipment. Send \$2.00 for 20 page wholesale catalog.

ANTIQUE ELECTRONIC SUPPLY
688 W. First St. • Tempe, AZ 85281 • 602/894-9503

INVENTORS

INVENTORS! Can you patent and profit from your idea? Call **AMERICAN INVENTORS CORPORATION** for free information. Over a decade of service. 1-(800) 338-5656. In Massachusetts or Canada call (413) 568-3753.

DESCRAMBLER MODULE

COMPLETE cable-TV decoder in a mini-module. Latest technology upgrade for Jerrold SB-3 or Radio-Electronics Feb. 1984 project. Versatile, sophisticated, and low cost. For literature, **SOUTHTECH DISTRIBUTING**. (813) 527-2190.

WANTED
INVENTORS! AIM wants—ideas, inventions, new products, improvements on existing products. We present ideas to manufacturers. **Confidentiality guaranteed.** Call toll free 1-(800) 225-5800.

INVENTIONS, ideas, new products wanted! Industry presentation/national exposition. Call free 1-(800) 288-IDEA. Canada, 1-(800) 528-6060. X831.

GET OUT OF THE DARK.

Open your eyes and see just how many subjects are covered in the new edition of the Consumer Information Catalog. It's free just for the asking and so are nearly half of the 200 federal publications described inside. Booklets on subjects like financial and career planning; eating right, exercising, and staying healthy; housing and child care; federal benefit programs. Just about everything you would need to know. Write today. We'll send you the latest edition of the Consumer Information Catalog, which is updated and published quarterly. It'll be a great help, you'll see. Just write.

Consumer Information Center
Dept. TD, Pueblo, Colorado 81009

U.S. General Services Administration

CPU's & CHIPS				RAM'S			
V209	14.95	2.75	8.00	2M1203	3.00		
8080A	2.75	8.00	7.50	2M1623	7.00		
Z80A CPU	1.75	8.15	2.75	2M16	20.16		
Z80A CPU	3.75	8.15	2.75	2016	1.50		
Z80A CTC	1.95	8.202	3.00	2101A-4	1.50		
Z80A DART	15.25	8.203	18.00	2111A	1.75		
Z80A DMA	5.50	8.212	1.45	2112-1	1.95		
Z80A P10	1.95	8.214	3.75	2114	2.00		
Z80A S10	5.50	8.216	1.50	2115-4	1.75		
Z808 S10	9.95	8.226	2.25	2143-D	2.50		
82C43	4.75	8.226	1.60	3242	6.00		
AMD2901	4.00	8.237-5	6.50	TK50309	1.75		
8502	2.75	8.238	3.95	MK4029-3	3.00		
6552	3.50	8.2508	6.75	TK5406DL	1.75		
6800	1.75	8.251-A	2.40	TK4096B-11	1.25		
6802	4.50	8.253	1.75	4108-3	1.60		
6803L	8.00	8.255-A-1	1.85	4118-2	7.00		
6909	5.50	8.257	2.40	4118-A	1.75		
6810	1.75	8.259	2.40	4164-15	4.00		
6821	1.75	8.272A	4.75	4464-15	7.50		
6845	4.50	8.275	9.00	MK4802	6.00		
6850	1.75	8.279-5	2.75	26104-4	2.50		
6875	4.50	8.284	2.50	6116-3	1.60		
8001AH	3.75	8.288	4.75	6167P-3	4.50		
8035	1.75	8.355	12.95	6264L-15	5.50		
8048	5.00	8.378	6.75	2143-D	2.50		
8049	2.50	TMS5927NL	9.95	41256-12	6.00		
8095A	2.75	68000LH	8.50	41256-15	6.75		

SCR'S				TRIAC'S			
1.5A	6A	35A	76A	PRV	10A	25A	
100	35	40	140	100	35	80	140
200	40	50	180	200	50	80	190
400	60	70	240	400	70	100	260
600	90	100	300	600	100	120	320

RCA HC 2500				PAL'S			
60 WATTS	\$34.95	16L2	1.50	50	1.95		
SOLID STATE HYBRID		16R4	1.95				
LINEAR AND AUDIO AMP		16RB8	2.75				
BAND WIDTH 30 KHz at		16L8A	3.50				
60 WATTS, 7 AMP OUTPUT		20R8A	1.95				

ADD 10% FOR ORDERS UNDER \$25.00. ADD 5% FOR ORDERS BETWEEN \$25.00 AND \$50.00. ADD 3% FOR ORDERS ABOVE \$50.00.

SOLID STATE SALES TEL: (617) 547-7053 FAX: 617-354-1417
P.O. BOX 74D - SOMERVILLE, MASS. 02143 TOLL FREE 1-800-343-5230
FOR ORDERS ONLY WE SHIP OVER 95% OF OUR ORDERS WITHIN 24 HOURS OF RECEIPT

RADIO-ELECTRONICS

PARTS and more parts

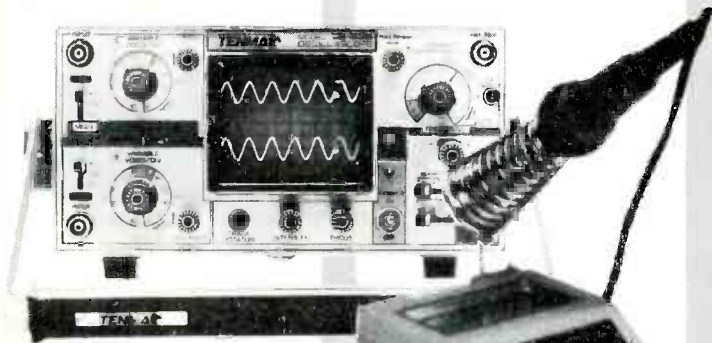

TENMA 15MHz Dual Trace Portable Oscilloscope

■ Dual trace model capable of displaying signals up to 15MHz, for up to two hours on a single charge of its internal battery ■ Power can be supplied from either a 12VDC or 120/240V 50/60Hz AC source
#72-335

TENMA Soldering Station

■ Adjustable temperature range of 150°-420°C (300°-790°F) ■ Grounded tip for soldering static sensitive devices ■ Overheat protection with closed loop temperature control ■ Replaceable iron clad tip ■ Improved circuit design for greater temperature stability
#21-147

TENMA Deluxe Anti-Static Desoldering Tool

■ Rugged metal construction ■ Anti-static tip ■ Nozzle cleaner ■ Lightweight and compact ■ Disassembles easily for cleaning ■ 7/8" long x 3/4" diameter
#21-590

TENMA LCR Meter

■ LCR Meter provides a convenient way to accurately measure inductance, capacitance and resistance (.01ohm resolution) on its 3 1/2 digit LCD display
#72-370

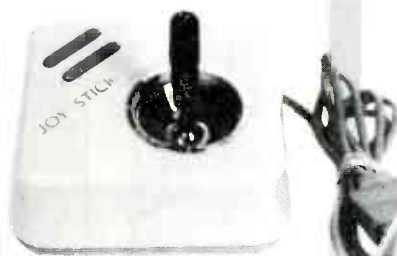

Deluxe Joystick for Atari and Commodore

■ For use with Atari, Commodore and other VCS compatible systems ■ Two firing buttons ■ 5.5' cord with 9 pin plug
#83-825



Super Wash

■ Powerful spray cleans intricate electronic assembly without harming plastics ■ Dries instantly ■ Spray literally blasts dirt and grease away ■ 24 oz.
#20-290



Tuner Cleaner

■ Cleans, lubricates, protects ■ Cleans and restores dirty and corroded contacts ■ Doesn't harm plastics ■ 16 oz.
#20-210



Diskette File Box

■ Stores up to 70 — 5 1/4" diskettes ■ Case made of anti-static ABS plastic with smoked acrylic cover ■ Six adjustable index dividers
#83-710



Anti-Static Work Mat

■ A must for the modern service shop. ■ Use in conjunction with our #21-660 wrist strap to help eliminate static related problems ■ 18" x 26"
#21-655



Anti-Static Wrist Strap

■ This wrist strap when used with our anti-static work mat, will effectively dissipate static charges ■ The five foot coiled cord with 1Mohm resistor, snaps to wrist strap to give user added mobility ■ Cord is terminated with a banana plug and alligator clip
#21-660



FREE CATALOG



CIRCLE 87 ON FREE INFORMATION CARD
MCM ELECTRONICS
858 E. CONGRESS PARK DR.
CENTERVILLE, OH 45459-4072
A PREMIER Company

Be sure to call for your
FREE catalog!
Over 10,000 items!
Call Toll Free
1-800-543-4330
In Ohio 1-800-762-4315
In Alaska 1-800-858-1849

© 1988, MCM Electronics

SOURCE CODE: RE-45

What's New at AMERICAN DESIGN COMPONENTS?

We warehouse 60,000 items at American Design Components — expensive, often hard-to-find components for sale at a fraction of their original cost!

You'll find every part you need — either brand new or removed from equipment (RFE) in excellent condition. But quantities are limited. Order from this ad, or visit our retail showroom and find exactly what you need from the thousands of items on display.

OPEN MON. — SAT., 9–5

THERE'S NO RISK!

With our full 90-day warranty, any purchase can be returned for any reason for full credit or refund.

ADAM COMPUTER



(Less printer)
No wiring necessary (just plugs together).
Hook-up diagram incl. Includes: keyboard, 1 cassette digital data drive, 2 game controllers, power supply & one cassette. Capable of running CP/M, has built-in word processor.
Item #7410 Complete — \$99.00

Accessories...

- DATA DRIVE — Item #6641 \$19.95
- PRINTER POWER SUPPLY — Item #6642 \$14.95
- ASCII KEYBOARD — Item #6643 \$19.95
- CONTROLLERS (Set of 4) — Item #7013 \$9.95 RFE
- ADAM CASSETTES — (Consisting of Smart Basic, Buck Rogers & blank cassette.) Item #7786
BAKER'S DOZEN — \$19.95
- ADAM LINK MODEM — (Software incl.) Item #12358 \$29.95
- DISK DRIVE POWER SUPPLY — Item #14603 \$14.95
- ADAM DAISY PRINT WHEEL — Item #13305 \$3.95

COLECOVISION TO ADAM EXPANSION KIT

Incl. printer power supply, data drive, Adam keyboard, 1 Smart Basic cassette & hook-up diagram.
Item #9918 \$59.50

COLECOVISION ACCESSORIES...

- Expansion Module #2 — Includes Turbo cartridge.
Item #13146 New — \$39.95
- Roller Controller — Includes Slither cartridge.
Item #13147 New — \$39.95
- Super Action Controller Set — Includes Baseball cartridge.
Item #13148 New — \$39.95

MICROCOMPUTERS with EPROM

MC68701
An 8-bit single chip unit that significantly enhances the capabilities of the M6800 family. TTL compatible, requires one +5V power supply for nonprogramming operation. Incl. 2048 bytes Eprom, 128 bytes RAM, serial comm. interface (SCSI), parallel I/O & 3-function programmable timer. Item #9496.
(house numbered) \$9.95



MC68705
HMOS, 8-bit, medium performance microcomputer. On-chip resources: 3776 bytes Eprom, 112 bytes RAM, 8 inputs & 24 programmable bidirectional out-puts. Self-programming boot strap.
Item #13608 \$9.95

3 1/2", 20 Mb, HALF-HEIGHT HARD DISK DRIVE



Fits standard 5 1/4" spacing. High speed, low power. Comes w/both full-ht. and half-ht. face plates.
Mfr — Lapine #LT200/2000
Item #15853 \$199.00 New

5 1/4", FULL-HEIGHT 10Mb HARD DISK DRIVE



ST412 Compatible.
Major manufacturers — **Get them while they last!**
Item #17199 \$99.00 ea.

5 1/4" FULL HEIGHT DISK DRIVES —

- 48 TPI (IBM® Compatible) DS/DD, 40 Track
Tandon #TM100-2 or equiv.
Item #7928 \$79.00 New
2 for \$150.00 New
- 48 TPI (TRS80/Zenith/Xerox 800 Compat.) DS/DD, 40Track
Shugart #450. Item #1892.
\$79.00; 2 for \$150.00
- 48 TPI, SS/SD, 40 Track
Shugart #SA400. Item #1895.
\$39.50; 2 for \$75.00
- 96 TPI, DS/Quad Density
CDC #9409T
Item #1893 \$89.00

3 1/2" MICROFLOPPY DISK DRIVE



1 Mb (unformatted), 135 TPI, 3 ms. access time. Power requirements: +12V, +5V. (Removed from operational computers — **Tested — Like New!**)
Mfr — NEC, model FD1035
Item #17171 \$79.00 ea.
2 for \$150.00

MINDSET® COLOR GRAPHICS Personal Computer System...

Fast graphics capabilities allow you to draw, animate & color objects instantly. 265K w/360K floppy disk drive. Contains built-in RGB/Monochrome card & TV adapter. Incl. mouse, joystick, GW BASIC & MS DOS 2.1.
Item #16077 New— \$299.00

ACCESSORIES...
★ RS-232 Module w/Power Option — Provides EIA standard RS-232-C serial interface.
Item #16080 New— \$39.95

RUNS ALL THE SAME PROGRAMS AS THE IBM® PC!

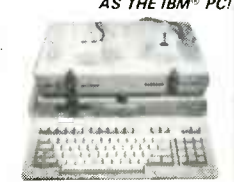

(Does not include monitor.)
★ NV RAM 8K Cartridge — Provides 8K non-volatile RAM.
Item #16078 New— \$29.95

EXTERNAL DISK DRIVE CHASSIS



With 60W power supply (fan cooled).
Can accommodate:
2 full ht. drives our item #7928
2 floppy drives — #1904
1 hard drive & 1 floppy #13250
Input: 115/230V, 50/60 Hz.
Originally from Burroughs computer.
Dim.: 11" W x 8" H x 12" deep
Item #14541 \$59.50

5 1/4", 1.2Mb HALF-HEIGHT DISK DRIVE



IBM® AT Compatible
48/96 TPI, 1.2 Mb
Double side, high density; 160 tracks. Mfr — Panasonic #JU-475
Item #10005 \$109.95 New

22" COMPOSITE MONITOR



Black & White, Raster Scan
Standard TV-grade monitor, originally used in arcade games, ignition systems, etc. 115VAC, 60Hz.
Mfr — Wells Gardner 22V1003A
Item #16579 \$49.95 New

LIGHT PEN IBM® PC Compatible...

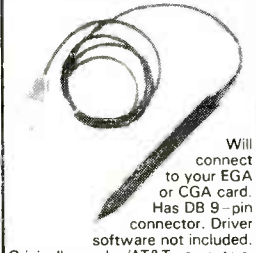

Will connect to your EGA or CGA card. Has DB 9-pin connector. Driver software not included. Originally used w/AT&T computers.
Item #16454 \$39.95 New

27 CFM MINI FANS



50/60Hz.; 12W. Low noise-level fans. Can be mounted for blowing or exhaust.
1" Thin — Contains 9 plastic blades. Dimensions: 3 1/8" sq. x 1" deep
Mfr — Toshiba #U9201B
Item #10960 \$7.95 RFE
- 1 1/2" Standard — Contains 7 metal blades. Mfr — Rotron #SU2A1
Item #5970 \$7.95 New

115 CFM MUFFIN® FANS



115VAC 60Hz, 21W, 28A, 3100 RPM, 5-blade model, aluminum housing. Can be mounted for blowing or exhaust.
Dimensions: 4 1/8" sq. x 1 1/2" deep
NEW — Mfr: IMC
Item #1864 \$9.95
USED — Mfr: Centaur/Howard
Item #5345 \$5.95

WE CARRY A FULL LINE OF COMPUTER & GAME EQUIPMENT and ACCESSORIES; ELECTRONIC COMPONENTS; MODULES!

NICAD BATTERY PACK (Rechargeable) 12V @ 450ma



Contains 10 AA cells. Recharge rate: 45 ma. 16–18 hours. Dim.: 2 1/8" H x 1 1/4" W x 2 1/8" L
Mfr — GE 123233 or equiv.
Item #5443 \$5.95 New

STEPPING MOTORS for ROBOTICS



Precision steppers with increments from 1 to 7.5°. Speeds up to 5,000 steps.
Shaft 1/2" L x 3/16" dia.
Fig. 1: 1 1/4" deep, 1 1/8" square, 3/16" dia.
Fig. 2: Shaft 1 1/4" L x 3/8" dia., Face Plate 5/8" sq., 2 1/4" deep.

Item No.	Step Angle	Volts DC	Torque (oz/in)	Type	Mfr. & Part No.	Fig	Price
5275	1.8	1.8	72	PM	Superior Electric MO61-FF-6201B	2	\$19.95 ea. / \$37.50
7630	1.8	3.0	200	PM	Superior Electric MO92-FI-402	2	\$34.50 ea. / \$59.50
16410	1.8	12.0			Applied Motion Prod. 4017-839	1	\$12.95 ea. / 2/\$19.95

COMMODORE CARTRIDGES...

C-64
Consists of 8 assorted cartridges, incl.: Number Nabber, Star Post, Radar Rat, Jupiter Land, Viduzzles, Golf, Dragon's Den, & ABC Voice.
Item #13573
Set of 8 — \$39.95 New

C16 & +4
Consists of 8 assorted cartridges, including: Calc Plus, Script +, Jack Attack, Pirate Adventures, Atomic Miss, Strange Odyssey, Financial Advisor, & Logo.
Item #13572
Set of 8 — \$29.95 New

12V BATTERY PACK & MATING CHARGER



Consists of: 2 solid gell cell batteries, 6V @ 9.5Ah ea. Connected in series by a fusible harness. Mating battery charger: 12VDC @ 800Ma. Perfect for battery-operated toys, robotics, solar storage, burglar & fire alarms, etc.
OA Dim.: 4 1/4" W x 5 1/2" H x 5 1/2" D
Item #14619 \$29.95 New

COPPER-CLAD PRINTED CIRCUIT BOARD (Double-sided)

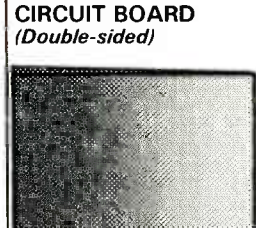

Glass coated, epoxy laminated, 1 oz. Double sided, .022" thick. Dimensions: 24" L x 18.5" H
Item #13606
3 sheets/ \$9.95

VOICE-ACTIVATED SWITCH



"Activate on' or off' with the sound of your voice, a whistle or clap..."
Ideal for robotics, lights, etc. Turns on with the first sound & off with the second. Solid-state units with adjust. sensitivity control & pick-up microphone attached to PC board.
Dim.: 2 3/4" x 3 1/4" x 7/8"
VOX input: 6–9VDC; can be used with any standard battery.
Item #16440
3 switches/ \$9.95

COMMODORE VIC 20 CPU BOARD

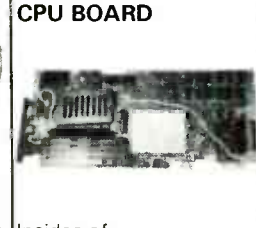

Insides of the Commodore VIC 20. For parts only — **Guaranteed not to work!**
Item #12144 \$14.95

"The First Source" — for electromechanical & electronic equipment and components — AMERICAN DESIGN COMPONENTS!

TTL MONITORS . . .
(Open Frame)



9" High-Resolution
12VDC, green phosphor. Schematic supplied. Mfr — Motorola MD2003-190.
Item #17198 **\$14.95** New

12" High-Resolution
12VDC, green phosphor. Subassemblies, CRT, board & transformer included. Comes with hook-up diagram.
Item #6811 **\$19.95** New

15" Data Display/ Monitor Kit
Alphanumeric & graphics display. Green phosphor. Input power reg. 24 VDC. Bandwidth: 22-72Khz. Consists of 2 subassemblies (monitor & board). Hook up diagram incl. Mfr — Wells Gardner #15V7025.
Item #16171 **\$24.95** New

★ ★ ★ ★ ★
TIMEX-SINCLAIR . . .
2040 PRINTER



32 column — compatible w/any of the Timex-Sinclair computers, as well as our PC 8300 Computer. Uses standard 4 1/2" thermal paper.
Item #15851 **\$39.95** New

COMMODORE/AMIGA POWER SUPPLY



DC Output: +5V @ 8 amps.
+12V @ 1 amp.
-5V @ 250 ma.
Input: 110VAC/60 Hz., ±20%
Dim.: 12"L x 3"H x 5 1/2"D
Encl. in alum. housing. Fan cooled.
Mfr — Shindenger Electric #130569SX
Item #14047 **\$19.95** New

INTEGRATED CIRCUITS . . .

STATIC RAMS

2114-45	1024 x 4 (450ns)	\$ 99	HM6116LP-3	2048 x 8 (150ns)	\$1.89
2148-55		3.49	HM6116LP-4	2048 x 8 (200ns)	1.85
2149	1024 x 4 (45ns)	2.49	6147P		2.95
21675-45		3.95	6167P-6		4.50

DYNAMIC RAMS

4116-200	16,384 x 1 (200ns)	\$ 69	TMS4416	16,384 x 4 (150ns)	\$3.75
4116-250	16,384 x 1 (250ns)	.49	4464-150	65,536 x 4 (150ns)	4.95
4164-150	65,536 x 1 (150ns)	1.25	8118	16,384 x 1 (120ns)	4.9
TMS4164	65,536 x 1 (150ns)	1.95	41256-150	262,144 x 1 (150ns)	8.00

EPROMS

2708	1024 x 8 (450ns)	\$4.95	2764-250	8192 x 8 (250ns)	\$3.55
2716	2048 x 8 (450ns)	3.49	MCM68766	8192 x 8 (350ns)	15.95
TMS2532	4096 x 8 (450ns)	5.95	27128A-250	16,384 x 8 (250ns)	5.00
2732	4096 x 8 (450ns)	3.95	27128-250	16,384 x 8 (250ns)	4.25
2732A-25	4096 x 8 (250ns)	3.95	27C256	32,768 x 8 (250ns)	7.95
27C64	8192 x 8 (250ns)	4.95	27256	32,768 x 8 (250ns)	5.95
2764	8192 x 8 (450ns)	2.95	27512	65,536 x 8 (250ns)	11.55
2764A-25	8192 x 8 (250ns)	3.55			

COMPUTER GRADE POWER SUPPLY



Other uses—runs CB & car radios. Comes ready to plug in!
DC Output: -5V @ 5 amp.
+5V @ 3 amp.
+12V @ 6 amp.
Input: 115V/60Hz. Dimensions: 9 1/2"W x 3 3/4"H. (Rubber ft. incl.)
Item #9501 **\$24.95** New

PC 8300 HOME COMPUTER
(Advanced version of the Timex 1000)



42-key mechan. keyboard
2K RAM.
Rev. video, Z80A, 6.5MHz processor, ROM
8K BASIC. Graphics cap./sound-music, TV or monitor. Joystick input.
115VAC. AC adapt, TV cable & cass. cables.
Runs tapes for Sinclair/Timax 1000-ZX85.
Mfr-Power 3000. In ong. boxes
Item #10336 **New - \$29.95**

★ **16K RAMPACK upgrade**
Item #10337 **New - \$9.95**

★ **32K RAMPACK upgrade**
Item #12148 **New - \$19.95**

5-WATT AUDIO POWER AMPLIFIER in a CHIP — SGS 830S



Freq. response: 40 to 10 KHz., .3% distortion. Input sensitivity: 50mV. Power requirements: 4 to 20 VDC. Ideal for building custom amplifiers, etc. Item #15390.
\$5.95 ea.; 2 for **\$10.00**

SMART WATCH DS 1216



DS1216 is a 28-pin, 6"-wide dip socket w/built-in CMOS watch function. Non-volatile RAM controller and lithium energy source. Accepts either 24-pin 2K x 8 or 28-pin 8K x 8 CMOS static RAM. Communication w/Smart Watch function is established by pattern recognition on a serial bit stream of 64 bits on D.O.
Mfr — Dallas Semiconductor
Item #15939 **New \$29.95**

LINEAR

LH0002CN	\$5.35	TL497ACN	\$1.97	7818K	\$1.21
LM10CLH	2.65	NE555V	.26	7824K	1.21
LH0070-OH	3.55	XR1555	.62	7805T	.44
TLO71CP	.53	LM558N	.53	7812T	.44
TLO72CP	.71	NE558N	1.07	7815T	.44
LM301N	32	NE564N	1.75	7818T	.44
LM307N	.41	LM565N	.90	7824T	.44
LM310N	1.16	LM566CN	1.25	78540	1.75
LM311N	.41	LM567V	.80	7905K	1.21
LM317K	2.65	NE570N	2.24	7906K	1.21
LM317LZ	.62	NE571N	1.75	7912K	1.21
LM317MP	.80	NE592N	.80	7915K	1.21
LM317T	.90	LM748CN	.53	7918K	1.21
LM319N	1.07	DSB728N	1.57	7924K	1.21
LM319N	1.07	LM1456V	1.75	7905T	.53
LM324N	.35	LM1458N	.44	7912T	.53
LM334Z	1.07	LM1488N	.62	7915T	.53
LM336Z	.98	LM1496N	.90	7918T	.53
LM337MP	1.03	LM1899N	1.43	7924T	.53
LM337T	1.34	ULN2003A	.90	79L12AC	.53
LM338K	3.55	DS26LS31CN	1.34	79L15AC	.53
LM339N	.44	DS26LS32CN	1.34	LF13201N	2.33
LF347N	90	LM2901N	.53	LM13600N	1.07
LM348N	.62	LM2903N	.53	LM1889	1.85
LM350K	3.55	LM2907N	1.75	75107N	.90
LF353N	.53	LM2917N	1.39	75108N	.90
LF356N	.80	LM2917-14N	1.34	75110A	1.34
LM358N	.44	LM2931CT	1.07	75115	1.07
LM380N	.80	MC3346P	.90	75123N	1.34
LM380N-8	.98	MC3486	1.34	75124N	1.34
LM391N	1.16	MC3487	1.34	75138N	2.65
LM393T	1.34	SG3524	1.75	75154N	1.25
LM385Z	1.70	LM3900N	.53	75450N	.53
LM386N-4	.80	LM3914N	1.75	75451CN	.44
LM389N	.90	RC4136N	.80	75452CN	.44
LM393N	.41	RC4151NB	.90	75453CN	.44
LF398N	2.15	RC4193NBIDE	2.65	75463N	.53
LF411CN	.71	7805K	1.21	75472	.80
TL494CN	1.75	7812K	1.21	75492N	.71
TL496CP	1.34	7815K	1.21	76477	3.55

SWITCHING POWER SUPPLY



DC Output: +5V @ 8A
+12V @ 500ma
-12V @ 200ma
+24V @ 2.0A
Input: 115/230VAC, 50/60Hz.
Dimensions: 8 1/2" x 4 1/2" x 2 1/4"
Mfr — Power Systems #PS1547
Item #16585 **\$19.95**

**PUMPS—COMPRESSORS—BLOWERS—MOTORS—POTENTIOMETERS—COUNTERS
TIMERS—RELAYS—VOLTAGE REGULATORS—POWER SUPPLIES**

ELECTRONIC CASH REGISTER DRAWER
(Can be Computer Operated)



Fits right underneath your PC. Comes w/removable cash drawer; and security switch w/keys, which allows you to open or lock the drawer manually. Cabinet is brown; mounted on rubber feet. Overall dimensions: 18 1/2"W x 4"H x 15" deep.
Item #12265 **\$59.50** New

NEON TRANSFORMER (Hi-Voltage)



7300VAC @ 5 Ma.
May be used for powering neon lights, replacing oil burner ignition transformer, building Jacob's ladder (spark gap). High-volt. output: 1/4" quick connect terminal & case ground input fully enclosed metal case. Wt.: 12 lbs.
Base mount: 4 1/2"H x 5 1/2"W x 6 1/2"
Item #151 **\$9.95** RFE

MAGNIFYING LAMP



Multi-position, 30", completely adjustable swing arm with 3-way metal C-clamp. Has 4" diopter magnifying lens, w/ruler. Porcelain lamp socket, & on/off switch; uses up to a 60W bulb. Color: Beige. UL listed.
Item #13136 **\$24.95** New

CRYSTALS (Microprocessor) HC-18U

Mhz.	Item #
1.8432	7915
3.2768	13911
3.579545	12361
4.0	7045
4.032	13041
5.0	13043
5.0688	6786
6.0	12362
6.144	13226
10.736835	1953
12.0	7920
13.7931	7362
14.31818	7359
16.0	13425
18.432	13227
20.0	12360
28.0	7389
122.666	7037

\$1.75 ea.

IC SOCKETS . . . (Low Profile)



No. of Pins	Item #	Price
8	13518	\$.11
14	7350	.12
16	7354	.13
18	13649	.15
20	7353	.18
24	1230	.20
28	12865	.22
40	7351	.30
64	16169	1.75

MINI MICRO-COMPUTER REGULATOR



140 VA

Provides voltage regulation & ultra-isolation for micro-processor-based equipment. Contains less than 3% harmonic distortion; better than 60 db traverse noise rejection. W/ dual output for CPU & monitor, and 6-ft. line cord.
Input: 95 - 130V, 60Hz.
Output: 120V @ 1.17A
Dimen.: 11 1/2"L x 4 3/4"H x 5 1/2"W
Mounted on metal base w/rubber feet.
Mfr — Sola #63-13-114
Item #9999 **\$89.00** New

AMERICAN DESIGN COMPONENTS, 62 JOSEPH STREET, MOONACHIE, N.J. 07074

YES! Please send me the following items:

Item No.	How Many?	Description	Price	Total
Total				

Shipping & handling, we ship UPS unless otherwise specified. Add \$3 plus 10% total.
Canadian: \$3 plus P.O. cost. Charge only.
Sales Tax (N.J. residents only, please add 6% of total)

ORDER TOTAL _____

FREE Fall Supplement with every order.

My check or money order is enclosed. **\$15**

Charge my credit card. **RE-688**

Visa Master Card Amex

Card No. _____
Exp. Date _____
Signature _____
Telephone: Area Code _____ Number _____
Name _____
Address _____
City _____
State _____ Zip _____

All inquiries and free catalog requests call 201-939-2710.

For all phone orders, call TOLL-FREE 800-524-0809. In New Jersey, 201-939-2710.

Mail Order Electronics - Worldwide

Jameco ELECTRONICS

Mail-Order Electronics ORDER HOTLINE 415-592-8097 ALL OTHER INQUIRIES 415-592-8121

NEC V20 & V30 CHIPS

Replace the 8086 or 8088 in Your IBM-PC and Increase Its Speed by up to 40%! Table listing V20 and V30 chips with Part No., Price, and 1-9 10+ prices.

7400

Table listing 7400 series chips with Part No., Price, and 1-9 10+ prices.

74LS

Table listing 74LS series chips with Part No., Price, and 1-9 10+ prices.

74S/PROMS*

Table listing 74S/PROMS chips with Part No., Price, and 1-9 10+ prices.

74F

Table listing 74F series chips with Part No., Price, and 1-9 10+ prices.

CD-CMOS

Table listing CD-CMOS chips with Part No., Price, and 1-9 10+ prices.

MICROPROCESSOR COMPONENTS

Table listing Microprocessor Components including Miscellaneous Chips, 8500/6800/68000 Cont., and 8000 Series Cont.

MICROPROCESSOR SALE!

Table listing Microprocessor Sale items with Part No., Description, and Price.

DYNAMIC RAMS

Table listing Dynamic RAMs with Part No., Description, Price, and Remarks.

STATIC RAMS

Table listing Static RAMs with Part No., Description, Price, and Remarks.

EPROMS

Table listing EPROMs with Part No., Description, Price, and Remarks.

SPECIALS!

Table listing Specials including SMP81FY, MAX232CPE, LM306P, 6116P-1, 27128-45, 74LS612, and 74HC HI-SPEED CMOS.

74HCT - CMOS TTL

Table listing 74HCT CMOS TTL chips with Part No., Price, and 1-9 10+ prices.

74C - CMOS

Table listing 74C CMOS chips with Part No., Price, and 1-9 10+ prices.

LINEAR

Table listing Linear chips with Part No., Price, and 1-9 10+ prices.

IC SOCKETS

Table listing IC Sockets with Part No., Price, and 1-9 10+ prices.

PARTIAL LISTING • OVER 4000 COMPONENTS AND ACCESSORIES IN STOCK! • CALL FOR QUANTITY DISCOUNTS *DRAM'S SUBJECT TO FREQUENT PRICE CHANGES

CIRCLE 114 ON FREE INFORMATION CARD

www.americanradiohistory.com

Worldwide • Since 1974

• QUALITY COMPONENTS • COMPETITIVE PRICING • PROMPT DELIVERY

Mail Order Electronics • Worldwide
Jameco
ELECTRONICS

PROTOTYPING PRODUCTS

Jameco Solderless Breadboard Sockets

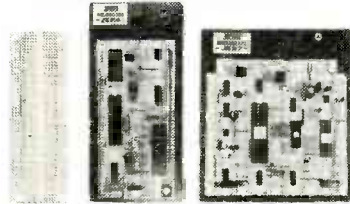

Part No.	Dim. L" x W"	Contact Points	Binding Posts	Price
JE20	6 1/2 x 3/4	200	0	\$ 2.29
JE21	3 1/4 x 2 1/8	400	0	\$ 4.49
JE22	6 1/2 x 1 3/8	630	0	\$ 5.95
JE23	6 1/2 x 2 1/8	830	0	\$ 7.49
JE24	6 1/2 x 3 1/8	1,360	2	\$14.95
JE25	6 1/2 x 4 1/8	1,660	3	\$22.95
JE26	6 7/8 x 5 3/8	2,390	4	\$27.95
JE27	7 1/4 x 7 1/2	3,220	4	\$37.95

Jameco's IBM PC/XT/AT Compatible Motherboards

Award BIOS ROMs included



JE1001

JE1000	4.77MHz (PC/XT)	\$ 84.95
JE1001	4.77/8MHz (PC/XT)	\$ 99.95
JE1002	4.77/10MHz (PC/XT)	\$119.95
JE1007	6/8/10/12MHz (AT)	\$349.95

2 & 3MB Memory Expansion Cards for IBM AT and Compatibles

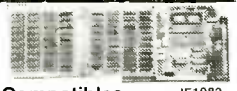

JE1082

JE1081	2MB of expanded or extended memory (zero-K on-board) (AT)	\$129.95
JE1082	3MB of expanded or extended memory, parallel printer port, serial port and game port (zero-K on-board) (AT)	\$169.95

Jameco Computer Power Protection



JE1190

JE1190	Power Base	\$29.95
JE1191	6-Outlet Power Strip	\$11.95

Zuckerboard

TANDY 1000 Expansion Memory Half Card

Expand the memory of your Tandy 1000 (128K Version) to as much as 640K. Also includes DMA controller chip.

TE512	Includes 512K RAM	\$199.95
-------	-------------------	----------

30Meg Hard Disk Drive Board for Tandy 1000, 1000A, 1000SX, 1200, 3000 and 3000HL	
30MB Hard Disk Drive Board	\$599.95

DATA BOOKS

400041	NSC Linear Data Book-Vol. I (87)	\$14.95
400042	NSC Linear Data Book-Vol. II (87)	\$ 9.95
400043	NSC Linear Data Book-Vol. III (87)	\$ 9.95
210830	Intel Memory Handbook (87)	\$17.95
230843	Intel Microsystem Hndbk. Set (87)	\$24.95

Jameco's New and Improved AT Compatible Kit!

FREE! Word Processing Software! New! Compact Case

IBM AT Compatible Kit Mini-286 6/8/10/12MHz Kit

JE1007	Baby AT Motherboard (Zero-K RAM - includes Award BIOS ROMs)	\$349.95
JE1015	XT/AT Style Keyboard	\$ 59.95
JE1017	Baby AT Flip-Top Case	\$ 69.95
JE1022	5 1/4" Hi-Density Disk Drive	\$109.95
JE1032	200 Watt Power Supply	\$ 89.95
JE1043	360K/720K/1.2M Floppy Controller Card	\$ 49.95
41256-120	512K RAM (18 Chips)	\$161.10

Regular List \$890.80

SAVE \$140.85! (EGA Monitor and Card not included - see below)

JE1009	IBM AT Compatible Kit	\$749.95
JE286M	JE1009 Technical Manual	\$29.95

IBM COMPATIBLE DISPLAY MONITORS

12" Amber Monochrome - TTL Input, High Resolution (PC/XT/AT) AMBER... \$109.95 \$99.95

14" RGB Color - CGA Compatible Amber/Green/Color Switchable, 640 x 200 Resolution (PC/XT/AT) TTX1410... \$279.95

14" EGA Color - EGA/CGA Compat., 720 x 350 (max.) resolution (PC/XT/AT) TE1514... \$399.95

15" Ultrascan Color - CGA/EGA/PGC/VGA Compatible, 800 x 560 (max.) Resolution (PC/XT/AT) 4375M... \$579.95 \$499.95

IBM PC/XT/AT COMPATIBLE CARDS

Graphic Display Cards



JE1059
EGA Card and Monitor
\$499.95

JE1050	Mono Graphics Card w/Printer Port (PC/XT/AT)	\$59.95
JE1052	Color Graphics Card w/Printer Port (PC/XT/AT)	\$49.95
JE1055	EGA Card with 256K Video RAM and Printer Port (PC/XT/AT)	\$149.95
JE1071	Multi I/O with Drive Controller and Mono Graphics (PC/XT)	\$119.95

Multifunction, I/O and Expansion Cards

JE1060	I/O Card with Serial, Game, Parallel Printer Port and Real Time Clock (PC/XT)	\$59.95
JE1061	RS232 Serial Half Card (PC/XT/AT)	\$29.95
JE1065	I/O Card with Serial, Game and Parallel Printer Port (AT)	\$59.95
JE1078	Expand to 384K (zero-K on-board) Multifunc. w/Serial, Game, Parallel Printer Port & Real Time Clock (PC/XT)	\$79.95

Floppy and Hard Disk Controller Cards

JE1040	360KB Floppy Disk Drive Controller Card (PC/XT)	\$29.95
JE1041	20/40MB Hard Disk Controller Card (PC/XT)	\$79.95
JE1043	360K/720K/1.2MB Floppy Disk Cont. Card (PC/XT/AT)	\$49.95
JE1045	360K/720K/1.2MB Floppy/Hard Disk Controller Card (AT)	\$159.95

Additional Add-Ons Available!

COMPUTER PERIPHERALS



Seagate 20, 30, 40 and 60MB Half Height Hard Disk Drives

ST225	20MB Drive only (PC/XT/AT)	\$259.95
ST225K	20MB w/Controller (PC/XT)	\$289.95
ST238	30MB Drive only (PC/XT/AT)	\$299.95
ST238K	30MB w/Cont. (PC/XT/AT)	\$329.95
ST251	40MB Drive only (PC/XT/AT)	\$439.95
ST251XT	40MB w/Cont. Card (PC/XT)	\$499.95
ST251AT	40MB w/Cont. Card (AT)	\$539.95
ST277	60MB Drive only (PC/XT/AT)	\$549.95
ST277K	60MB w/Cont. Card (AT)	\$659.95



JE1022 (Pictured)

JE1020	360K Black Bzl. (PC/XT/AT)	\$ 89.95
JE1021	360K Beige Bzl. (PC/XT/AT)	\$ 89.95
JE1022	1.2MB Beige Bzl. (AT)	\$109.95

Datronics

2400/1200/300 Modems



• Hayes command compatible • Bell 103/212A compatible • Auto-dial/auto-answer • FCC approved 1-year warranty • Includes MaxiMite Communication Software

1200H	1200/300 Baud Internal Modem	\$ 79.95
2400S	2400/1200/300 Internal Modem	\$174.95
1200C	1200/300 Baud External Modem	\$119.95
2400E	2400/1200/300 External Modem	\$219.95

Prometheus 1200B Internal Modem PM1200B-2S (Software incl.) \$149.95 \$119.95

Jameco Extended 80-Column Card for Apple IIe

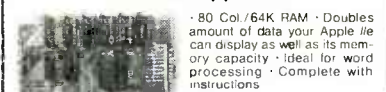

• 80 Column/64K RAM • Doubles amount of data your Apple IIe can display as well as its memory capacity • Ideal for word processing • Complete with instructions

JE864	\$39.95
ADD12	(Disk Drive II, II+, IIe) \$99.95

TEST EQUIPMENT

Kingdom and Metex Digital Multimeters



KD302:
• Pocket Size in handy carry case
• 3 1/2 Digit LCD
• Auto or manual ranging
• Audible continuity tester
• Tests AC/DC Voltage, Resistance and Continuity
• One Year Warranty
• Size: 7" L x 3" W x 1 1/2" H
KD302 ... \$27.95



M4650:
• Handheld, high accuracy
• 4 1/2 Digit LCD
• Manual ranging with Overload Protection
• Audible continuity tester
• Tests AC/DC Voltage, Resistance, Continuity, Capacitance and Frequency
• One Year Warranty
• Size: 7" L x 3" W x 1 1/2" H
M4650 ... \$79.95

U.S. Funds Only
Shipping: Add 5% plus \$1.50 Insurance
(May vary according to weight)

California Residents:
Add 6%, 6 1/2% or 7%
Sales Tax
FAX 415-592-2503
6/88



Data Sheets - 50¢ each
Prices Subject to Change

Send \$1.00 Postage for a
FREE 1988 CATALOG

Telex: 176043

©1988 Jameco Electronics

1355 SHOREWAY RD., BELMONT, CA 94002 • FOR ORDERS ONLY 415-592-8097 • ALL OTHER INQUIRIES 415-592-8121

CIRCLE 114 ON FREE INFORMATION CARD

CAPACITORS TANTALUM

1.0μf	15V	12	1.0μf	35V	45
6.8	15V	42	2.2	35V	19
10	15V	45	4.7	35V	39
22	15V	99	10	35V	69

DISC

10μf	50V	05	001μf	50V	05
22	50V	05	005	50V	05
33	50V	05	01	50V	07
47	50V	05	05	50V	07
100	50V	05	.1	12V	10
220	50V	05	.1	50V	12

MONOLITHIC

.01μf	50V	.14	1/4μf	50V	18
.047μf	50V	.15	.47μf	50V	25

ELECTROLYTIC

RADIAL		AXIAL			
1/4μf	25V	14	1/4μf	50V	14
4.7	50V	11	10	50V	16
10	50V	11	22	16V	14
47	35V	13	47	50V	19
100	16V	15	100	35V	19
220	35V	20	470	50V	29
470	25V	30	1000	16V	29
2200	16V	70	2200	16V	70
4700	25V	1.45	4700	16V	1.25

RESISTOR NETWORKS

SIP	10 PIN	9 RESISTOR	69
SIP	8 PIN	7 RESISTOR	59
DIP	16 PIN	8 RESISTOR	1.09
DIP	16 PIN	15 RESISTOR	1.09
DIP	14 PIN	7 RESISTOR	99
DIP	14 PIN	13 RESISTOR	99

38 PIN CENTRONICS

ICEN36	RIBBON CABLE	3.95
CEN36	SOLDER CUP	1.85
ICEN36/F	RIBBON CABLE	4.95
CEN36PC	Rt Angle PC Mount	1.85

EDGE CARD CONNECTORS

100 Pin	ST	S-100	125	3.95
100 Pin	WW	S-100	125	4.95
62 Pin	ST	IBM PC	100	1.95
50 Pin	ST	APPLE	100	2.95
44 Pin	ST	STD	156	1.95
44 Pin	WW	STD	156	4.95

BYPASS CAPACITORS

1.0μf CERAMIC DISC 100/\$5.00
 .01μf MONOLITHIC 100/\$10.00
 .1μf CERAMIC DISC 100/\$6.50
 1μf MONOLITHIC 100/\$12.50

25 PIN D-SUB GENDER CHANGERS \$7.95



EMI FILTER \$4.95 LINE CORDS

2 conductor 39c
 3 conductor 99c
 3 conductor w/female socket \$1.49

VOLTAGE REGULATORS

7805T	.49	7812K	1.39
7808T	.49	7905K	1.69
7812T	.49	7912K	1.49
7815T	.49	78L05	.49
7905T	.59	78L12	.49
7908T	.59	79L05	.69
7912T	.59	79L12	1.49
7915T	.59	LM323K	4.79
7805K	1.59	LM338K	6.95

SOLDER STATION

UL APPROVED

- ADJUSTABLE HEAT SETTING W/ TIP TEMP READOUT
- QUICK HEATING & RECOVERY
- RANGE: 200°-900°F

\$49.95

EXTENDER CARDS FOR IBM

EXT-8088 \$29.95
 EXT-80286 \$39.95



SHORTING BLOCKS 5/\$1.00



WIREWRAP PROTOTYPE CARDS

FR-4 EPOXY GLASS LAMINATE
 GOLD-PLATED EDGE CARD FINGERS
 SILK SCREENED LEGENDS
 MOUNTING BRACKET

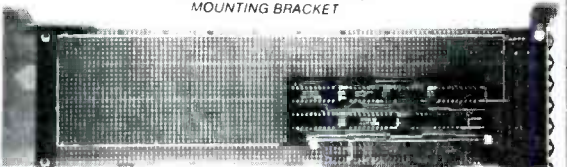

FOR PS/2

JDR-PR32 32 BIT PROTOTYPE CARD \$69.95
 JDR-PR16 16 BIT WITH I/O DECODING CIRCUITRY \$49.95
 JDR-PR16-PK PARTS KIT FOR ABOVE \$15.95
 JDR-PR16V EXTENDED CONNECTORS FOR VIDEO APPLICATIONS \$39.95

FOR XT

IBM-PR1 \$27.95 WITH +5V AND GROUND PLANE
 IBM-PR2 \$29.95 AS ABOVE WITH DECODING LAYOUT

FOR AT

JDR-PR10 16 BIT WITH DECODING LAYOUT \$34.95
 JDR-PR10-PK PARTS KIT FOR ABOVE \$12.95

WHY THOUSANDS CHOOSE JDR

- QUALITY MERCHANDISE
- COMPETITIVE PRICES
- MOST ORDERS SHIPPED IN 24 HOURS
- FRIENDLY, KNOWLEDGEABLE STAFF
- 30-DAY MONEY BACK GUARANTEE
- TOLL FREE TECHNICAL SUPPORT
- EXCELLENT CUSTOMER SERVICE

CALL FOR VOLUME QUOTES

SOLDERLESS BREADBOARDS

WBU-D	100 TIE POINTS	2.95
WBU-T	630 TIE POINTS	6.95
WBU-204-3	1360 TIE POINTS	17.95
WBU-204	1660 TIE POINTS	24.95
WBU-206	4390 TIE POINTS	29.95
WBU-208	3220 TIE POINTS	39.95

PAGE WIRE WRAP WIRE

PRECUT ASSORTMENT IN ASSORTED COLORS \$27.50

100ea: 5", 6", 6.5", 7"
 250ea: 2.5", 4.5", 5.0", 5.5"
 500ea: 3.0", 3.5", 4.0"

SPOOLS

100 feet	\$4.30	250 feet	\$7.25
500 feet	\$13.25	1000 feet	\$21.95

Please specify color: Blue, Black, Yellow or Red

IDC CONNECTORS/RIBBON CABLE

DESCRIPTION	ORDER BY	CONTACTS					
		10	20	26	34	40	50
SOLDER HEADER	IDHxxS	.82	1.29	1.68	2.20	2.58	3.24
RIGHT ANGLE SOLDER HEADER	IDHxxSR	.85	1.35	1.76	2.31	2.72	3.39
WIREFRAP HEADER	IDHxxW	1.86	2.98	3.84	4.50	5.28	6.63
RIGHT ANGLE WIREFRAP HEADER	IDHxxWR	2.05	3.28	4.22	4.45	4.80	7.30
RIBBON HEADER SOCKET	IDSxx	.63	.89	.95	1.29	1.49	1.69
RIBBON HEADER	IDMxx	---	5.50	6.25	7.30	7.50	8.50
RIBBON EDGE CARD	IDExx	.85	1.25	1.35	1.75	2.05	2.45
10' GREY RIBBON CABLE	RCxx	1.60	3.20	4.10	5.40	6.40	7.50

FOR ORDERING INSTRUCTIONS, SEE D-SUBMINIATURE CONNECTORS, BELOW

SPECTRONICS CORPORATION EPROM ERASERS

Model	Timer	Chip Capacity	Intensity (uW Cm ²)	Unit Cost
PE-140	NO	9	8,000	\$89
PE-140T	YES	9	8,000	\$139
PE-240T	YES	12	9,600	\$189

DATARASE

- ERASES 2 EPROMS IN 10 MINUTES
- VERY COMPACT, NO DRAWER
- THIN METAL SHUTTER PREVENTS UV LIGHT FROM ESCAPING

\$34.95



D-SUBMINIATURE CONNECTORS

DESCRIPTION	ORDER BY	CONTACTS						
		9	15	19	25	37	50	
SOLDER CUP	MALE	DBxxP	.45	.59	.69	.69	1.35	1.85
	FEMALE	DBxxS	.49	.69	.75	.75	1.39	2.29
RIGHT ANGLE PC SOLDER	MALE	DBxxPR	.49	.69	---	.79	2.27	---
	FEMALE	DBxxSR	.55	.75	---	.85	2.49	---
WIREFRAP	MALE	DBxxPWW	1.69	2.56	---	3.89	5.60	---
	FEMALE	DBxxSWW	2.76	4.27	---	6.84	9.95	---
IDC RIBBON CABLE	MALE	IDBxxP	1.39	1.99	---	2.25	4.25	---
	FEMALE	IDBxxS	1.45	2.05	---	2.35	4.49	---
HOODS	METAL	MHOODxx	1.05	1.15	1.25	1.25	---	---
	GREY	HOODxx	.39	.39	---	.39	.69	.75

ORDERING INSTRUCTIONS: INSERT THE NUMBER OF CONTACTS IN THE POSITION MARKED "xx" OF THE ORDER BY PART NUMBER LISTED. EXAMPLE: A 15 PIN RIGHT ANGLE MALE PC SOLDER WOULD BE DB15PR

MOUNTING HARDWARE 59¢

LIGHT EMITTING DIODES LED DISPLAYS

FND-357(559)	COM CATHODE	362"	1.25
FND-500(503)	COM CATHODE	5"	1.49
FND-507(510)	COM ANODE	5"	1.49
MAN-72	COM ANODE	3"	.99
MAN-74	COM CATHODE	3"	.99
TIL-313	COM CATHODE	3"	.45
TIL-311	4x7 HEX W/ LOGIC	270"	10.95

DIFFUSED LEDs

JUMBO RED	T1 1/4	1.99	100-UP
JUMBO GREEN	T1 1/4	.10	.09
JUMBO YELLOW	T1 1/4	.14	.12
MOUNTING HDW	T1 1/4	.14	.12
MINI RED	T1	.10	.09

3 VOLT LITHIUM BATTERY \$1.95 HOLDER \$1.49



SOCKET-WRAP 1.0™

- SLIPS OVER WIRE WRAP PINS
- IDENTIFIES PIN NUMBERS ON WRAP SIDE OF BOARD
- CAN WRITE ON THE PLASTIC, SUCH AS AN IC #

PINS	PART #	PCK. OF	PRICE
8	IDWRAP 08	10	1.95
14	IDWRAP 14	10	1.95
16	IDWRAP 16	10	1.95
18	IDWRAP 18	5	1.95
20	IDWRAP 20	5	1.95
22	IDWRAP 22	5	1.95
24	IDWRAP 24	5	1.95
28	IDWRAP 28	5	1.95
40	IDWRAP 40	5	1.95

PLEASE ORDER BY NUMBER OF PACKAGES (PCK. OF)

SWITCHES

SPDT	MINI-TOGGLE ON-OFF	1.25
DPDT	MINI-TOGGLE ON-OFF	1.50
DPDT	MINI-TOGGLE ON-OFF-ON	1.75
SPST	MINI-PUSHBUTTON N.O.	.39

DIP SWITCHES

4 position	85	7 position	.95
5 position	90	8 position	.95
6 position	90	10 position	1.29

"SNAPABLE" HEADERS

CAN BE SNAPPED APART TO MAKE ANY SIZE HEADER, ALL WITH 1" CENTERS

1x40	STRAIGHT LEAD	.99
1x40	RIGHT ANGLE LEAD	.49
2x40	2 STRAIGHT LEADS	2.49
2x40	2 RIGHT ANGLE LEADS	2.99

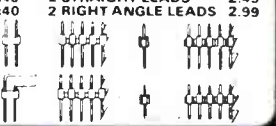

JDR MICRODEVICES, 110 KNOWLES DRIVE, LOS GATOS, CA 95030
 LOCAL (408) 866-6200 FAX (408) 378-8927 TELEX 171-110

RETAIL STORE: 1256 SOUTH BASCOM AVE., SAN JOSE, CA (408) 947-8881
 HOURS: M-F 10-7 SAT. 9-5 SUN. 12-4



ORDER TOLL FREE 800-538-5000

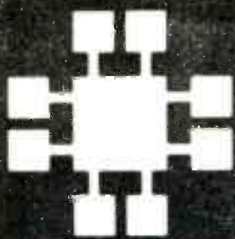

JDR Microdevices®

Complete customer satisfaction... superior service... friendly, knowledgeable personnel
quality merchandise... providing the best values in leading edge technology.

PROMETHEUS 2400 BAUD MODEM

\$129⁹⁵
NEW LOW PRICE!



IT'S TIME TO TRADE UP NOW THAT JDR BREAKS THE PRICE BARRIER ON 2400 BAUD MODEMS

- AUTO DIAL ANSWER
- SELF TEST ON POWER-UP
- TOUCHTONE OR PULSE DIALING
- HAYES & BELL SYSTEMS COMPATIBLE
- FULL OR HALF DUPLEX
- MIRROR II COMMUNICATIONS SOFTWARE INCLUDED

MCT-241

MCT-121 1200 BAUD 1/2 CARD \$ 69.95

EXTERNAL MODEMS

MCT-12E 1200 BAUD \$ 99.95
MCT-24E 2400 BAUD \$169.95

COMPUTER CASES

ATTRACTIVE, STURDY STEEL CASES FIT THE POPULAR SIZED MOTHERBOARDS AND INCLUDE SPEAKERS, FACEPLATES, EXPANSION SLOTS, FRONT PANEL KEYLOCKS, LED INDICATORS AND ALL NECESSARY HARDWARE.



XT STYLE FLIP-TOP \$34.95
XT STYLE SLIDE-TOP \$39.95
AT STYLE SLIDE-TOP \$89.95
JR. AT STYLE FLIP-TOP \$149.95
■ INCLUDES 150 WATT POWER SUPPLY

POWER SUPPLIES

FOR IBM XT COMPATIBLE \$59.95

- UL APP. 135 WATTS
- +5V 15A, +12V 4.2A
- -5V .5A, -12V .5A

PS-135

PS-150 150W MODEL \$69.95

FOR IBM AT COMPATIBLE \$89.95

- 200 WATTS
- +5V 22A, +12V 8A
- -5V .5A, -12V .5A

PS-200



DIABLO PRINTER \$279⁹⁵

- LETTER QUALITY AT 20 CPS, 132 COLS
- 10, 12, 15 PITCH & PROPORTIONAL SPACING
- SERIAL & PARALLEL INTERFACE
- AUTO PAPER LOAD, FRICTION FEED
- FULL XEROX WARRANTY



CENTRONICS LASER \$1195 PRINTER

NEAR TYPESET QUALITY
AFFORDABLE AT LAST

- 8 PAGES PER MINUTE ■ 300 DPI RESOLUTION!
- 1 YEAR WARRANTY ■ CHOICE OF EMULATION BOARDS
- MULTI-PRINTER EMULATION BOARD:**
EPSON FX-80 EMULATION—NOTHING ELSE REQUIRED
IBM PC GRAPHICS, PROPRINTER & DIABLO 630
EMULATION REQUIRES ADDITIONAL FONT CARD
- HP LJ+ EMULATION BOARD:**
HP LASERJET EMULATION—3 RESIDENT FONTS &
2 PITCHES ADDITIONAL FONT CARD AVAILABLE

1.5MB RAM CARD \$139.95
EXTRA FONT CARDS \$199.95
TONER CARTRIDGES \$59.95
PFS FIRST PUBLISHER \$99.95



IBM COMPATIBLE KEYBOARDS FULL ONE YEAR WARRANTY

IBM ENHANCED STYLE LAYOUT \$79.95
■ AUTONSENSE FOR XT OR AT COMPATIBLES
■ LED INDICATORS ■ AUTO REPEAT FEATURE
■ SEPARATE CURSOR PAD
MCT-5339

IBM AT STYLE LAYOUT \$59.95
■ SOFTWARE AJTONSENSE FOR XT OR AT COMPATIBLES
■ LED INDICATORS ■ AUTO REPEAT FEATURE
MCT-5060

MAXI-SWITCH KEYBOARDS
ENHANCED STYLE LAYOUT \$84.95

■ STANDARD ENHANCED KEYBOARD LAYOUT
■ TACTILE FEEDBACK
■ LIGHTED NUM. CAPS, AND SCROLL LOCK
■ NUMERIC & CJRSOR KEYPADS, 12 "F" KEYS
MAX-5339
MAX-5060 MAXI-SWITCH, AT STYLE \$64.95

SAMSUNG MONOCHROME MONITOR

\$129⁹⁵

- IBM COMPATIBLE TTL INPUT
- 12" NON-GLARE, LOW DISTORTION AMBER SCREEN
- 720 X 350 RESOLUTION
- SWIVEL BASE



NEC MULTISYNC \$599.95

- ORIGINAL CGA/EGA/PGA COMPATIBLE MONITOR
- AUTO FREQUENCY ADJUSTMENT
- RESOLUTION AS HIGH AS 800 X 560

CASPER EGA \$399.95

- 15.75/21.85 KHz SCANNING FREQUENCIES
- 640 X 200/350 RESOLUTION ■ .31 MM DOT PITCH
- 14" BLACK MATRIX SCREEN ■ 16 COLORS

CASPER RGB \$279.95

- COLOR/GREEN/AMBER SWITCH ■ 39MM DOT PITCH
- 640 X 240 RESOLUTION ■ 14" NON-GLARE SCREEN
- RGB/IBM COMPATIBLE ■ CABLE INCLUDED

SAKATA
MONOCHROME \$69.95

- IBM COMPATIBLE TTL INPUT
- 12" NON-GLARE SCREEN
- CABLE FOR IBM PC INCLUDED

MONITOR STANDS

MODEL MS-100 \$12.95

- TILTS AND SWIVELS
- STURDY PLASTIC CONSTRUCTION

MODEL MS-200 \$39.95

- TILTS AND SWIVELS ■ BUILT-IN SURGE SUPPRESSOR
- INDEPENDENTLY CONTROLS UP TO 5 AC OUTLETS

LOGITECH MOUSE \$79⁹⁵



PC MAGAZINE'S EDITORS CHOICE
ALL MODELS HAVE SERIAL SUPPORT (COM1 COM2), 200
D.P.I. RESOLUTION, LOTUS 1-2-3 SHELL, SELF-INSTALLING
SOFTWARE AND "POINT EDITOR"

SERIAL MOUSE W/PC PAINTBRUSH \$99.95
BUS MOUSE W/PC PAINTBRUSH \$99.95
BUS MOUSE W/PC PAINTBRUSH/CAD \$149.95

3.5" FLOPPY DISK DRIVE \$129⁹⁵



- IBM COMPATIBLE DRIVE ■ AT AND XT VERSIONS AVAILABLE
- FORMATS TO 720K, DS/QD UNDER DOS 3.2
- MEDIA COMPATIBLE WITH PS/2 & LAPTOP MACHINES
- INCLUDES HARDWARE FOR MOUNTING IN 5.14" SLOT
- QUIET OPERATION
- FDD-3.5X (FOR XT)
- FDD-3.5A (FOR AT)

Seagate

**60 MB
NOW
\$499⁰⁰**

WAS \$649 AN INCREDIBLE PRICE REDUCTION! SAVE \$150 AND GET MORE MEGABYTES PER DOLLAR THAN EVER BEFORE. THE ST-277 IS AN RLL DRIVE WITH A FAST 40 MS ACCESS TIME!
ST-277

WITH MCT-RLL CONTROLLER \$549.00
WITH MCT-ATFH CONTROLLER \$639.00

1/2 HEIGHT DRIVES

20 MB, 65 MS, ST-225 \$225.00
WITH MCT-HOC CONTROLLER \$269.00
WITH MCT-ATFH CONTROLLER \$339.00

30 MB RLL, 65 MS, ST-238 \$249.00
WITH MCT-RLL CONTROLLER \$299.00
WITH MCT-ATFH-RLL CONTROLLER \$389.00

40 MB, 40 MS, ST-251 \$429.00
WITH MCT-HDC CONTROLLER \$469.00
WITH MCT-ATFH CONTROLLER \$539.00

FULL HEIGHT DRIVES

30 MB, 40 MS, ST-4038 \$559.00
80 MB, 28 MS, ST-4096 \$895.00

DISK DRIVES

1.44 MB 3 1/2" DRIVE 149.95
ULTRA HIGH DENSITY
ALSO WORKS WITH 720K DISKS
FDD-1.44X—BLACK *DD-1.44A—BEIGE

1/2 HEIGHT FLOPPY DISK DRIVES

5 1/4" TEAC FD-55B DS/DD 360K \$59.95
5 1/4" TEAC FD-55G DS/HD 1.2M \$119.95
5 1/4" FUJITSU M2551A DS/DD 360K \$89.95
5 1/4" FUJITSU M2553K DS/HD 1.2M \$119.95
5 1/4" DS/DD 360K \$69.95
5 1/4" DS/HD 1.2M \$119.95
3 1/2" MITSUBISHI DS/DD (AT OR XT) \$129.95

**ARCHIVE XL
TAPE BACK-UP**

\$369⁹⁵

- BACK UP 40 MB IN 40 MINUTES!
- EASY-TO-USE MENU DRIVEN SOFTWARE
- USES STANDARD QIC DATA FORMAT
- FULL & INCREMENTAL BACK-UP
- PARTIAL & FULL RESTORE

AR 5240 XT —FOR XT S & AT S
AR 5540 AT —AT S ONLY. 2X FASTER TAPE NOT INCLUDED
TAPE CARTRIDGE—4J MB \$24.95



**20MB HARD DISK
ON A CARD**

\$349

- SAVES SPACE AND REDUCES POWER CONSUMPTION
- IDEAL FOR PC'S WITH FULL HEIGHT FLOPPIES
- LEAVES ROOM FOR A HALF LENGTH CARD IN ADJACENT SLOT



“
I'M WRITING TO EXPRESS MY PLEASURE WITH THE PC-XT TYPE COMPUTERS BUILT FROM MCT COMPONENTS THAT WE HAVE OBTAINED FROM YOUR COMPANY. AFTER 3 YEARS OF DAILY USAGE I AM EXTREMELY PLEASED WITH THE LEVEL OF COMPATIBILITY AND PERFORMANCE. WITH A RECENT PURCHASE, I WAS ELATED WITH THE PROMPT MANNER IN WHICH OUR ORDER WAS HANDLED. AFTER DEALING WITH OTHER MAIL ORDER FIRMS, I HAVE FOUND ONLY JDR AND 2 OTHER SOFTWARE VENDORS HELPFUL AND RELIABLE. KEEP UP THE EXCELLENT WORK.
”

J.R.D.
OMAHA, NE.

BARGAIN HUNTER'S CORNER

**2 BUTTON
LOGITECH MOUSE**

- DEVICE DRIVER SOFTWARE INCLUDED
- CONNECTS TO STANDARD SERIAL PORT
- RELIABLE, ACCURATE OPTO-MECHANICAL DESIGN
- 90 DAY WARRANTY

**ONLY
\$49.95**

SPECIAL ENDS 6/30/88

**INTERFACE CARDS FROM
MODULAR CIRCUIT TECHNOLOGY**

DISPLAY ADAPTORS

MONOCHROME GRAPHICS CARD \$59.95
TRUE HERCULES COMPATIBILITY. SUPPORTS LOTUS 123
PARALLEL PRINTER PORT CONFIGURES AS CPT1 OR LPT2 ■ USES VLSI CHIPS TO ENSURE RELIABILITY
MCT-MGP

ENHANCED GRAPHICS ADAPTOR \$149.95
100% IBM COMPATIBLE. PASSES IBM EGA DIAGNOSTICS
256K OF VIDEO RAM ALLOWS 640 X 350 IN 16 OF 64 COLORS ■ COMPATIBLE WITH COLOR AND MONOCHROME ADAPTORS
MCT-EGA

COLOR GRAPHICS ADAPTOR \$49.95
COMPATIBLE WITH IBM GRAPHICS STANDARDS
SUPPORTS RGB, COLOR & COMPOSITE MONOCHROME
640 320 X 200 RESOLUTION, LIGHT PEN INTERFACE
MCT-CG

MULTIFUNCTION CARDS

MONOGRAPHICS MULTI I/O \$119.75
TOTAL SYSTEM CONTROL FROM A SINGLE SLOT!
CTRL 2 FLOPPY S. SERIAL, PARALLEL, GAME PORT.
CLOCK/CAL ■ RUN COLOR GRAPHICS SOFTWARE ON A MONOCHROME MONITOR
MCT-MGM10

MULTI I/O FLOPPY CONTROLLER \$79.95
A PERFECT COMPANION FOR OUR MOTHERBOARDS
SUPPORTS UP TO 2 360K FLOPPIES, 720K WITH DOS 3.2
SERIAL, PARALLEL, GAME PORT, CLOCK/CALENDAR
MCT-MIO
MIO-SERIAL—2ND SERIAL PORT \$15.95

MULTI I/O CARD \$59.95
USE WITH MCT-FH FOR A MINIMUM OF SLOTS USED
SERIAL PORT, CLOCK/CALENDAR WITH BATTERY BACK-UP ■ PARALLEL PRINTER PORT ADDRESSABLE AS LPT1 OR LPT2
MCT-IO

AT MULTIFUNCTION CARD \$139.95
ADDS UP TO 3 MB OF RAM TO YOUR AT
USER EXPANDABLE TO 15 MB, OR 3 MB WITH OPTIONAL PIGGYBACK BOARD (0 K INSTALLED) ■ INCLUDES SERIAL AND PARALLEL PORT
MCT-ATMF-MC PIGGYBACK BOARD \$29.95
ATMF SERIAL-2ND SERIAL PORT \$24.95

CIRCLE 179 ON FREE INFORMATION CARD

AT MULTI I/O CARD \$59.95
USE WITH MCT-ATFH FOR MINIMUM OF SLOTS USED
SERIAL, PARALLEL AND GAME PORTS ■ USES 16450 SERIAL SUPPORT CHIPS FOR HIGH SPEED OPS
MCT-ATIO
ATIO-SERIAL—2ND SERIAL PORT \$24.95

MEMORY CARDS

576K RAM CARD \$59.95
A CONTIGUOUS MEMORY SOLUTION IN A SHORT SLOT
USER SELECTABLE CONFIGURATION UP TO 576K
USES 6-K & 256K RAM CHIPS (ZERO K INSTALLED)
MCT-RAM

EXPANDED MEMORY CARD \$129.95
2 MB OF LOTUS INTEL MICROSOFT COMPATIBLE MEMORY FOR AN XT ■ CONFORMS TO LOTUS INTEL EMS ■ USER EXPANDABLE TO 2 MB ■ CAN BE USED AS EXPANDED OR CONVENTIONAL MEMORY, RAMDISK AND SPOOLER
MCT-EMS
MCT-ATEMS AT COMPATIBLE VERSION \$139.95

DRIVE CONTROLLERS

FLOPPY DISK CONTROLLER \$29.95
QUALITY DESIGN FOR SINGLE SLOT CONTROL OF 4 FLOPPY S ■ INTERFACES UP TO 4 FDD'S TO AN IBM PC OR COMPATIBLE ■ SUPPORTS BOTH DS/DD AND DS/QD WITH DOS 3.2
MCT-FDC

1.2 MB FLOPPY CONTROLLER \$69.95
ADD VERSATILITY AND CAPACITY TO YOUR XT
SUPPORTS 2 DRIVES, BOTH MAY BE 360K OR 1.2 MB
ALLOWS DATA TO FLOW FREELY FROM XT'S TO AT'S
MCT-FDC-1.2

FLOPPY/HARD CONTROLLER \$139.95
XT SYSTEM STARVED FOR SLOTS? THIS CARD FREES ONE UP ■ INTERFACES UP TO 2 FDD'S & 2 HDD S, CABLING FOR 2 FDD, 1 HDD ■ SUPPORTS BOTH DS/DD & DS/QD WITH DOS 3.2
MCT-FH

ATFH CONTROLLER \$149.95
FLOPPY/HARD DISK CONTROL IN A TRUE AT DESIGN
SUPPORTS UP TO 2 360K/720K/1.2MB FDD'S AS WELL AS 2 HDD'S USING STANDARD CONTROL TABLES
MCT-ATFH

RLL DISK CONTROLLER \$199.95
IMPROVE SPEED AND STORAGE OF YOUR AT COMPATIBLE ■ SUPPORTS UP TO 2 RLL HARD DISCS AND 2 FLOPPY DRIVES ■ SUPPORTS 360/720/1.2 MB FLOPPIES IN 5.25" & 3.5"
MCT-ATFH-RLL

intel



**INBOARD 386/PC
\$895.00**

UPGRADE YOUR XT TO A 386 FOR LESS THAN \$1000
16 MHZ PROCESSOR REPLACES 8088 ■ 1 MB INSTALLED ■ EXPAND TO 3MB WITH PIGGYBACK CARD
5 YR WARRANTY

INBOARD 386/AT \$1199.95
ABOVE BOARD PS 286 \$399.95
ABOVE BOARD 286 \$369.95

JDR MICRODEVICES, 110 KNOWLES DRIVE, LOS GATOS, CA 95030
LOCAL (408) 866-6200 FAX (408) 378-8927 TELEX 171-110

ORDER TOLL FREE 800-538-5000

COPYRIGHT 1988 JDR MICRODEVICES



CONTINENTAL U.S. AND CANADA

BUILD YOUR OWN SYSTEM



**OVER 20,000 JDR SYSTEMS
HAVE ALREADY BEEN BUILT.
EASY TO ASSEMBLE IN JUST 2
HOURS WITH A SCREWDRIVER.
SAVE MONEY AND LEARN
ABOUT YOUR COMPUTER AT
THE SAME TIME.**

**12 MHZ AT
COMPATIBLE
\$1034²⁰**

- 12 MHZ BABY AT MOTHERBOARD
- 256K RAM MEMORY
- MINI-AT CASE W/POWER SUPPLY
- AT STYLE KEYBOARD
- 1.2 MB FLOPPY DRIVE
- FLOPPY/HARD DRIVE CONTROLLER
- MONOCHROME MONITOR
- GRAPHICS ADAPTOR

**10 MHZ XT
COMPATIBLE
\$589⁰⁰**

- INCLUDES SERIAL PORT, 2 PARALLEL PORTS, CLOCK/CALENDAR AND GAME ADAPTOR. RUNS COLOR GRAPHICS ON A MONOCHROME MONITOR
- MOTHERBOARD
 - 256K RAM MEMORY
 - 135 WATT POWER SUPPLY
 - FLIP-TOP CASE
 - AT STYLE KEYBOARD
 - 360K FLOPPY DRIVE
 - MONOGRAPHS I/O CARD
 - MONOCHROME MONITOR

**16 MHZ
1 MB 386
\$2298⁶⁵**

- MYLEX 386 MOTHERBOARD
- 1 MB RAM ON BOARD
- 200 WATT POWER SUPPLY
- AT STYLE CASE
- ENHANCED AT STYLE KEYBOARD
- 1.2 MB FLOPPY DRIVE
- AT FLOPPY/HARD CONTROLLER
- MONOCHROME MONITOR
- MONOGRAPHS CARD

**VIDEO
INSTRUCTIONS
\$4⁹⁵
WITH KIT PURCHASE
IT'S A JDR
EXCLUSIVE!
EASY TO FOLLOW
20 MINUTE VHS
TAPE SHOWS YOU
STEP-BY-STEP
HOW TO BUILD
AN XT COMPATIBLE
SYSTEM.
WITHOUT KIT
\$19.95**

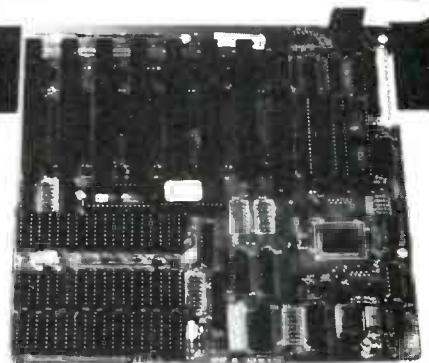

MOTHERBOARDS

TURBO 4.77/8 MHZ \$99.95 12 MHZ MINI 80286 \$399.95

- 4.77 OR 8 MHZ OPERATION WITH 8088-2 & OPTIONAL 8087-2 CO-PROCESSOR
- FRONT PANEL LED SPEED INDICATOR AND RESET SWITCH SET SUPPORTED
- CHOICE OF NORMAL/TURBO MODE OR SOFTWARE SELECT PROCESSOR SPEED

**MCT-TURBO
MCT-XTMB STANDARD MOTHERBOARD \$87.95**

- 6 MHZ, 10 MHZ (0/1 WAIT STATE), 12 MHZ (1 WAIT STATE)
- USES ZYMO5 ASIC'S FOR LESS CHIPS, GREATER RELIABILITY
- SUPPORTS 256K-1024K MEMORY
- RE-CHARGEABLE HIGH CAPACITY NI-CAD BATTERY
- 6 16-BIT SLOTS, 2 8-BIT SLOTS
- MOUNTS IN STANDARD XT CASE

**MCT-BATMB-12
MCT-BATMB 6/10 MHZ MINI 80286 BOARD \$389.95**

80286 6/8 MHZ \$379.95 16 MHZ MYLEX 386 \$1649.00

- 8 SLOT (2 EIGHT BIT, 6 SIXTEEN BIT) AT MOTHERBOARD
- HARDWARE SELECTION OF 6 OR 8 MHZ
- 1 WAIT STATE
- KEYLOCK SUPPORTED, RESET SWITCH, FRONT PANEL LED INDICATOR
- SOCKETS FOR 1 MB OF RAM AND 80287
- BATTERY BACKED CLOCK

MCT-ATMB

- 1 MB RAM ON BOARD
- 8 SLOTS, 2 8-BIT, 6 16-BIT
- SUPPORTS 80287 MATH CO-PROCESSOR
- SUPPORTS 80387 W/ADAPTOR
- 64 KB CACHE FOR NEAR 0 WAIT STATE
- USES AMI BIOS

**MCT-386 MB
MCT-386 MB-4 4 MB MEMORY INSTALLED \$2649.00
MCT-386 MB-MCB MATH CO-PROCESSOR
ADAPTOR BOARD \$149.00**

**10 MHZ SINGLE CHIP XT
\$129⁹⁵**

- SINGLE CHIP USES LESS POWER, IMPROVES RELIABILITY
- KEY SELECTABLE SPEED, 4.77 MHZ OR 10 MHZ
- 2-3 TIMES FASTER THAN A STANDARD
- RESET SWITCH, KEYLOCK AND SPEED/POWER INDICATORS SUPPORTED

MCT-TURBO-10

DEVELOPMENT TOOLS

**EPROM
PROGRAMMER
\$129⁹⁵**

- PROGRAMS 27XX & 27XXX EPROMS UP TO 27512
- SUPPORTS VARIOUS PROGRAMMING FORMATS AND VOLTAGES
- SPLIT OR COMBINE CONTENTS OF SEVERAL EPROMS OF DIFFERENT SIZES
- READ, WRITE, COPY, ERASE CHECK AND VERIFY
- SOFTWARE FOR HEX AND INTEL HEX FORMATS

**MCT-EPROM
MCT-EPROM-4 4 GANG PROGRAMMER \$189.00
MCT-EPROM-10 10 GANG PROGRAMMER \$299.95
MCT-PAL PAL PROGRAMMER \$269.95
MCT-MP PROCESSOR PROG. \$199.95**

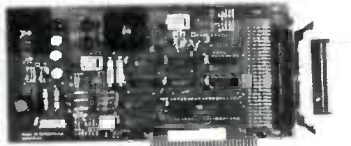

- 1 YEAR WARRANTY ON MCT PRODUCTS
- 30 DAY MONEY BACK GUARANTEE
- TOLL-FREE TECHNICAL SUPPORT
- NEXT DAY AIR SHIP AVAILABLE

JDR Microdevices®

JDR MICRODEVICES, 110 KNOWLES DRIVE, LOS GATOS, CA 95030
LOCAL (408) 866-6200 FAX (408) 378-8927 TELEX 171-110

ORDER TOLL FREE 800-538-5000

COPYRIGHT 1988 JDR MICRODEVICES



CIRCLE 180 ON FREE INFORMATION CARD

www.americanradiohistory.com

CONTINENTAL U.S. AND CANADA



1-800-344-4539 AK, Puerto Rico - 218-81-6674 - Telex - 62827914 FAX - 218-81-3380 TWX - 910508882 DIGI KEY CORP

INTEGRATED CIRCUITS

Table of integrated circuits including 7400 TTL, 74500 TTL, and 7400 CMOS. Columns include Part, Price, and Description.

1% METAL OXIDE FILM RESISTORS

Table of 1% metal oxide film resistors. Columns include Part, Price, and Description.

5% WIREWOUND RESISTORS

Table of 5% wirewound resistors. Columns include Part, Price, and Description.

DISC CAPACITORS

Table of disc capacitors. Columns include Part, Price, and Description.

5% METAL OXIDE FILM RESISTORS

Table of 5% metal oxide film resistors. Columns include Part, Price, and Description.

1% METAL OXIDE FILM RESISTORS

Table of 1% metal oxide film resistors. Columns include Part, Price, and Description.

4000 CMOS

Table of 4000 CMOS integrated circuits. Columns include Part, Price, and Description.

7400 CMOS

Table of 7400 CMOS integrated circuits. Columns include Part, Price, and Description.

TRANSFORMERS

Table of transformers. Columns include Part, Price, and Description.

PARANASCAL SERIES

Table of Paranasal series capacitors. Columns include Part, Price, and Description.

PARANASCAL SERIES

Table of Paranasal series capacitors. Columns include Part, Price, and Description.

PARANASCAL SERIES

Table of Paranasal series capacitors. Columns include Part, Price, and Description.

74500 TTL

Table of 74500 TTL integrated circuits. Columns include Part, Price, and Description.

7400 TTL

Table of 7400 TTL integrated circuits. Columns include Part, Price, and Description.

PARANASCAL SERIES

Table of Paranasal series capacitors. Columns include Part, Price, and Description.

PARANASCAL SERIES

Table of Paranasal series capacitors. Columns include Part, Price, and Description.

PARANASCAL SERIES

Table of Paranasal series capacitors. Columns include Part, Price, and Description.

PARANASCAL SERIES

Table of Paranasal series capacitors. Columns include Part, Price, and Description.

7400 CMOS

Table of 7400 CMOS integrated circuits. Columns include Part, Price, and Description.

PARANASCAL SERIES

Table of Paranasal series capacitors. Columns include Part, Price, and Description.

PARANASCAL SERIES

Table of Paranasal series capacitors. Columns include Part, Price, and Description.

PARANASCAL SERIES

Table of Paranasal series capacitors. Columns include Part, Price, and Description.

PARANASCAL SERIES

Table of Paranasal series capacitors. Columns include Part, Price, and Description.

PARANASCAL SERIES

Table of Paranasal series capacitors. Columns include Part, Price, and Description.

7400 CMOS

Table of 7400 CMOS integrated circuits. Columns include Part, Price, and Description.

PARANASCAL SERIES

Table of Paranasal series capacitors. Columns include Part, Price, and Description.

PARANASCAL SERIES

Table of Paranasal series capacitors. Columns include Part, Price, and Description.

PARANASCAL SERIES

Table of Paranasal series capacitors. Columns include Part, Price, and Description.

PARANASCAL SERIES

Table of Paranasal series capacitors. Columns include Part, Price, and Description.

PARANASCAL SERIES

Table of Paranasal series capacitors. Columns include Part, Price, and Description.

7400 CMOS

Table of 7400 CMOS integrated circuits. Columns include Part, Price, and Description.

PARANASCAL SERIES

Table of Paranasal series capacitors. Columns include Part, Price, and Description.

PARANASCAL SERIES

Table of Paranasal series capacitors. Columns include Part, Price, and Description.

PARANASCAL SERIES

Table of Paranasal series capacitors. Columns include Part, Price, and Description.

PARANASCAL SERIES

Table of Paranasal series capacitors. Columns include Part, Price, and Description.

PARANASCAL SERIES

Table of Paranasal series capacitors. Columns include Part, Price, and Description.

7400 CMOS

Table of 7400 CMOS integrated circuits. Columns include Part, Price, and Description.

PARANASCAL SERIES

Table of Paranasal series capacitors. Columns include Part, Price, and Description.

PARANASCAL SERIES

Table of Paranasal series capacitors. Columns include Part, Price, and Description.

PARANASCAL SERIES

Table of Paranasal series capacitors. Columns include Part, Price, and Description.

PARANASCAL SERIES

Table of Paranasal series capacitors. Columns include Part, Price, and Description.

PARANASCAL SERIES

Table of Paranasal series capacitors. Columns include Part, Price, and Description.

7400 CMOS

Table of 7400 CMOS integrated circuits. Columns include Part, Price, and Description.

PARANASCAL SERIES

Table of Paranasal series capacitors. Columns include Part, Price, and Description.

PARANASCAL SERIES

Table of Paranasal series capacitors. Columns include Part, Price, and Description.

PARANASCAL SERIES

Table of Paranasal series capacitors. Columns include Part, Price, and Description.

PARANASCAL SERIES

Table of Paranasal series capacitors. Columns include Part, Price, and Description.

PARANASCAL SERIES

Table of Paranasal series capacitors. Columns include Part, Price, and Description.

7400 CMOS

Table of 7400 CMOS integrated circuits. Columns include Part, Price, and Description.

PARANASCAL SERIES

Table of Paranasal series capacitors. Columns include Part, Price, and Description.

PARANASCAL SERIES

Table of Paranasal series capacitors. Columns include Part, Price, and Description.

PARANASCAL SERIES

Table of Paranasal series capacitors. Columns include Part, Price, and Description.

PARANASCAL SERIES

Table of Paranasal series capacitors. Columns include Part, Price, and Description.

PARANASCAL SERIES

Table of Paranasal series capacitors. Columns include Part, Price, and Description.

The Dig-Key name and logo are registered trademarks of Dig-Key Inc. All other trademarks are the property of their respective owners. © 1988 Dig-Key Inc.

1-800-344-4539

Circle 82 on Free Information Card

JUNE 1988

SEND FOR
FREE
1988 CATALOG...
52 PAGES

★ QUALITY PARTS ★ DISCOUNT PRICES ★ FAST SHIPPING
ALL ELECTRONICS CORP.

OPTO SENSORS

TRW# OPB815
U shaped
opto emitter
and sensor unit.
CAT# OSU-3
2 for \$1.00



Clairex#
CL1800W
U shaped unit
with flange
mount.
CAT# OSU-2
75c each

Opto emitter
and sensor on
opposite sides
of slotted
opening. P.C. mount.
CAT# ILED-U
2 for \$1.00



PHOTO TRANSISTOR

TIL-99
TO-18 CASE
CAT# TIL-99
2 for \$1.50



PHOTO DIODE

Similar to
Clairex#CLD42
Sealed TO-18 case.
CAT# PD-1
75c each



PHOTO RESISTOR ASSEMBLY

Center-tapped
photo resistor
mounted in
plastic case
(can be easily
removed). 700
ohms light, 36K dark,
1/4" diameter.
CAT# PR-4 \$1.00 each
10 for \$8.50



FLASHING L.E.D. KIT

Two L.E.D.'S
flash in
unison when
a 9 volt
battery is
attached.
Requires easy assembly,
you solder the parts to
the circuit board.
CAT# LEDKIT
\$1.50 each



LIGHT EMITTING DIODES (L.E.D.)

STANDARD JUMBO LED
DIFFUSED
T 1-3/4 size



RED 10 for \$1.50
CAT# LED-1 100 for \$13.00
1000 for \$110.00

GREEN 10 for \$2.00
CAT# LED-2 100 for \$17.00
1000 for \$150.00

YELLOW 10 for \$2.00
CAT# LED-3 100 for \$17.00
1000 for \$150.00

**WE STOCK OVER 4000 ITEMS
CALL OR WRITE FOR OUR FREE
CATALOG OF PARTS!**

RESISTORS • CAPACITORS • DIODES • CABLES •
BRIDGE RECTIFIERS • CHOKE COILS • CRIMP
CONNECTORS • SUB MINATURE D CONNECTORS •
CRYSTALS • LAMPS • HEAT SINKS • I.C.'S
• TRANSISTORS • MOTORS • PROTO BOARDS •
POTENTIOMETERS • POWER SUPPLIES • JACKS
• PLUGS • SWITCHES • PERF BOARD • FANS •
FUSES • SHRINK TUBING • TIE WRAPS •
KEYPADS • VIDEO ACCESSORIES • TOOLS
• TRANSFORMERS • TELEPHONE ACCESSORIES
• S.C.R.'S • RELAYS • WIRE • I.C. SOCKETS
• RIBBON CABLE • CRYSTALS • CIRCUIT
BREAKERS • TRANSDUCERS • VOLTAGE
REGULATORS • AND MANY OTHER ITEMS.....

SWITCHING POWER SUPPLY

Compact, well regulated
switching power supply
designed to power Texas In-
strument computer equipment.
INPUT: 14-25 Vac @ 1 Amp
OUTPUT: +5 Vdc @ 1.2 Amp, -5 Vdc @ 200 ma., 12
Vdc @ 350 ma. SIZE: 4 3/4" square. Includes 18 Vac
@ 1 Amp wall transformer designed to operate this
power supply. **CAT# PS-TX** \$5.00 each
10 for \$45.00

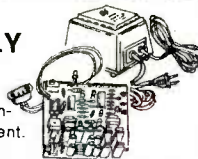

WALL TRANSFORMERS

ALL PLUG
DIRECTLY
INTO
120 VAC
OUTLET



6 Vdc @ 200 ma. \$2.25
CAT# DCTX-620
6 Vdc @ 750 ma. \$3.50
CAT# DCTX-675
9 Vdc @ 250 ma. \$2.50
CAT# DCTX-925
12 Vac @ 930 ma. \$3.50
CAT# ACTX-1293
18 Vac @ 1 Amp. \$3.50
CAT#ACTX-1885

PROTO BOARD



Large enough to
design most
experimental circuits.
This proto board
measures
6 3/4" X 2 1/2".
Contains main board
and two power buss
strips.
CAT# PB-101
\$11.00 each

WATER TIGHT ENCLOSURE

ROSE# 02081905
Molded fiberglass enclosure
with neoprene gasket.
2" X 3" X 7 1/2". Light blue.



CAT# WP-905 \$7.50 each

TRANSISTORS

CAT#	TYPE	CASE	PRICE
PN2222	NPN	TO-92	5 for .75
2N2904	PNP	TO-5	3 for \$1.00
2N2906	PNP	TO-18	3 for \$1.00
PN2907	PNP	TO-92	5 for .75
2N3055	NPN	TO-3	\$1.00 each
PN3569	NPN	TO-92	5 for .50
2N3904	NPN	TO-92	5 for .75
2N3906	PNP	TO-92	5 for .75
2N4400	NPN	TO-92	5 for .75
2N4402	PNP	TO-92	5 for .75
2N5400	PNP	TO-92	4 for \$1.00
2N5880	PNP	TO-3	\$2.00 each
2N5882	NPN	TO-3	\$2.00 each
MJ2955	PNP	TO-3	1.50 each
MJE2955T	PNP	TO-220	.75 each
MJE3055T	NPN	TO-220	.75 each
TIP30	NPN	TO-220	.75 each
TIP31	NPN	TO-220	.75 each
TIP32	PNP	TO-220	.75 each
TIP41	NPN	TO-220	.75 each
TIP42	PNP	TO-220	.75 each
TIP121	NPN	TO-220	.75 each
TIP126	PNP	TO-220	.75 each

10 AMP SOLID STATE RELAYS



ELECTROL# S2181
CONTROL:
Rated 5.5 to 10 Vdc
(will operate on 3-32 Vdc)
LOAD:
10 Amp @ 240 Vac
2 1/4" X 1 3/4" X 7/8"
CAT# SSRLY-10B
\$9.50 each
10 for \$8.50 each
QUANTITY DISCOUNT!
25 for \$7.00 each
50 for \$6.00 each
100 for \$5.00 each

SWITCHES

MINIATURE TOGGLE SWITCHES
all rated 5 Amps

S.P.D.T.(on-on)
Solder lug terminals.
CAT# MTS-4
\$1.00 each
10 for \$9.00



S.P.D.T.(on-on)
Non threaded bushing.
P.C. mount.
CAT# MTS-40PC
75c each
10 for \$7.00



D.P.D.T.(on-on)
Solder lug terminals.
CAT# MTS-8
\$2.00 each
10 for \$19.00



SOUND ACTIVATED SWITCH

This circuit is designed to react to
high pitched sounds. Each board
contains many useful parts including
a condenser mike. Operates on
6 Vdc. **CAT# SAB** \$2.50 each



SOUND & VIDEO MODULATOR

Ti# UM1381-1.
Designed for use
with T.I. comput-
ers. Can be used
with video came-
ras, games, or
other audio/
video sources.
Built in A/B
switch enables
user to switch
from T.V. antenna without dis-
connection. Operates on chan-
nel 3 or 4. Requires 12 Vdc.
Hook up diagram included.
CAT# AVMOD \$5.00 each



GRAB BAGS

\$1.00 each

50 ASSORTED DISC CAPS.
Cut leads. Many common
values, some 500 volts.
CAT# GRABDC

ASSORTED 1/4 WATT RESISTORS
Approximately 200
pieces of assorted values
some cut leads.
CAT# GRABRE

ASSORTED PARTS
Strips of 100 assorted
parts. Each strip contains
an assortment of resis-
tors, capacitors, diodes,
coils etc. 100 parts.
CAT# GRABTR

15 VALUES OF ELECTROLYTICS
Assortment contains 15
values from 1 Mfd up.
Some with cut leads.
CAT# GRABCP

600 / 600 OHM COUPLING TRANSFORMER

600 ohm
c.t.
P.C. mount
1" centers
on mounting tabs.
1" X 3/4" X 7/8"
CAT# CPTX
\$1.25 each
10 for \$11.00

MINI PUSH BUTTON

S. P. S. T. momentary.
Push to make. 1/4"
threaded bushing.
Red button.
CAT# MPB-1
35c each • 10 for \$3.25



ITT PUSH BUTTON

ITT MDPL series. 3/4" X 1 1/2"
gray rectangular key cap.
S.P.S.T. N.O. Push to close.
RATED:
0.1amp switching,
0.25 amp
carry current. P.C. mount
CAT# PB-8 65c each
10 for \$6.00 • 100 for \$50.00



HALL EFFECT SWITCH

MICROSWITCH #4BE3
Slanted keyboard
switch with hall
effect sensor.
Snaps into 5/8"
square chassis
hole. Hall effect
sensor slides easily from
switch and can be used in
other applications.
CAT# HESW 4 for \$1.00
10 for \$2.00
100 for \$15.00



NICKEL-CAD (RECHARGEABLE) BATTERIES

AA SIZE \$2.00 each
1.25 Volts 500 mAh
CAT# NCB-AA
AA SIZE \$2.20 each
WITH SOLDER TABS
CAT# NCB-SAA
C SIZE \$4.25 each
1.2 Volts 1200 mAh
CAT# NCB-C
D SIZE \$4.25 each
1.2 Volts 1200 mAh
CAT# NCB-D



FULL WAVE BRIDGE RECTIFIERS

10 AMP 200 P.I.V.
5/8" SQUARE
CAT# FWB-1020
\$1.00 each • 10 for \$9.00
25 AMP RATING
1 1/8" SQUARE
metal epoxy filled case
200 P.I.V. \$2.50 each
CAT# FWB-251
400 P.I.V. \$3.00 each
CAT# FWB-254
600 P.I.V. \$3.50 each



STORES:
LOS ANGELES
805 S. VERMONT AVE.
LOS ANGELES, CA 90006
(213)380-8000
VAN NUYS
6228 SEPULVEDA BLVD.
VAN NUYS, CA 91411
(818)997-1808

MAIL ORDERS TO:
ALL ELECTRONICS
P.O. BOX 567
VAN NUYS, CA
91408

TELEX: TWX-5101010163
ALL ELECTRONICS
FOREIGN CUSTOMERS SEND \$1.50
POSTAGE FOR FREE CATALOG!

TOLL FREE
800-826-5432
INFO: (818)904-0524
FAX: (818)781-2653
QUANTITIES LIMITED
MINIMUM ORDERS \$10.00
CALIF. ADD SALES TAX
USA: \$3.00 SHIPPING
FOREIGN ORDERS INCLUDE
SUFFICIENT SHIPPING
NO C.O.D.

Radio Shack Parts Place™

THE BUILDER'S STORE! OVER 1000 COMPONENTS IN STOCK

Our Finest Benchtop LCD Multimeter

99⁹⁵

Low As \$15
Per Month*

- Manual or Autoranging
- Min/Max Values Can Be Stored

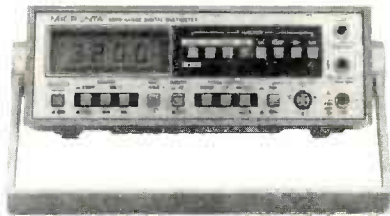

A champion performer for lab or home shop. The 31-segment analog bar graph display makes input peaks and trends easier to follow. Transistor checker measures h_{FE} (gain) and tests semiconductor junctions. Buzzer continuity checker. Measures to 1000 VDC, 750 VAC, AC/DC current to 10 amps, resistance to 30 megohms. Fused, overload protected. #22-195

Sight'n Sound

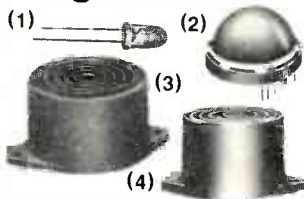

- (1) Ruby Red LED. #276-066 1.19
- (2) Jumbo Red LED. #276-064 3.49
- (3) Tri-Sound Siren. #273-072 5.95
- (4) IC Chime. #273-071 7.95

Builder Bargains

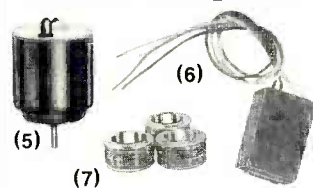

- (5) 1.5-3 VDC Motor. #273-223 79c
- (6) 1:1 Audio Transformer. For phone interconnects. #273-1374 3.49
- (7) Magnet Wire. Three-spool set—22, 26, 30 gauge. #278-1345 4.49

Data-Connector Headquarters

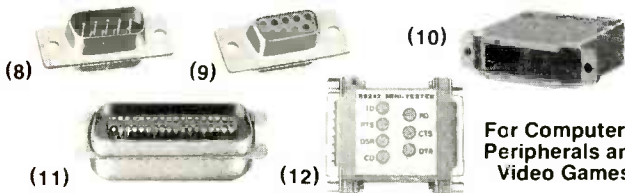

For Computers, Peripherals and Video Games

Fig	Type	Positions	Cat. No.	Each
8	Male	9	276-1537	1.49
9	Female	9	276-1538	2.49
10	Hood	9	276-1539	1.99
—	Male	25	276-1547	1.99
—	Female	25	276-1548	2.99
—	Hood	25	276-1549	1.99

- (11) Printer Connector. Solder type, 36-position. For parallel printers. #276-1534 4.99
- (12) RS-232 Inline Tester. Diagnose interface problems without repair calls. #276-1401 14.95

Coax Cable Tools

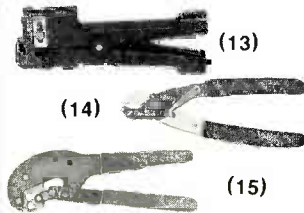

- (13) Cable Stripper. For all popular sizes. #278-240 11.95
- (14) Coax Cable Cutter. Preserves cable impedance. #278-244 4.95
- (15) Professional Crimp Tool. For all coax connectors. #278-243 12.95

The Right Stuff

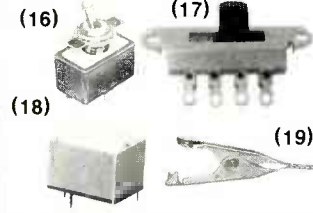

- (16) Toggle Switch Set. One DPDT, two SPST. #275-322 Set of 3/2.59
- (17) Slide Switch Kit. Assorted one or two poles/throws. #275-327 Set of 6/1.89
- (18) Micromini Relay. #275-248 2.79
- (19) Micro Clips. #270-373 10/1.59

Exciting New ICs For Hobbyists

TDA7000 FM Receiver on a Chip. Combines RF mixer, IF and demodulator stages in one IC. Just what you need to build a small, inexpensive FM band receiver, repeater monitor or public service band monitor. Mute circuit reduces spurious reception. Includes application notes. #276-1304 5.95

TDA1520A 20-Watt High-Power, High-Fidelity Audio Power Amp. Build your own quality audio amplifier! Nine-pin single inline package. Very low distortion. 20 to 20,000 Hz response. Requires 15 to 50 VDC. With data. #276-1305 5.99

Add Speech to Your Computer

SPO256-AL2 Speech Synthesizer IC. Cut 23%. Uses a stored program to produce natural sounding speech. Easy to interface with most computers. Requires 3.12 MHz crystal (special order). 28-pin DIP. Includes data. Reg. \$12.95. #276-1784 Sale 9.95

CTS256-AL2 Text-to-Speech IC. 30% Off. Preprogrammed 8-bit processor translates ASCII characters into control data for #276-1784 above. With data and schematics. Requires 10 MHz crystal (special order). 40-pin DIP. Reg. \$16.95. #276-1786 Sale 11.88

Finishing Touches

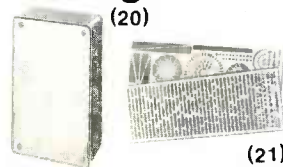

- (20) Experimenters' Boxes. Plastic with aluminum covers. Includes screws. 6 1/4 x 3 3/4 x 2". #270-627 2.39
- 3 1/4 x 2 1/8 x 1 1/8". #270-230 1.59
- 4 x 2 1/8 x 1 1/8". #270-231 1.69
- 7 3/4 x 4 3/8 x 2 3/8". #270-232 2.99
- 5 1/8 x 2 5/8 x 1 1/8". #270-233 1.99
- (21) Dry-Label Transfers. Letters, symbols, numbers. 4 sheets. #270-201 2.79

Hard-to-Find Caps

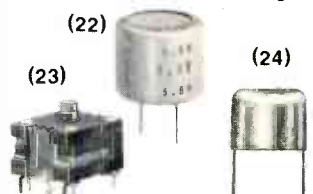

- (22) CPU/RAM Backup. Backs up CMOS microprocessors for brief AC failure. 0.1 farad, 5.5 VDC. #272-1440 2.95
- (23) Dual-Ganged 335 pF Variable. PC-mount. With knob. #272-1337 4.95
- (24) 6-50 pF Trimmers. PC/perboard-mount. #272-1340 Set of 2/1.59

Dynamic RAM

4164-64K. Warranted RAM chips are as close as your neighborhood Radio Shack. 150 ns access. Uses single 5 VDC supply. #276-2506 3.95

TMS 4256-256K. 150 ns access. Low-power design (230mV typical). Uses single 5 VDC supply. 16-pin DIP. #276-1252 6.95

Line Driver ICs For Data-Transfer

MC1488 RS-232 Quad Line Driver. Hook up terminals and remote peripherals with a simple "twisted pair" cable. 14-pin DIP with data. #276-2520 1.29

MC1489 RS-232 Quad Line Receiver. For use with above line driver. #276-2521 1.29

Operational Amps

741. General-purpose, single channel. Frequency-compensated, 8-pin DIP. #276-007 79c

1458 Dual Op Amp. Internally compensated. Low power consumption. Two independent op amps in an 8-pin DIP. Split supply 5 to 16 VDC. #276-038 99c

LM324 Quad Op Amp. Operates on 3 to 30 VDC or split 1.5 to 15 VDC supply. 14-pin DIP. #276-1711 1.29

TL082 Dual High-Performance Op Amp. Low-noise, high-2 biFET inputs. Low distortion. Split 4 to 18 VDC supply. 8-pin DIP. #276-1715 1.89

LM339 Quad Comparator. Four independent voltage comparators in a 14-pin DIP. Single 2 to 32 VDC. #276-1712 99c

LM567 Tone Detector. Touch-Tone, RC and FSK decoding. Requires 4.75 to 9 VDC. 8-pin DIP. #276-1721 1.99

Musical Chips

UMC 3482 12-Tune Melody Synthesizer IC. 33% Off. Just the thing for musical doorbells, clocks, games and phone music-on-hold. Has an on-chip audio preamp. Tunes include Happy Birthday, Row-Row-Row Your Boat and other all-time "camp" favorites. Operates on 1.5 VDC, 16-pin DIP. With data and circuit examples. Reg. \$2.99. #276-1797 Sale 1.99

AY-3-8910A Programmable Sound Generator. Cut 21%. Use with a computer to provide an astonishing variety and range of sounds! Three independent outputs. Single 5 VDC supply. 40-pin DIP. With data. Reg. \$9.95. #276-1787 Sale 7.88

CMOS and TTL ICs

All are 100% prime and include pin-out and specs.

Description	Type	Cat. No.	Each
Quad 2-Input NOR Gate	4001	276-2401	.99
Quad 2-Input NAND Gate	4011	276-2411	.99
Dual Type-D Flip Flop	4013	276-2413	1.19
Decade Counter/Divider	4017	276-2417	1.49
Inverting Hex Buffer	4049	276-2449	1.19
Quad Bilateral Switch	4066	276-2466	1.19

Description	Type	Cat. No.	Each
Quad 2-Input NAND Gate	7400	276-1801	.89
Hex Inverter	7404	276-1802	.89
Quad 2-Input AND Gate	7408	276-1822	1.29
BCD to 7-Seg. Driver	7447	276-1805	1.69
Div. by 2/5 BCD Counter	7490	276-1808	1.19

Over 1000 items in stock: Binding Posts, Books, Breadboards, Buzzers, Capacitors, Chokes, Clips, Coax, Connectors, Fuses, Hardware, ICs, Jacks, Knobs, Lamps, Multitesters, PC Boards, Plugs, Rectifiers, Resistors, Switches, Tools, Transformers, Wire, Zeners, More!

*Revolving credit from Radio Shack. Actual payment may vary depending on purchases.

Prices apply at participating Radio Shack stores and dealers

Radio Shack®
The Technology Store™

A DIVISION OF TANDY CORPORATION







CIRCLE 78 ON FREE INFORMATION CARD

ADVERTISING INDEX

RADIO-ELECTRONICS does not assume any responsibility for errors that may appear in the index below.

Free Information Number	Page	191	Dactron	75	93	Mark V. Electronics	103	
81, 192	A.I.S. Satellite	84	127	Deco Industries	84	61	Microprocessors Unltd.	92
108, 176	AMC Sales	82, 83	82	Digi-Key	115	201	Movie Time	23
—	AMCOM	102	—	Electronic Technology Today	—	—	NRI	8
107	All Electronics	116	—	Electronics Book Club	28	72	NuScope Associates	92
103	Allen, Wm B	37	111	Etronix	81	80	OCTE Electronics	84
200	Alpha Products	92	—	Firestik II	99	—	Pacific Cable	101
—	Amazing Devices	100	121	Fluke Manufacturing	39	56	Parts Express	118
106	American Design Components	106	—	Fordham Radio	CV4	101	Pomona Electronics	24
183	American Reliance	40	199	Golden Bow Systems	92	—	RCA D&SP	3
76	Associated Electronics/3M	16	—	Grantham College of Engineering	79	78	Radio Shack	117
186	Banner Technical Books	83	86	Heath	69	184, 185	Sencore	CV3, 34
98	Beckman Industrial	13, 12	65	J & W	36	74	Solid State Sales	104
85	Blue Star Industries	84	59	JDR Instruments	17	—	Star Circuits	83
109	C & S Sales	5	113, 177	JDR Microdevices	110, 111	92	Tektronix	CV2
203	CEI	100	178, 179	JDR Microdevices	112, 113	188, 189	Tektronix	23, 25
60	CIE	18	180	JDR Microdevices	114	190, 194	Tektronix	27, 40
54	Chemtronics	35	114	Jameco	108, 109	187	Tentel	37
196	Chenesko Products	84	104	Jan Crystals	39	123	Test Probes	76
—	Command Productions	81	—	Joseph Electronics	33	202	UCANDO VCR Educational Prods.	82
79	Communications Electronics	15	195	Kelvin	75	193	United Electronic Supply	77
198	Computer Heroes	92	181	Kikusui	70	66	W.S. Jenks	7
58	Cook's Institute	82	87	MCM Electronics	105	182	WPT Publications	81
197	Crystek	25	53	MD Electronics	70			



 <p>10" WOOFER Heavy duty paper cone with 20 oz. magnet. 60 watts RMS, 90 watts max. Response: 35-3,500 Hz.</p> <p>#290-083 \$18⁸⁰ \$16⁹⁰ (1-3) (4-UP)</p>	<p style="text-align: center;">FREE CATALOG</p>  <p>Call or write today for your free catalog containing speakers, semi-conductors, CATV products, tools, hardware, TV-VCR parts, and more.</p>	 <p>8" POLY WOOFER Clear ribbed polypropylene cone. 60 watts RMS, 90 watts max. power. 20 oz. magnet. 35-2500 Hz. 4-8 ohm compatible.</p> <p>#290-055 \$20⁵⁰ \$18⁹⁵ (1-3) (4-UP)</p>
 <p>HORN TWEETER 3" wide dispersion horn tweeter. 1800-15,000 Hz response. 35 watts RMS, 50 watts max. 8 ohm impedance.</p> <p>#270-050 \$6⁵⁰ \$5⁹⁰ (1-9) (10-UP)</p>	<p style="text-align: center;">CROSSOVERS</p>  <p>2-Way, 30 watt \$3⁹⁵ #260-190</p> <p>3-Way, 60 watt \$7⁵⁰ #260-200</p> <p>3-Way, 100 watt \$12⁵⁰ #260-210</p>	 <p>15" WOOFER 20 oz. magnet. 60 watts RMS, 90 watts max. 8 ohm impedance. 1 1/2" voice coil. 25-2000 Hz.</p> <p>#290-160 \$30⁹⁵ \$28⁴⁰ (1-3) (4-UP)</p>
 <p>PIEZO TWEETER Mfg. #KSN1005A, 3/4" x 3/4". No crossover required. 50 watts maximum input power.</p> <p>#270-010 \$4⁹⁵ \$3⁹⁵ (1-79) (80-UP)</p>		 <p>5 1/2" CUP MIDRANGE Tuned cup. Paper cone, 1" voice coil. 9.3 oz. magnet. 50 watts RMS, 70 watts max. Response: 320-6000 Hz. 8 ohm impedance.</p> <p>#280-020 \$11⁵⁰ \$9⁹⁵ (1-9) (10-UP)</p>

* 15 day money back guarantee. * \$10.00 minimum order. * COD orders accepted * 24 hour shipping.
* Shipping charge - UPS chart rate (\$2.50 minimum charge). Hours 8:30 a.m. - 6 p.m. EST M-F.

PARTS EXPRESS INT'L INC.
340 East First St.
Dayton, Ohio 45402



CALL TOLL FREE 1-800-338-0531
Local: (513) 222-0173

Try the

Radio Electronics

bulletin board system

(RE-BBS)

516-293-2283

The more you use it the more useful it becomes.

We support 300 and 1200 baud operation.

Parameters: 8N1 (8 data bits, no parity, 1 stop bit) or 7E1 (7 data bits, even parity, 1 stop bit).

Add yourself to our user files to increase your access.

Communicate with other R-E readers.

Leave your comments on R-E with the SYSOP.

RE-BBS

516-293-2283

Gernsback Publications, Inc.
500-B Bi-County Blvd.
Farmingdale, NY 11735
(516) 293-3000
President: Larry Steckler
Vice President: Cathy Steckler

For Advertising ONLY
516-293-3000
Larry Steckler
publisher
Arline Fishman
advertising director
Shelli Weinman
advertising associate
Lisa Strassman
credit manager
Christina Estrada
advertising assistant

SALES OFFICES

EAST/SOUTHEAST
Stanley Levitan
Eastern Sales Manager
Radio-Electronics
259-23 57th Avenue
Little Neck, NY 11362
718-428-6037, 516-293-3000

MIDWEST/Texas/Arkansas/Okla.
Ralph Bergen
Midwest Sales Manager
Radio-Electronics
540 Frontage Road—Suite 339
Northfield, IL 60093
312-446-1444

PACIFIC COAST/ Mountain States
Marvin Green
Pacific Sales Manager
Radio-Electronics
5430 Van Nuys Blvd. Suite 316
Van Nuys, CA 91401
1-818-986-2001

For the first time in the history of electronics, with the information that's provided on the component itself, you can determine if a capacitor or inductor is good or bad — anywhere without calculations, look-up tables or error.

- All capacitor and inductor tests display a simple good or bad readout to eliminate errors!
- Fully automatic/autoranged capacitor value test with percent tolerance calculator.
- Automatic 1000 volt applied leakage test with current or megohm readout. Test capacitor leakage to EIA standards.
- New dielectric absorption test eliminates interpretation.
- ESR tests eliminate tough capacitor problems.
- Fully automatic/autoranged inductance test with percent tolerance calculator.
- Patented Ringing Test gives effective Q for coils.
- Dynamically test resistance up to 1000 megohms.
- Automatic shutoff, battery test and lead zero.



NEW

**LC77 AUTO-Z™
Automatic Capacitor And
Inductor Analyzer
\$1,895 Patented**



It's like having your own Standards Engineer with you at all times.

AUTO-Z is a trademark of Sencore, Inc.

**CALL WATS Free 1-800-843-3338
In Canada Call 1-800-851-8866**

CIRCLE 184 ON FREE INFORMATION CARD

www.americanradiohistory.com

Fordham measures up

Quality • Price • Delivery

Mini-Meters with Maxi-Specs



SCOPE 3 1/2 Digit LCD Meter

- 0.5% Accuracy • DC Voltage • AC Voltage • DC Current • Resistance • Diode Test • Battery Life 300 Hrs. • Overload Protection: DC 500V, AC 350V, ohms 250V DC/AC.

Model DVM-630 **\$2995**
Our Price

Zippered carrying case CC-30 \$4.50

NEW!

SCOPE 3 1/2 Digit, LCD 8 Function with Transistor Tester

- 0.5% Accuracy • Audible continuity and diode test • 10 Amp measurement • Resistance • DC/AC Voltage.

Model DVM-632 **\$4495**
Reg. \$60.00 Our Price

Zippered carrying case CC-30 \$4.50

SCOPE 3 1/2 Digit LCD with Autoranging

- 0.5% Accuracy • Auto/Manual range selection • DC Voltage • AC Voltage • AC Current • DC Current • Resistance.

Model DVM-631 **\$4995**
Our Price

Special

Deluxe carrying case CA-92 \$9.95

SCOPE Hand-Held Digital Multimeters

- Overload protection • Auto-decimal LCD readout • Polarity indication • 300 hr. 9V battery life • Low battery indicator.

- 8 Function, 37 ranges including Transistor and Capacitance measurements

Model DVM-636 **\$6750**
Our Price



- 11 Function, 38 ranges including Logic Level Detector, Audible and Visual Continuity, Capacitance and Conductance measurements

Model DVM-638 **\$8750**
Our Price

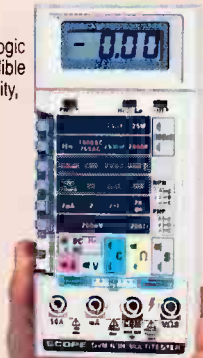

CA-92 Deluxe Padded Case for DVM meters. \$9.95
TL-216 Transistor and Capacitance Test Leads \$9.90



NEW!

SCOPE Frequency Counters
• 8-digit LED • Compact • lightweight • High performance • Automatic range and Hold function • High stability in reference oscillator.

Model FC-7011 **\$16995**
100 MHz Our Price

Model FC-7051 **\$24995**
550 MHz Our Price



FORDHAM Frequency Counter

- 10 Hz - 150 MHz Range • 7-digit LED display • VHF / HF selection • Gate time 1 sec., 5 sec. • ±1 count accuracy.

Model FC-150 **\$13990**
Our Price



NEW

FORDHAM Function Generator

- 0.5 Hz - 500 KHz in 6 ranges • Sine, square & triangle wave forms • VCA and VCF inputs • Accuracy +5% of full scale.

Model FG-202 **\$14990**
Our Price



FORDHAM Signal Tracer/Injector

- Easy to operate • VU meter • Two LED mode indicators • 1 KHz test tone • 8 ohm speaker • Test leads.

Model SE-610 **\$11990**
Our Price



FORDHAM LCR Bridge Meter

- Fully transistorized • 1 KHz signal generator • Measures resistance • Inductance • High mechanical and electrical stability • Battery operated.

Model LC-340 **\$14995**
Our Price



SCOPE Digital Capacitance Meter

- Digital LCD display • LSI-circuit • High accuracy: 100 ppm 0.5% • Broad test range • Fast sampling time • Capacitor discharge protection • Compact, lightweight design • One-hand operation.

Model DCM-602 **\$5995**
Our Price

Telephone Orders Now! EVERYDAY INCLUDING SATURDAY
Mon. - Fri. 8 a.m. - 8 p.m. EST. Sat. 9 a.m. - 3 p.m. EST

ASK FOR FREE CATALOG. Money orders, checks accepted. C.O.D.'s require 25% deposit



Fordham

Toll Free **800-645-9518**

In NY State 800-832-1446

260 Motor Parkway, Hauppauge, NY 11788

Service & Shipping Charge Schedule Continental U.S.A.

FOR ORDERS	ADD
\$25-100	\$4.50
\$101-250	\$6.00
\$251-500	\$8.00
\$501-750	\$10.50
\$751-1,000	\$12.50
\$1,001-1,500	\$16.50
\$1,501-2,000	\$20.00
\$2,001 and Up.	\$25.00